



## Self-aligning Ball Bearings

Tolerance .....	Page 52
Internal clearance .....	Page 64
Adapter sleeves .....	Page 592
Withdrawal sleeves .....	Page 592

### ● Design

Self-aligning Ball Bearings are particularly suitable for applications where misalignment occurs from errors in mounting or from shaft deflection.

For applications where the bearing load (particularly axial load) carrying capacity is insufficient, spherical roller bearings, which have the same self-aligning property, should be used instead.

### ● Cage

Bearings are fitted with pressed steel cage or polyamide cage.

The suffix G of bearing number on the packing surface indicate polyamide cage.

### ● Attention

- (1) Maximum permissible misalignment angle  $\theta$  is about  $2.5^\circ$  in the 11 and 22 series, and about  $3^\circ$  in the 13 and 23 series under general service conditions. Care must be taken to provide sufficient clearance between the bearing and surrounding structure when bearing is operating in the full misaligned condition.
- (2) Misaligned bearings will have a tendency to become noisy as speed increases. Due to noise-level constraints, the practical maximum misalignment may be considerably less than the maximum misalignment.
- (3) The dimension tables show the width of the ball assembly as dimension B1 for larger bore sizes of Self-aligning Ball Bearings where width of the ball assembly extends beyond the ring width envelope.
- (4) It is difficult to correctly measure the running clearance of bearings with tapered bore after mounting. Mounting of this type of bearing with tapered bores requires some experience and technique.
- (5) The bearings with polyamide cage should be used at less than  $120^\circ\text{C}$  operating temperature.

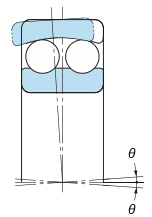

● Mounting bearings with tapered bore

Mounting bearings with a tapered bore requires some experience and technique. Bearings with tapered bore are always mounted with an interference fit on the shaft.

To measure the amount of interference fit on the shaft, the axial displacement of the inner ring or

the reduction of radial internal clearance due to the interference fit can be used. Generally, the measurement of reduction in radial internal clearance is a more reliable method than measurement of the axial displacement of the inner ring.

Table 1. Mounting self-aligning ball bearings with tapered bore

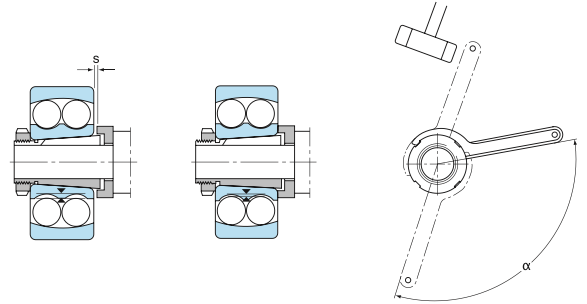

Bearing Bore Diameter d (mm)	Tightening Angle α (degree)	Axial displacement s (mm)				Mean residual clearance after mounting bearings with initial clearance	
		Bearings series				Normal (μm)	C3 (μm)
		12K	13K	22K	23K		
20	70	0.22	0.23	—	—	10	20
25	70	0.22	0.23	0.22	0.23	10	20
30	70	0.22	0.23	0.22	0.23	10	20
35	70	0.30	0.30	0.30	0.30	10	20
40	70	0.30	0.30	0.30	0.30	10	20
45	70	0.31	0.34	0.31	0.33	15	25
50	70	0.31	0.34	0.31	0.33	15	25
55	90	0.40	0.41	0.39	0.40	15	30
60	90	0.40	0.41	0.39	0.40	15	30
65	90	0.40	0.41	0.39	0.40	15	30
75	120	0.45	0.47	0.43	0.46	20	40
80	120	0.45	0.47	0.43	0.46	20	40
85	120	0.58	0.60	0.54	0.59	20	40
90	120	0.58	0.60	0.54	0.59	20	40
95	120	0.58	0.60	0.54	0.59	20	40
100	120	0.58	0.60	0.54	0.59	20	40
105	120	0.67	—	0.66	—	25	55
110	120	0.67	0.70	0.66	0.69	25	55
120	120	0.67	—	—	—	25	55

**Self-aligning Ball Bearings**

Bore Diameter: 10~40mm

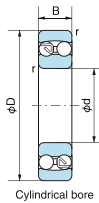

Cylindrical bore

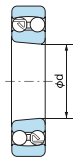

Tapered bore (Taper: 1/12)

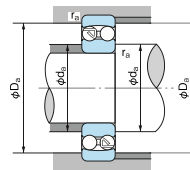

Dynamic equivalent radial load  
 $F_r = XFr + YFa$

$\frac{F_a}{F_r} \leq e$		$\frac{F_a}{F_r} > e$	
X	Y	X	Y
1	$Y_1$	0.65	$Y_2$

Static equivalent radial load  
 $P_0 = Fr + Y_0 Fa$

Values of e,  $Y_1$ ,  $Y_2$  and  $Y_0$  from table.

1N=0.102kgf

Boundary dimensions (mm)					Bearing No.		Basic dynamic load rating $C_r$ (N)	Basic static load rating $C_0r$ (N)	Limiting speed (min <sup>-1</sup> )		Axial load factor			Constant e	Abutment and fillet dimensions (mm)			Mass (kg) (Reference) Cylindrical bore	Bearing No.
d	D	B	$B_1$	r (min)	Cylindrical bore	Tapered bore			Grease lubrication	Oil lubrication	$Y_1$	$Y_2$	$Y_0$		$d_a$ (min)	$D_a$ (max)	$r_a$ (max)		
10	30	9	—	0.6	1200	—	5500	1200	23000	28000	1.92	2.97	2.01	0.33	14	26	0.6	0.034	1200
	30	14	—	0.6	2200	—	7400	1600	23000	29000	1.07	1.65	1.12	0.59	14	26	0.6	0.047	2200
12	32	10	—	0.6	1201	—	5600	1250	21000	26000	1.89	2.93	1.98	0.33	16	28	0.6	0.040	1201
	32	14	—	0.6	2201	—	7650	1750	21000	26000	1.18	1.83	1.24	0.53	16	28	0.6	0.053	2201
	37	12	—	1	1301	—	9400	2150	18000	22000	1.77	2.74	1.86	0.36	17	32	1.0	0.067	1301
	37	17	—	1	2301	—	9700	2300	16000	22000	1.17	1.81	1.23	0.54	17	32	1.0	0.095	2301
15	35	11	—	0.6	1202	—	7450	1750	18000	22000	1.90	2.95	2.00	0.33	19	31	0.6	0.049	1202
	35	14	—	0.6	2202	—	7700	1850	18000	22000	1.27	1.97	1.33	0.50	19	31	0.6	0.060	2202
	42	13	—	1	1302	—	9550	2300	16000	20000	1.86	2.88	1.95	0.34	20	37	1.0	0.094	1302
	42	17	—	1	2302	—	12100	2900	14000	20000	1.27	1.96	1.33	0.50	20	37	1.0	0.114	2302
17	40	12	—	0.6	1203	—	7900	2000	16000	20000	2.03	3.14	2.12	0.31	21	36	0.6	0.073	1203
	40	16	—	0.6	2203	—	9800	2400	16000	20000	1.27	1.96	1.33	0.50	21	36	0.6	0.088	2203
	47	14	—	1	1303	—	12500	3200	14000	17000	1.92	2.97	2.01	0.33	22	42	1.0	0.130	1303
	47	19	—	1	2303	—	14500	3600	13000	18000	1.28	1.98	1.34	0.49	22	42	1.0	0.158	2303
20	47	14	—	1	1204	1204K	9900	2600	14000	17000	2.16	3.35	2.27	0.29	25	42	1.0	0.120	1204
	47	18	—	1	2204	2204K	12600	3300	14000	17000	1.31	2.02	1.37	0.48	25	42	1.0	0.140	2204
	52	15	—	1.1	1304	1304K	12400	3300	13000	15000	2.12	3.28	2.22	0.30	26.5	45.5	1.0	0.163	1304
	52	21	—	1.1	2304	2304K	18000	4700	11000	15000	1.29	2.00	1.35	0.49	26.5	45.5	1.0	0.209	2304
25	52	15	—	1	1205	1205K	12100	3300	12000	14000	2.28	3.52	2.39	0.28	30	47	1.0	0.141	1205
	52	18	—	1	2205	2205K	12600	3500	12000	15000	1.58	2.45	1.66	0.40	30	47	1.0	0.163	2205
	62	17	—	1.1	1305	1305K	18000	5000	9900	12000	2.31	3.57	2.42	0.27	31.5	55.5	1.0	0.257	1305
	62	24	—	1.1	2305	2305K	24400	6600	9400	13000	1.36	2.10	1.42	0.46	31.5	55.5	1.0	0.335	2305
30	62	16	—	1	1206	1206K	15600	4650	9900	12000	2.55	3.94	2.67	0.25	35	57	1.0	0.220	1206
	62	20	—	1	2206	2206K	15600	4650	10000	12000	1.79	2.77	1.87	0.35	35	57	1.0	0.260	2206
	72	19	—	1.1	1306	1306K	21300	6300	8700	11000	2.40	3.72	2.52	0.26	36.5	65.5	1.0	0.387	1306
	72	27	—	1.1	2306	2306K	31400	8750	8000	11000	1.44	2.23	1.51	0.44	36.5	65.5	1.0	0.500	2306
35	72	17	—	1.1	1207	1207K	15800	5100	8500	10000	2.71	4.20	2.84	0.23	41.5	65.5	1.0	0.323	1207
	72	23	—	1.1	2207	2207K	21600	6600	8500	10000	1.71	2.65	1.79	0.37	41.5	65.5	1.0	0.403	2207
	80	21	—	1.5	1307	1307K	25100	7850	7600	9300	2.48	3.84	2.60	0.25	43	72	1.5	0.510	1307
	80	31	—	1.5	2307	2307K	39400	11300	7100	9800	1.39	2.15	1.46	0.45	43	72	1.5	0.675	2307
40	80	18	—	1.1	1208	1208K	19200	6500	7500	9200	2.83	4.38	2.97	0.22	46.5	73.5	1.0	0.417	1208
	80	23	—	1.1	2208	2208K	22400	7400	7600	9300	1.92	2.96	2.01	0.33	46.5	73.5	1.0	0.505	2208
	90	23	—	1.5	1308	1308K	29500	9700	6900	8400	2.57	3.98	2.69	0.25	48	82	1.5	0.715	1308
	90	33	—	1.5	2308	2308K	44900	13500	6200	8600	1.47	2.27	1.54	0.43	48	82	1.5	0.925	2308

Remarks: 1. Suffix K means with a tapered bore (1/12)  
 2. Dimension  $B_1$  is the width of the ball assembly extends beyond the ring width dimension.

**Self-aligning Ball Bearings**

Bore Diameter: 45~80mm

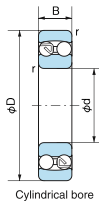

Cylindrical bore

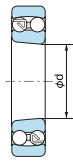

Tapered bore (Taper: 1/12)

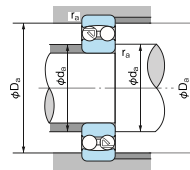

Dynamic equivalent radial load  
 $F_r = XFr + YFa$

$\frac{F_a}{F_r} \leq e$		$\frac{F_a}{F_r} > e$	
X	Y	X	Y
1	Y <sub>1</sub>	0.65	Y <sub>2</sub>

Static equivalent radial load  
 $P_0 = Fr + Y_0 Fa$

Values of e, Y<sub>1</sub>, Y<sub>2</sub> and Y<sub>0</sub> from table.

1N=0.102kgf

Boundary dimensions (mm)					Bearing No.		Basic dynamic load rating Cr (N)	Basic static load rating Cor (N)	Limiting speed (min <sup>-1</sup> )	Axial load factor			Constant e	Abutment and fillet dimensions (mm)			Mass (kg) (Reference Cylindrical bore)	Bearing No.	
d	D	B	B <sub>1</sub>	r (min)	Cylindrical bore	Tapered bore				Grease lubrication	Oil lubrication	Y <sub>1</sub>		Y <sub>2</sub>	Y <sub>0</sub>	d <sub>a</sub> (min)			D <sub>a</sub> (max)
45	85	19	—	1.1	1209	1209K	21800	7350	7000	8500	2.94	4.56	3.09	0.21	51.5	78.5	1.0	0.465	1209
	85	23	—	1.1	2209	2209K	23300	8150	7000	8500	2.09	3.23	2.19	0.30	51.5	78.5	1.0	0.545	2209
	100	25	—	1.5	1309	1309K	38100	12700	6100	7500	2.56	3.95	2.68	0.25	53	92	1.5	0.957	1309
	100	36	—	1.5	2309	2309K	54400	16700	5600	7700	1.51	2.33	1.58	0.42	53	92	1.5	1.23	2309
50	90	20	—	1.1	1210	1210K	22700	8100	6500	7900	3.07	4.76	3.22	0.21	56.5	83.5	1.0	0.525	1210
	90	23	—	1.1	2210	2210K	23300	8500	6500	7900	2.33	3.61	2.45	0.27	56.5	83.5	1.0	0.590	2210
	110	27	—	2	1310	1310K	43400	14100	5600	6800	2.70	4.17	2.83	0.23	59	101	2.0	1.21	1310
	110	40	—	2	2310	2310K	64600	20300	5100	7000	1.56	2.41	1.63	0.40	59	101	2.0	1.64	2310
55	100	21	—	1.5	1211	1211K	26800	10000	5800	7100	3.19	4.94	3.34	0.20	63	92	1.5	0.705	1211
	100	25	—	1.5	2211	2211K	26800	10000	5800	7100	2.35	3.64	2.47	0.27	63	92	1.5	0.810	2211
	120	29	—	2	1311	1311K	51300	17900	5000	6200	2.70	4.18	2.83	0.23	64	111	2.0	1.58	1311
	120	43	—	2	2311	2311K	75300	24000	4600	6400	1.53	2.37	1.60	0.41	64	111	2.0	2.10	2311
60	110	22	—	1.5	1212	1212K	30200	11500	5200	6400	3.37	5.22	3.53	0.19	68	102	1.5	0.900	1212
	110	28	—	1.5	2212	2212K	34100	12600	5300	6500	2.26	3.49	2.36	0.28	68	102	1.5	1.09	2212
	130	31	—	2.1	1312	1312K	57200	20800	4500	5500	2.91	4.50	3.05	0.22	71	119	2.0	1.96	1312
	130	46	—	2.1	2312	2312K	87200	28300	4200	5800	1.62	2.51	1.70	0.39	71	119	2.0	2.60	2312
65	120	23	—	1.5	1213	1213K	31000	12500	4800	5800	3.67	5.68	3.84	0.17	73	112	1.5	1.15	1213
	120	31	—	1.5	2213	2213K	43500	16400	4900	5900	2.24	3.47	2.35	0.28	73	112	1.5	1.46	2213
	140	33	—	2.1	1313	1313K	61700	22900	4300	5200	2.73	4.23	2.86	0.23	76	129	2.0	2.45	1313
	140	48	—	2.1	2313	2313K	95800	32500	3800	5300	1.66	2.58	1.74	0.38	76	129	2.0	3.23	2313
70	125	24	—	1.5	1214	—	34600	13800	4600	5700	3.48	5.38	3.64	0.18	78	117	1.5	1.26	1214
	125	31	—	1.5	2214	—	43900	17100	4600	5600	2.42	3.74	2.53	0.26	78	117	1.5	1.52	2214
	150	35	—	2.1	1314	—	74000	27700	4000	4900	2.84	4.40	2.98	0.22	81	139	2.0	2.99	1314
	150	51	—	2.1	2314	—	89600	31700	3600	4900	1.82	2.82	1.91	0.35	81	139	2.0	4.23	2314
75	130	25	—	1.5	1215	1215K	38800	15700	4300	5300	3.60	5.58	3.77	0.17	83	122	1.5	1.36	1215
	130	31	—	1.5	2215	2215K	44200	17800	4300	5300	2.49	3.85	2.61	0.25	83	122	1.5	1.62	2215
	160	37	—	2.1	1315	1315K	78900	29900	4000	4900	2.80	4.33	2.93	0.23	86	149	2.0	3.56	1315
	160	55	—	2.1	2315	2315K	103000	36800	3400	4600	1.86	2.88	1.95	0.34	86	149	2.0	5.13	2315
80	140	26	—	2	1216	1216K	39800	17000	4000	4900	3.90	6.03	4.08	0.16	89	131	2.0	1.67	1216
	140	33	—	2	2216	2216K	49000	19900	4100	5000	2.42	3.75	2.54	0.26	89	131	2.0	2.01	2216
	170	39	—	2.1	1316	1316K	88100	33100	3500	4300	2.90	4.49	3.04	0.22	91	159	2.0	4.18	1316
	170	58	—	2.1	2316	2316K	129000	45700	3100	4300	1.87	2.90	1.96	0.34	91	159	2.0	6.10	2316

Remarks: 1. Suffix K means with a tapered bore (1/12)  
 2. Dimension B<sub>1</sub> is the width of the ball assembly extends beyond the ring width dimension.

**Self-aligning Ball Bearings**

Bore Diameter: 85~110mm

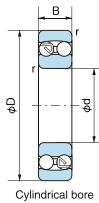

Cylindrical bore

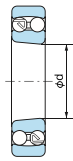

Tapered bore (Taper: 1/12)

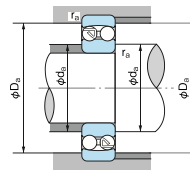

Dynamic equivalent radial load  
 $F_r = XFr + YFa$

$\frac{F_a}{F_r} \leq e$		$\frac{F_a}{F_r} > e$	
X	Y	X	Y
1	Y <sub>1</sub>	0.65	Y <sub>2</sub>

Static equivalent radial load  
 $P_0 = Fr + Y_0 Fa$

Values of e, Y<sub>1</sub>, Y<sub>2</sub> and Y<sub>0</sub> from table.

1N=0.102kgf

Boundary dimensions (mm)					Bearing No.		Basic dynamic load rating Cr (N)	Basic static load rating Cor (N)	Limiting speed (min <sup>-1</sup> )		Axial load factor			Constant e	Abutment and fillet dimensions (mm)			Mass (kg) (Reference) Cylindrical bore	Bearing No.
d	D	B	B <sub>1</sub>	r (min)	Cylindrical bore	Tapered bore			Grease lubrication	Oil lubrication	Y <sub>1</sub>	Y <sub>2</sub>	Y <sub>0</sub>		d <sub>a</sub> (min)	D <sub>a</sub> (max)	r <sub>a</sub> (max)		
85	150	28	—	2	1217	1217K	49200	20800	3800	4600	3.61	5.59	3.78	0.17	94	141	2	2.07	1217
	150	36	—	2	2217	2217K	58300	23600	3800	4600	2.49	3.85	2.61	0.25	94	141	2	2.52	2217
	180	41	—	3	1317	1317K	97300	37800	3300	4000	2.93	4.53	3.07	0.22	98	167	2.5	4.98	1317
	180	60	—	3	2317	2317K	141000	51500	3000	4100	1.82	2.82	1.91	0.35	98	167	2.5	7.05	2317
90	160	30	—	2	1218	1218K	56800	23400	3500	4300	3.69	5.70	3.86	0.17	99	151	2	2.52	1218
	160	40	—	2	2218	2218K	67700	27200	3500	4300	2.39	3.71	2.51	0.26	99	151	2	3.40	2218
	190	43	—	3	1318	1318K	116000	44400	3100	3800	2.81	4.35	2.94	0.22	103	177	2.5	5.80	1318
	190	64	—	3	2318	2318K	153000	57900	2800	3900	1.84	2.85	1.93	0.34	103	177	2.5	8.44	2318
95	170	32	—	2.1	1219	1219K	57000	24300	3300	4000	3.63	5.62	3.80	0.17	106	159	2	3.10	1219
	170	43	—	2.1	2219	2219K	82700	34300	3300	4000	2.43	3.76	2.55	0.26	106	159	2	4.10	2219
	200	45	48.2	3	1319	1319K	132000	50800	2900	3600	2.73	4.23	2.86	0.23	108	187	2.5	6.69	1319
	200	67	—	3	2319	2319K	166000	64800	2700	3700	1.82	2.82	1.91	0.35	108	187	2.5	9.79	2319
100	180	34	—	2.1	1220	1220K	69000	29700	3100	3800	3.62	5.60	3.79	0.17	111	169	2	3.70	1220
	180	46	—	2.1	2220	2220K	80900	34000	3100	3800	2.57	3.98	2.70	0.24	111	169	2	4.98	2220
	215	47	52	3	1320	1320K	143000	57300	2800	3400	2.66	4.11	2.78	0.24	113	202	2.5	8.30	1320
	215	73	—	3	2320	2320K	183000	73400	2400	3400	1.84	2.85	1.93	0.34	113	202	2.5	12.4	2320
105	190	36	—	2.1	1221	—	77000	34000	2900	3600	3.56	5.51	3.73	0.18	116	179	2	4.37	1221
	190	50	—	2.1	2221	—	94900	40100	3000	3600	2.43	3.76	2.55	0.26	116	179	2	6.07	2221
	225	49	54	3	1321	—	149000	60200	2600	3200	2.73	4.22	2.86	0.23	118	212	2.5	10.0	1321
	225	77	—	3	2321	—	187000	78000	2300	3200	1.75	2.71	1.83	0.36	118	212	2.5	14.3	2321
110	200	38	—	2.1	1222	1222K	80200	35200	2800	3400	3.64	5.63	3.81	0.17	121	189	2	5.15	1222
	200	53	—	2.1	2222	2222K	120000	48900	2800	3400	2.41	3.73	2.53	0.26	121	189	2	7.10	2222
	240	50	55.2	3	1322	1322K	150000	63200	2400	3000	2.82	4.37	2.96	0.22	123	227	2.5	11.8	1322
	240	80	—	3	2322	2322K	200000	85700	2200	3000	1.82	2.82	1.91	0.35	123	227	2.5	17.3	2322

Remarks: 1. Suffix K means with a tapered bore (1/12)  
 2. Dimension B1 is the width of the ball assembly extends beyond the ring width dimension.