

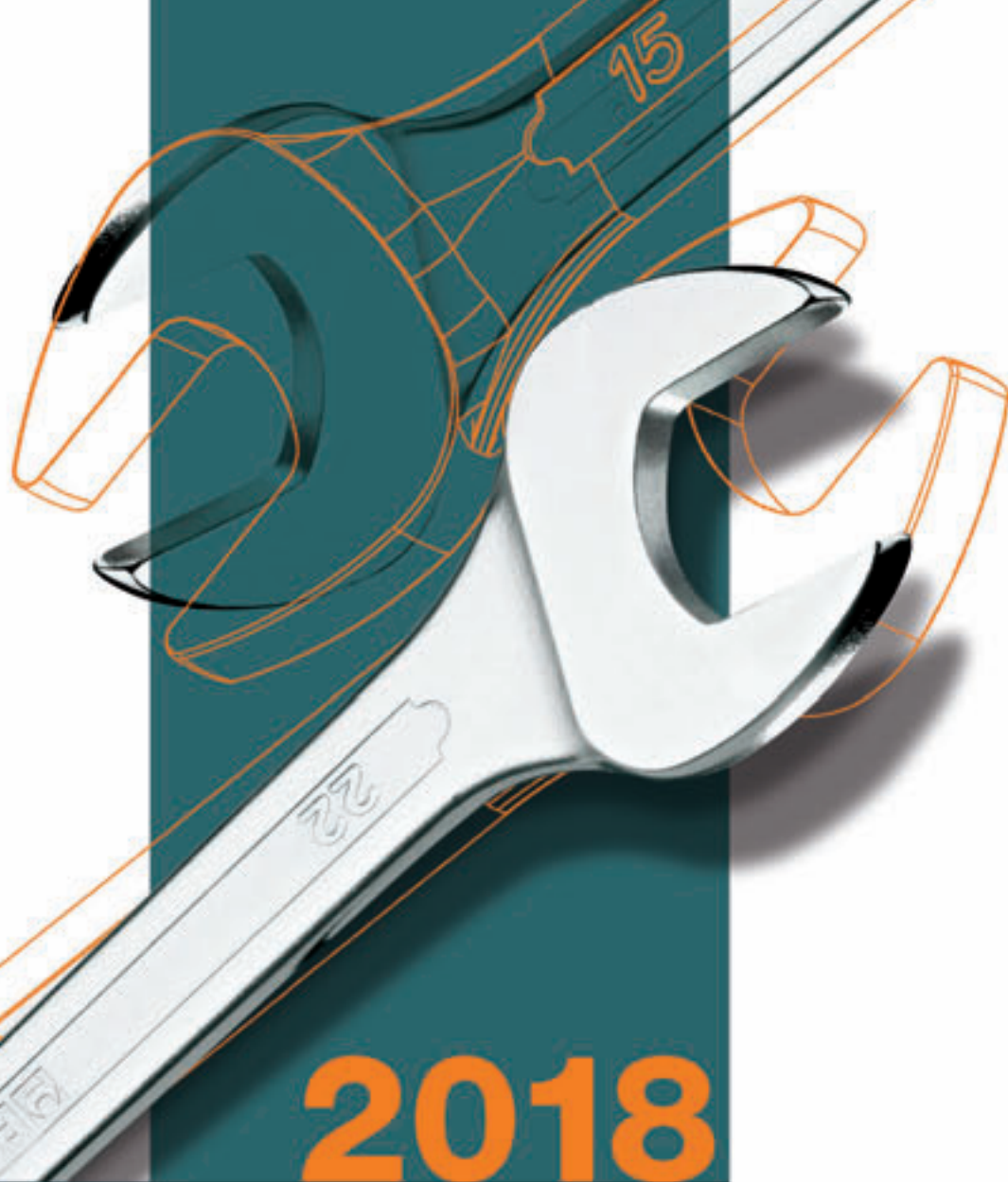

Beta

EN



2018

General Programme

WWW.BETA-TOOLS.COM

1923 - Alessandro Ciceri founded "Alessandro Ciceri & Figli", to manufacture iron and steel casts.

1939 - The trademark Beta was registered and the Company became involved mainly in manufacturing professional tools.

1960 - Beta Utensili employed two hundred people, exported their products and stood out as an up-and-coming manufacturer of professional tools.

1969 - The revolutionary orange sheet metal "Tank" trolley was developed; from that moment orange would result in a unique style for the trademark Beta.

1971 - Beta Utensili entered the motor racing world, with a view to testing and developing their products.

1975 - The Company scored their first Formula 1 victory with the orange **March-Beta Utensili** driven by Vittorio Brambilla, who won the Austrian Grand Prix in Zeltweg, in the pouring rain.

1980 - Beta Utensili further penetrated the main European markets, progressively establishing branches in France, Britain, Holland, Spain and Poland.

1995 - It took the Company no more than 8 months to have their Quality System certified in accordance with the **ISO 9001 standards**.

2000 - The launch of the new Beta Utensili catalogue testified to ongoing growth. The range of available products was doubled, and the over 10,000 coded items were divided into 20 product families.

2002 - Beta Utensili's range was further expanded, being supplemented with safety footwear as well as with work and free-time wear, namely the "Beta Work" range.

2009 - Beta further expanded their markets, establishing Beta China.

2012 - Beta Brazil was founded.

2016 - Beta introduces a new modular workshop equipment combination system.

2018 - Ongoing growth has translated into the current product range - distributed worldwide -, which exceeds 12,000 coded items, designed to satisfy the most demanding professionals' requirements.



1939 Forging department



1950 Galvanising department



1955 Shearing department



1960 Shipping warehouse



1969 Tank trolley



1975 Chrome finishing



1974 Vittorio Brambilla

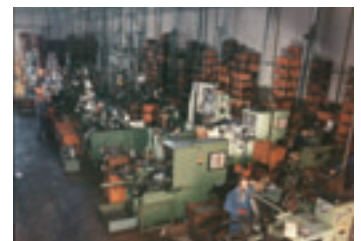

1980 Engineering department



1981 New assortments



2017 Simone Corsi

BETA UTENSILI S.p.A. - 20845 Sovico (MB)
Via A.Volta, 18 - Tel. 039.2077.1 - Telefax 039.2010742
www.beta-tools.com

Robur Wire rope accessories: 67039 Sulmona (AQ)
Zona industriale - C.da S. Nicola - Tel. 0864.2504.1 - Telefax 0864.253132
www.roburitaly.com - info@roburitaly.com

1939



1950



1960



1970



1980



3 PRODUCTION UNITS

Sovico (Monza Brianza)



- **More than 500** staff
- **100.000** square metres, of which **32.000** under cover
- **Over 10 million** pieces/year

Castiglione d'Adda (Lodi)



Sulmona (L'Aquila)



Ergonomics, finish and design serving reliability

For Beta, design does not just mean appearance but above all excellent performance. The study and design of a tool are aimed at achieving safety, strength and easy use. This is why tool design is based on functional needs: functionality leads to appearance, and design becomes the end result of a detailed study of materials and finishes. With this aim in mind, Beta constantly renews the design of its products, reviewing their parts and materials.



Innovation and quality: guidelines for the development of all new Beta projects.





Since 1995 our production processes have complied with the ISO 9001 Quality System standards

Beta quality, our most concrete proof

At Beta, quality has a simple, concrete meaning: "that which fully satisfies the needs and expectations of the professional users who rely on our products as an irreplaceable working instrument". Tools are not only designed and manufactured correctly to fulfil a need, but they must guarantee repeat performances consistently over time.

At Beta, quality goes beyond a merely attentive industrial and sales policy, to permeate every company division, driving us all to achieve increasingly ambitious goals in terms of customer satisfaction. Beta has built its history on this very concept.

The quality of Beta tools is a synergy of age-old techniques and new technologies.



Over 12,000 items

The dynamism of the Company has, over the years, helped it to effectively update its product range to promptly respond to the challenges of the global market.

Today the Beta Utensili range comprises over 12,000 items divided into 22 product families, making it one of the most qualified names in the tool market.

Beta produces tools for professional mechanics, from industrial maintenance to car repairs, and for all those whose hobbies are much more than a simple pastime.

22

families

Each professional need finds an effective solution

Applications



Automotive



Energy



Industry



Oil & Gas



Aeronautics



An “easy” and complete website where you can find our updated catalogues, latest news, promotions and all our technical product information (manuals, spare parts and demo videos, which can also be found on YouTube)



A specific app of all the Beta catalogues for Ipad and Android.



Autopromotec 2017

Beta supplies different store display solutions to offer customers a “turnkey” service.



www.beta-tools.com

Present in over **100 countries** worldwide

Beta's far-reaching distribution network serves professional users across the world.



7 Subsidiaries

Beta **Brasil**



Beta **Benelux**



Beta **China**



Beta **France**



Beta **Iberia**



Beta **Polska**



Beta **UK**



**Quick,
prompt and complete
deliveries**



12.000
coded items
and over **20.000**
loading units



15,000 m²
surface area



RSCSS



304+320



CONTAINERS AND ASSORTMENTS



251+303



321+397

WRENCHES



16+22



27+30



91+95

SOCKETS AND ACCESSORIES



58+63



70+91

TORQUE WRENCHES AND MULTIPLIERS



49+50



50+57

SCREWDRIVERS, MALE-END WRENCHES AND BITS



22+27



63+70



94+95



109+124

PLIERS AND NIPPERS



97+102



106+107



152

HAMMERS AND CHISELS



☐ 15-16



☐ 120+124



☐ 140

DRILLING AND THREADING TOOLS

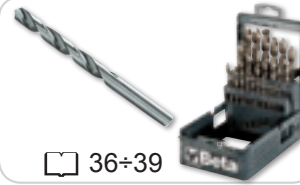

☐ 36+39



☐ 39+40



☐ 41+47



☐ 47+49

PULLERS



☐ 124+125



☐ 125+129

MEASURING AND MARKING TOOLS

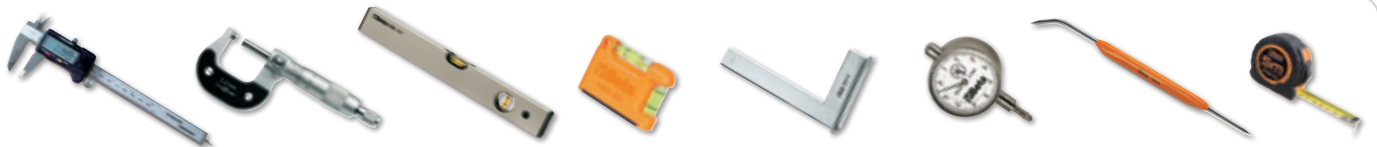

☐ 134+141

CUTTING AND GENERAL MAINTENANCE TOOLS



☐ 173



☐ 101+105



☐ 119



☐ 191



☐ 129



☐ 140+150

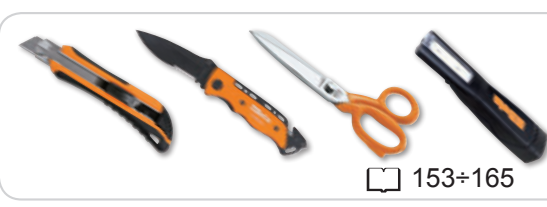

☐ 153+165



PLUMBING TOOLS

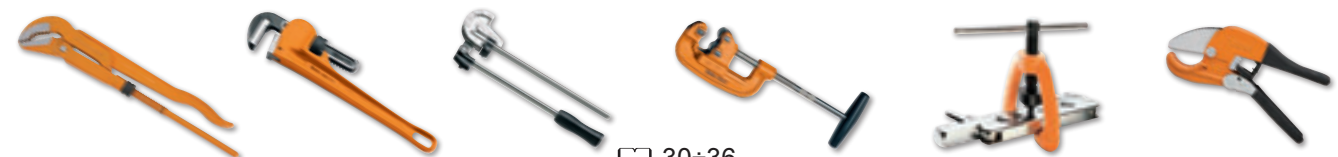

☐ 30+36

ELECTRONICS AND MICROMECHANICS



☐ 95÷97



☐ 108-109



☐ 111÷114



☐ 155-156

ELECTROTECHNICS



☐ 104÷106



☐ 112



☐ 130÷134



☐ 151-152

1000V INSULATED TOOLS



☐ 220÷223

STAINLESS STEEL



☐ 224÷226

SPARKPROOF TOOLS

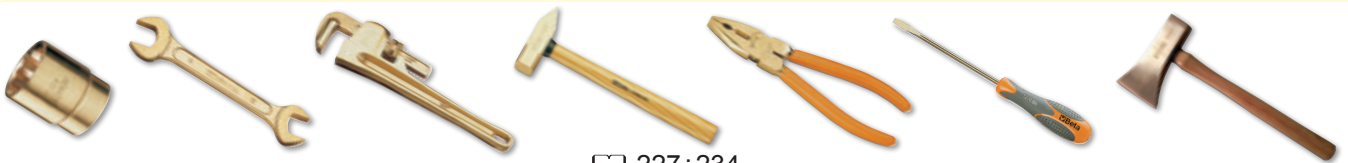

☐ 227÷234

VEHICLE REPAIR



☐ 166÷219

PNEUMATIC TOOLS AND ACCESSORIES



☐ 235+250

ROBUR WIRE ROPE ACCESSORIES



☐ 462+493

SAFETY FOOTWEAR (AND TECHNICAL SOCKS)



☐ 425+447

WORKWEAR



☐ 448+461

DISPLAY UNITS FOR SALES POINTS

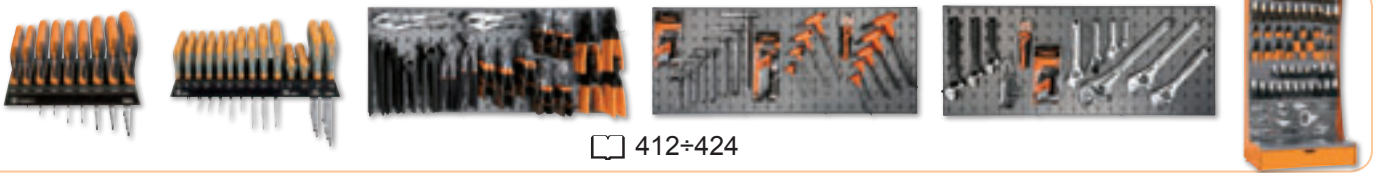

☐ 412+424

BLISTER PACK RANGE

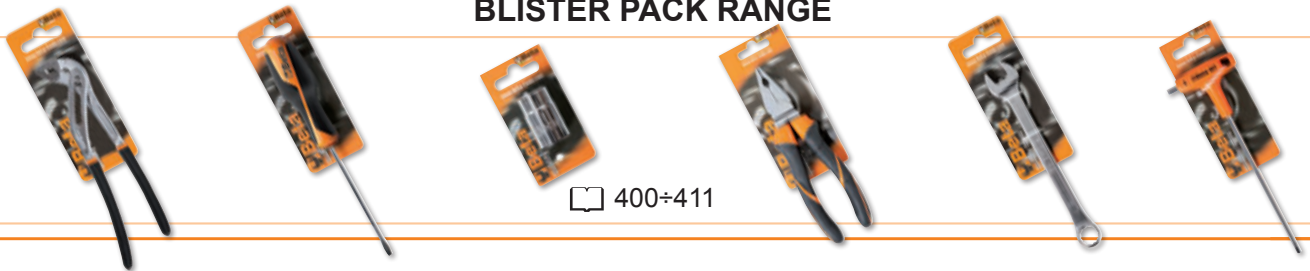

☐ 400+411

BETA COLLECTION



☐ 494+503

item number

42AS

combination wrenches

tool profile



in blister pack



★ item available on request

• main size

◊ hexagon drive

size

n.° of tools per box

n.° of tools per set

type of packaging

set content

Size	L mm	Code	Quantity
1/4x1/4	95	000420106	2
9/32X9/32	106	000420107	2
5/16x5/16	116	000420108	2
3/8x3/8	137	000420110	2
7/16x7/16	148	000420111	2
1/2x1/2	169	000420113	2
9/16x9/16	180	000420114	2
19/32X19/32	191	000420115	2
5/8x5/8	201	000420116	2
11/16x11/16	212	000420117	2
3/4x3/4	233	000420119	2
13/16x13/16	254	000420121	2
7/8x7/8	264	000420122	2
15/16x15/16	285	000420124	2

new item 2018



code number

42AS/13 1/4-5/16-3/8-7/16-1/2-9/16-5/8 11/16-3/4-13/16-7/8-15/16-1	1	000420163
42AS/17 1/4-9/32-5/16-3/8-7/16-1/2 9/16-19/32-5/8-11/16-3/4 13/16-7/8-15/16-1-1.1/16-1.1/8	232,50	1 000420168

Most used symbols

Example

Sets		
B	= in plastic wallet	42/B9
BV	= empty wallet	42/BV9
C	= in case	900/C11
D	= in hanging pack	1293/D6
S	= in box	42/S17
SP	= with display	42/SP5
SPV	= empty display	42/SPV7
SC	= with compact support	96/SC9
SCV	= compact support, empty	96/SCV

Assortments

AS	= with tools in inches	5915VU/AS
E	= Electronics/Electrotechnics	5980ET/A
I	= Plumbing	5980ID
MT	= Earth-moving	5902MT
U	= Universal	5915VU3
SBK	= Motorcycle Repairs	5940SBK
VG	= Automotive	5904VG/5T
VI	= Industry	5902VI

Sockets

A	= hexagon profile	910A
B	= bi-hex profile	910B
ES	= grooved profile	920ES
FTX	= for TORX® screws	910FTX

Most used symbols

Example

PT	= for 5-star head screws	910PT
X	= reversible ratchet in cases	920A/C12X

Screwdrivers and bits

LP	= for slotted head screws	920LP
PE	= for hexagon screws	920PE
PH	= for cross head PHILLIPS® screws	920PH
PZ	= for cross head POZIDRIV® - SUPADRIV® screws	1299PZ
RTX	= for TAMPER RESISTANT TORX® screws	1298RTX
SP	= for SPANNER screws	861SP
TRW	= for TRI-WING® screws	861TRW
TQS	= for TORQ-SET® screws	861TQS
TX	= for TORX® head screws	920TX
XZN	= for XZN® screws	920XZN

Miscellaneous

AS	= sizes in inches	42AS
BA	= spark-proof tools	42BA
BM	= bi-material handle	1150BM
C	= empty metal container	C25
INOX	= tools made of stainless steel	42 INOX
L	= long series	952L
MQ	= 1000V insulated tools	1150MQ
MP	= bright finish	42MP
R	= spare part	338R

The pictures are given by way of example.

Beta Utensili reserve the right to update and enhance their product range without notice.



Beta RECOMMENDS
using the tools correctly and complying
with personal protection standards.



30

drift punches



Ø mm	L mm	
2	125	10 000300020
3	125	10 000300030
4	150	10 000300040
5	150	10 000300050
6	150	10 000300060

31

pin punches



Ø mm	L mm	L1 mm	
2	110	22	10 000310002
3	128	35	10 000310003
4	146	45	10 000310004
5	164	55	10 000310005
6	182	65	5 000310006
8	200	80	5 000310008
10	220	95	5 000310010



31/B6	2-3-4-5-6-8 mm	1 000310020
42/BV6		1 000420051
31/SP6	2-3-4-5-6-8 mm	1 000310030
31/SPV		1 000310031

31BM

pin punches with handles



Ø mm	L mm	L1 mm	
2	168	42	2 000310402
3	180	52	2 000310403
4	191	62	2 000310404
5	200	72	2 000310405
6	221	82	2 000310406
8	235	94	2 000310408



31BM/D6	2-3-4-5-6-8 mm	1 000310420
---------	----------------	-------------

31L

pin punches, long series



Ø mm	L mm	L1 mm	
4	175	80	5 000310104
5	175	80	5 000310105
6	175	80	5 000310106

31SE

punches for spring pins



Ø mm	D mm	L mm	L1 mm	
4	2,4	175	80	5 000310204
5	3,0	175	80	5 000310205
6	3,6	175	80	5 000310206



31/B6-LSE	31L: 4-5-6 mm	1 000310320
31SE:	4-5-6 mm	
55/BV6		1 000550151

32

centre punches



Ø mm	L mm	L1 mm	
3	100	44	10 000320100
4	125	52	10 000320125
5	150	62	10 000320150

32AU

automatic centre punches



Ø mm	L mm	L1 mm	
3	150	23	2 000320160

32AUR

spare tip for automatic centre punch



Ø mm	
3	5 000320170

34

flat chisels



L mm	A mm	L1 mm	
125	14,5	45	5 000340001
150	17,0	58	5 000340002
175	21,5	68	5 000340003

35

flat chisels, ribbed type



L mm	A mm	
100	14,5	5 000350001
125	17,0	5 000350002
150	20,5	5 000350003
200	23,0	5 000350004
250	28,5	2 000350005
300	34,0	2 000350006

35PM

flat chisels, ribbed type with hand guards



L mm	A mm	
200	23,0	2 000350014
250	28,5	2 000350015
300	34,0	2 000350016

35PMR

spare hand guards



L mm	
200	1 000350024
250	1 000350025
300	1 000350026

36

cape chisels



L mm	A mm	L1 mm		
125	4	44	5	000360001
150	6	53	5	000360002

37

cape chisels, ribbed type

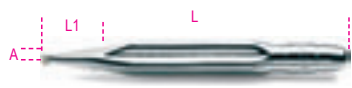

L mm	A mm	L1 mm		
150	6	45	5	000370001
200	8	55	3	000370002

37PM

cape chisel, ribbed type
with hand guard



L mm	A mm		
200	8	2	000370012

37PMR

spare hand guard



L mm		
200	1	000370022



38/B6			
30: 2-3 mm			
32: 4 mm			
34: 125-150 mm			
36: 150 mm			
42/BV6	1	000420051	
38/SP6	1	000380009	
30: 2-3 mm			
32: 4 mm			
34: 125-150 mm			
36: 150 mm			
38/SPV	1	000380019	

42

combination wrenches,
open and offset ring ends



DIN 3113 UNI-ISO 7738

mm	L mm		
5,5x5,5	95	5	000420005
6x6	95	5	000420006
7x7	105	5	000420007
8x8	116	5	000420008
9x9	127	5	000420009
10x10	137	5	000420010
11x11	148	5	000420011
12x12	158	5	000420012
13x13	169	5	000420013
14x14	180	5	000420014
15x15	190	5	000420015
16x16	201	5	000420016
17x17	212	5	000420017
18x18	222	5	000420018
19x19	233	5	000420019
20x20	243	3	000420020
21x21	254	3	000420021
22x22	264	3	000420022
23x23	275	3	000420023
24x24	285	3	000420024
25x25	296	2	000420025
26x26	307	2	000420026
27x27	317	2	000420027
28x28	328	2	000420028
29x29	338	2	000420029
30x30	349	2	000420030
32x32	370	2	000420032
34x34	391	1	000420034
35x35	412	1	000420035
36x36	412	1	000420036
38x38	433	1	000420038
41x41	465	1	000420041



42/B9	1	000420064
6-7-8-10-11-13-14-17-19 mm		
42/BV9	1	000420056



42/S14	1	000420067
6-7-8-10-11-12-13-14- -15-16-17-19-22-24 mm		
42/S15	1	000420066
6-7-8-10-11-12-13-14- 17-19-22-24-27-30-32 mm		
42/S17	1	000420065
6-7-8-9-10-11-12-13-14-15- 16-17-18-19-20-21-22 mm		
42/S17X	1	000420068
6-7-8-10-11-12-13-14- 15-16-17-19-21-22- 24-27-30 mm		
42/S26	1	000420070
6-7-8-9-10-11-12-13-14- 15-16-17-18-19-20-21- 22-23-24-25-26-27-28- 29-30-32 mm		

42/SC9I-E

set of 9 combination wrenches, open and
offset ring ends, with compact support



42/SC9I	1	000420087
8-10-11-12-13-14-15-17-19 mm		
42/SCV9I	1	000420103
42/SC9E	1	000420088
8-10-11-12-13-16-17-18-19 mm		
42/SCV9E	1	000420104



42/SP25	1	000420085
6-7-8-9-10-11-12-13-14- 15-16-17-18-19-20-21- 22-23-24-25-26-27-28- 30-32 mm		
42/SPV2	1	000420090



42/SP15	1	000420078
6-7-8-9-10-11-12-13-14-15- 16-17-19-22-24 mm		
42/SPV7	1	000420097
42: 8-10-11-13-14-17-19 mm		
55: 6x7-8x9-10x11-12x13- 14x15-16x17-18x19 mm		
42/SPV11	1	000420100
42MP: 8-9-10-11-12-13- 14-15-16-17-19 mm		
142-142SN: 8-9-10-11-12-13- 14-15-16-17-19 mm		
42/SPV15	1	000420102
42: 6-7-8-9-10-11-12-13-14- 15-16-17-19-22-24 mm		

42AS

combination wrenches,
open and offset ring ends



mm	L mm		
1/4x1/4	95	2	000420106
9/32x9/32	106	2	000420107
5/16x5/16	116	2	000420108
3/8x3/8	137	2	000420110
7/16x7/16	148	2	000420111
1/2x1/2	169	2	000420113
9/16x9/16	180	2	000420114
19/32x19/32	191	2	000420115
5/8x5/8	201	2	000420116
11/16x11/16	212	2	000420117
3/4x3/4	233	2	000420119
13/16x13/16	254	2	000420121
7/8x7/8	264	2	000420122
15/16x15/16	285	2	000420124
1x1	296	2	000420125
1.1/16x1.1/16	317	2	000420127
1.1/8x1.1/8	338	2	000420129
1.1/4x1.1/4	370	2	000420132
1.5/16x1.5/16	391	1	000420133
1.3/8x1.3/8	412	1	000420135
1.7/16x1.7/16	412	1	000420136
1.1/2x1.1/2	433	1	000420138



mm	L mm		
42AS/B9		1	000420155
1/4-5/16-3/8-7/16-1/2			
9/16-5/8-11/16-3/4			



mm	L mm		
42AS/13		1	000420163
1/4-5/16-3/8-7/16-1/2-9/16-5/8			
11/16-3/4-13/16-7/8-15/16-1			
42AS/16		1	000420166
1/4-5/16-3/8-7/16-1/2-9/16-5/8			
11/16-3/4-13/16-7/8-15/16-1-1.1/16-1.1/8-1.1/4			
42AS/17		1	000420168
1/4-9/32-5/16-3/8-7/16-1/2-9/16-19/32-5/8-11/16-3/4-13/16-7/8-15/16-1-1.1/16-1.1/8			

42MP

combination wrenches, open and offset
ring ends, bright chrome-plated



DIN 3113 UNI-ISO 7738

mm	L mm		
6x6	95	5	000420606
7x7	105	5	000420607
8x8	116	5	000420608
9x9	127	5	000420609
10x10	137	5	000420610
11x11	148	5	000420611
12x12	158	5	000420612
13x13	169	5	000420613
14x14	180	5	000420614
15x15	190	5	000420615
16x16	201	5	000420616
17x17	212	5	000420617
18x18	222	5	000420618
19x19	233	5	000420619
20x20	243	3	000420620
21x21	254	3	000420621
22x22	264	3	000420622
24x24	285	3	000420624
27x27	317	3	000420627
30x30	349	3	000420630
32x32	370	3	000420632



mm	L mm		
42MP/B9		1	000420651
6-7-8-10-11-13-14-17-19 mm			
42/BV9		1	000420056

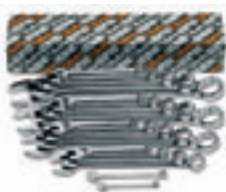

mm	L mm		
42MP/S17		1	000420652
6-7-8-9-10-11-12-13-14-15-16-17-18-19-20-21-22 mm			
42MP/S21		1	000420653
6-7-8-9-10-11-12-13-14-15-16-17-18-19-20-21-22-24-27-30-32 mm			

42LMP

combination wrenches, open and offset
ring ends, long series, bright chrome-plated



mm	L mm		
8x8	148	2	000420508
9x9	167	2	000420509
10x10	172	2	000420510
11x11	186	2	000420511
12x12	197	2	000420512
13x13	207	2	000420513
14x14	223	2	000420514
15x15	233	2	000420515

mm	L mm		
16x16	243	2	000420516
17x17	261	2	000420517
18x18	270	2	000420518
19x19	280	2	000420519
21x21	301	2	000420521
22x22	318	2	000420522
24x24	338	2	000420524
27x27	376	2	000420527
30x30	394	2	000420530
32x32	435	2	000420532



mm	L mm		
42LMP/S14		1	000420551
8-9-10-11-12-13-14-15-16-17-18-19-21-22 mm			
42LMP/S18		1	000420552
8-9-10-11-12-13-14-15-16-17-18-19-21-22-24-27-30-32 mm			

45

combination wrenches,
open and offset ring ends, heavy series



DIN 3113 UNI-ISO 7738

mm	L mm		
46x46	520	1	000450046
50x50	560	1	000450050
55x55	610	1	000450055
60x60	660	1	000450060
65x65	710	1	000450065
70x70	760	1	000450070
75x75	810	1	000450075
80x80	860	1	000450080

52

single open end wrenches



UNI 6733 DIN 3114

mm	L mm		
10	119	5	000520010
11	119	5	000520011
12	119	5	000520012
13	145	5	000520013
14	145	5	000520014
15	145	5	000520015
16	159	5	000520016
17	159	5	000520017
18	159	5	000520018
19	175	5	000520019
20	175	5	000520020
21	175	5	000520021
22	196	2	000520022
23	196	2	000520023
24	196	2	000520024
25	215	2	000520025
26	215	2	000520026
27	215	2	000520027
28	240	2	000520028
30	240	2	000520030
32	270	2	000520032

Beta
INOX
STAINLESS STEEL

224

mm	L mm		
34	270	1	000520034
35	295	1	000520035
36	295	1	000520036
38	295	1	000520038
40	335	1	000520040
41	335	1	000520041
42	335	1	000520042
45	370	1	000520045
46	370	1	000520046
48	370	1	000520048
50	415	1	000520050
52	415	1	000520052
55	415	1	000520055
60	490	1	000520060
65	490	1	000520065
70	490	1	000520070

53

single open end wrenches DIN 894



mm	L mm		
36	317	1	000530036
38	320	1	000530038
41	342	1	000530041
46	396	1	000530046
50	412	1	000530050
55	457	1	000530055
60	492	1	000530060
65	528	1	000530065
70	572	1	000530070
75	608	1	000530075
80	645	1	000530080
85	690	1	000530085
90	690	1	000530090
95	847	1	000530095
100	847	1	000530100
105	1000	1	000530105
110	1000	1	000530110
115	1000	1	000530115
120	1000	1	000530120
125	1000	1	000530125
130	1000	1	000530130
135	1000	1	000530135

55

double open end wrenches



UNI-ISO 10102 DIN 3110

mm	L mm		
4x5	101	5	000550003
5x5,5	101	5	000550006
5,5x7	120	5	000550009
• 6x7	120	5	000550012
7x8	140	5	000550018
• 8x9	140	5	000550021
8x10	140	5	000550024
• 10x11	155	5	000550030
10x12	155	5	000550033
10x13	170	5	000550035
• 12x13	170	5	000550042
12x14	170	5	000550045
13x14	185	5	000550047
13x17	189	5	000550051
• 14x15	185	5	000550054
14x17	189	5	000550057
• 16x17	202	5	000550060
17x19	220	2	000550063
• 18x19	220	2	000550066
19x22	236	2	000550069
• 20x22	236	2	000550075
• 21x23	245	2	000550078
22x24	245	2	000550081

mm	L mm		
• 24x26	262	2	000550087
24x27	262	2	000550090
• 25x28	272	2	000550096
• 27x29	284	2	000550099
27x30	284	2	000550102
27x32	297	2	000550105
• 30x32	297	2	000550108
32x36	325	1	000550114
34x36	325	1	000550117
35x38	375	1	000550120
36x41	375	1	000550123
41x46	425	1	000550129
46x50	475	1	000550132
50x55	500	1	000550135
55x60	500	1	000550138



55/B8	6x7-8x9-10x11-12x13 14x15-16x17-18x19 20x22 mm	1	000550158
55/BV8		1	000550159
55/B12	6x7-8x9-10x11-12x13 14x15-16x17-18x19 20x22-21x23-24x26 25x28-30x32 mm	1	000550162
55/BV12		1	000550163



55/S8	6x7-8x9-10x11-12x13 14x15-16x17-18x19 20x22 mm	1	000550174
55/S12	6x7-8x9-10x11-12x13 14x15-16x17-18x19 20x22-21x23-24x26 25x28-30x32 mm	1	000550178
55/S12X	6x7-8x9-10x11-12x13 14x15-16x17-18x19 20x22-21x23-24x27 25x28-30x32 mm	1	000550179
55/S13	6x7-8x9-10x11-12x13 14x15-16x17-18x19 20x22-21x23-24x26 25x28-27x29-30x32 mm	1	000550182



55/SP7



55/SP13

55/SP7	6x7-8x9-10x11-12x13 14x15-16x17-18x19 mm	1	000550167
42/SPV7	42: 8-10-11-13-14-17-19 mm 55: 6x7-8x9-10x11-12x13 14x15-16x17-18x19 mm	1	000420097
55/SP13	6x7-8x9-10x11-12x13 14x15-16x17-18x19 20x22-21x23-24x26 25x28-27x29-30x32 mm	1	000550186
55/SPV		1	000550190

55AS

double open end wrenches



mm	L mm		
1/4x9/32	120	2	000550203
1/4x5/16	120	2	000550206
5/16x11/32	140	2	000550209
5/16x3/8	140	2	000550212
3/8x7/16	155	2	000550215
7/16x1/2	170	2	000550218
1/2x9/16	170	2	000550221
9/16x5/8	185	2	000550224
19/32x11/16	189	2	000550227
5/8x11/16	202	2	000550230
5/8x3/4	202	2	000550233
11/16x13/16	220	2	000550242
3/4x7/8	236	2	000550245
25/32x13/16	236	2	000550244
7/8x15/16	245	2	000550251
15/16x1	262	1	000550257
1x1.1/8	272	1	000550259
1.1/16x1.1/4	284	1	000550267
1.1/8x1.5/16	297	1	000550266
1.5/16x1.1/2	325	1	000550269
1.3/8x1.1/2	375	1	000550272
1.7/16x1.5/8	375	1	000550275



55AS/5	5/16x11/32-3/8x7/16 1/2x9/16-5/8x11/16 3/4x7/8	1	000550290
55AS/8	1/4x9/32-5/16x11/32-3/8x7/16- 1/2x9/16-9/16x5/8-5/8x11/16- 11/16x13/16-3/4x7/8	1	000550296
55AS/12	1/4x9/32-5/16x11/32-3/8x7/16-1 /2x9/16-9/16x5/8-5/8x11/16- 11/16x13/16-25/32x13/16-3/4x7/8- 15/16x1-1x1.1/8-1.1/16x1.1/4	1	000550298

55MP

double open end wrenches,
bright chrome-plated



UNI-ISO 10102 DIN 3110

mm	L mm		
6x7	120	2	000550603
8x9	140	2	000550606
10x11	155	2	000550609
12x13	170	2	000550612
14x15	185	2	000550615
16x17	202	2	000550618
18x19	220	2	000550621
20x22	236	2	000550624
21x23	245	2	000550627
24x26	262	1	000550630
25x28	272	1	000550633
27x29	284	1	000550636
30x32	297	1	000550639

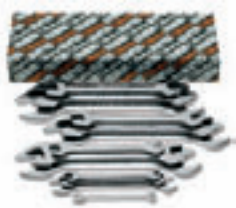

55MP/S8	1	000550650
6x7-8x9-10x11-12x13		
14x15-16x17-18x19		
20x22 mm		
55MP/S13	1	000550651
6x7-8x9-10x11-12x13		
14x15-16x17-18x19		
20x22-21x23-24x26		
25x28-27x29-30x32 mm		
55MP/S12	1	000550653
6x7-8x9-10x11-12x13-14x15-		
16x17-18x19-20x22-21x23-24x26-		
25x28-30x32 mm		

58

open end slogging wrenches



DIN 133

mm	L mm		
24	177	1	000580024
27	180	1	000580027
30	190	1	000580030
32	190	1	000580032
34	200	1	000580034
36	215	1	000580036
41	235	1	000580041
46	255	1	000580046
50	275	1	000580050
55	300	1	000580055
60	320	1	000580060
65	342	1	000580065
70	375	1	000580070
75	375	1	000580075
80	408	1	000580080
85	408	1	000580085
90	445	1	000580090
95	445	1	000580095
100	485	1	000580100
105	485	1	000580105

mm	L mm		
110	510	1	000580110
115	510	1	000580115
120	545	1	000580120
125	545	1	000580125
130	575	1	000580130
135	575	1	000580135
*140	575	1	000580140
*145	640	1	000580145
*150	640	1	000580150
*155	640	1	000580155
*160	640	1	000580160
*165	715	1	000580165
*170	715	1	000580170
*175	715	1	000580175
*180	715	1	000580180
*185	715	1	000580185
*190	800	1	000580190
*195	800	1	000580195
*200	800	1	000580200
*210	800	1	000580210
*220	800	1	000580220
*230	800	1	000580230

73

small double open end wrenches



UNI 6737

mm	L mm		
4x4	78	5	000730040
4,5x4,5	78	5	000730045
5x5	78	5	000730050
5,5x5,5	86	5	000730055
6x6	86	5	000730060
7x7	86	5	000730070
8x8	97	5	000730080
9x9	97	5	000730090
10x10	108	5	000730100
11x11	108	5	000730110
12x12	124	5	000730120
13x13	124	5	000730130
14x14	124	5	000730140



73/B13	1	000730200
4-4,5-5-5,5-6-7-8-9		
10-11-12-13-14 mm		
73/BV	1	000730201



73/S13	1	000730210
4-4,5-5-5,5-6-7-8-9		
10-11-12-13-14 mm		



78

ring slogging wrenches



DIN 7444

mm	L mm		
24	162	1	000780024
27	180	1	000780027
30	190	1	000780030
32	190	1	000780032
36	205	1	000780036
41	225	1	000780041
46	235	1	000780046
50	250	1	000780050
55	265	1	000780055
60	275	1	000780060
65	295	1	000780065
70	325	1	000780070
75	325	1	000780075
80	350	1	000780080
85	350	1	000780085
90	390	1	000780090
95	390	1	000780095
100	420	1	000780100
105	420	1	000780105
110	450	1	000780110
115	450	1	000780115
120	490	1	000780120
125	480	1	000780125
130	520	1	000780130
135	520	1	000780135
*140	520	1	000780140
*145	580	1	000780145
*150	580	1	000780150
*155	580	1	000780155
*160	650	1	000780160
*165	650	1	000780165
*170	650	1	000780170
*175	650	1	000780175
*180	650	1	000780180
*185	695	1	000780185
*190	695	1	000780190
*195	695	1	000780195
*200	695	1	000780200
*210	740	1	000780210
*215	740	1	000780215
*220	740	1	000780220
*230	740	1	000780230

78AS

ring slogging wrenches



"	L mm		
*1.1/16	180	1	000780327
*1.1/8	190	1	000780329
*1.3/16	190	1	000780330
*1.1/4	197	1	000780332
*1.5/16	197	1	000780333
*1.3/8	223	1	000780335
*1.7/16	223	1	000780336
*1.1/2	223	1	000780338
*1.5/8	223	1	000780341
*1.11/16	225	1	000780343
*1.13/16	240	1	000780346
*1.7/8	250	1	000780348
*2	250	1	000780350
*2.1/16	250	1	000780352
*2.3/16	275	1	000780355
*2.3/8	270	1	000780360
*2.9/16	302	1	000780365
*2.3/4	350	1	000780370
*2.15/16	350	1	000780375
*3.1/8	354	1	000780380

80

double swivel end socket wrenches



mm	L mm	QTY	Part No.
6x7	170	3	000800006
8x9	176	3	000800008
8x10	179	3	000800009
10x11	182	3	000800010
12x13	228	3	000800012
14x15	232	3	000800014
13x17	231	3	000800015
16x17	234	2	000800016
18x19	285	2	000800018
19x22	287	2	000800019
20x22	289	2	000800020
21x23	289	2	000800021
24x27	405	2	000800024
30x32	413	2	000800030

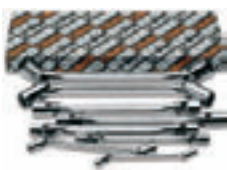

80/S8	1	000800051
6x7-8x9-10x11-12x13-14x15 16x17-18x19-20x22 mm		
80/S11	1	000800056
6x7-8x9-10x11-12x13 14x15-16x17-18x19-20x22 21x23-24x27-30x32 mm		

83

half-moon ring wrenches



ISO 3318

mm	L mm	QTY	Part No.
8x10	126	3	000830008
10x12	137	3	000830010
11x13	138	3	000830011
14x17	183	3	000830014
15x17	184	2	000830015
16x18	196	2	000830016
19x22	231	2	000830019



83/S3	1	000830081
11x13-14x17-19x22 mm		
83/S5	1	000830085
10x12-11x13-15x17 16x18-19x22 mm		

83AS

half-moon ring wrenches



mm	L mm	QTY	Part No.
7/16x1/2	138	2	000830111
9/16x5/8	183	2	000830114
3/4x7/8	230	2	000830119



83AS/3	1	000830181
7/16x1/2-9/16x5/8 3/4x7/8		

88

double ended flat ring wrenches, extra-long series



mm	L mm	QTY	Part No.
8x10	235	2	000880008
12x14	330	2	000880012
13x15	330	2	000880013
16x18	405	2	000880016
17x19	405	2	000880017
21x23	435	2	000880021
22x24	435	2	000880022



88/S7	1	000880107
8x10-12x14-13x15-16x18- 17x19-21x23-22x24 mm		

90

double ended deep offset ring wrenches



DIN 838 ISO 10104

mm	L mm	QTY	Part No.
6x7	165	5	000900006
8x9	180	5	000900012
8x10	180	5	000900015
10x11	195	5	000900018
10x12	195	5	000900021
11x13	215	5	000900024
12x13	215	5	000900027
12x14	215	5	000900030
14x15	230	5	000900033
14x17	250	5	000900036
16x17	250	5	000900039
17x19	265	5	000900042
18x19	265	5	000900045
19x22	285	3	000900048
20x22	285	3	000900051
21x23	305	2	000900057
22x24	305	2	000900060
24x26	325	2	000900063
24x27	325	2	000900067
25x28	340	2	000900070
27x29	355	2	000900073
27x30	355	2	000900076
27x32	375	2	000900078
30x32	375	2	000900080
32x36	395	1	000900088
34x36	415	1	000900089
35x38	415	1	000900091
36x41	435	1	000900094
41x46	460	1	000900097
46x50	500	1	000900100



90/B8	1	000900154
6x7-8x9-10x11-12x13 14x15-16x17-18x19 20x22 mm		
90/BV8	1	000900155

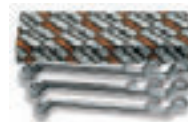

90/S8	1	000900162
6x7-8x9-10x11-12x13 14x15-16x17-18x19 20x22 mm		
90/S12	1	000900166
6x7-8x9-10x11-12x13 14x15-16x17-18x19 20x22-21x23-24x26 25x28-30x32 mm		
90/S12X	1	000900167
6x7-8x9-10x11-12x13 14x15-16x17-18x19 20x22-21x23-24x27 25x28-30x32 mm		
90/S13	1	000900170
6x7-8x9-10x11-12x13 14x15-16x17-18x19 20x22-21x23-24x26 25x28-27x29-30x32 mm		



90/SP13
6x7-8x9-10x11-12x13
14x15-16x17-18x19
20x22-21x23-24x26
25x28-27x29-30x32 mm
55/SPV

1 000900174
1 000550190

90AS

double ended deep offset ring wrenches



mm	L mm	
1/4x5/16	165	2 000900203
5/16x11/32	180	2 000900206
5/16x3/8	180	2 000900209
3/8x7/16	195	2 000900212
7/16x1/2	215	2 000900215
1/2x9/16	230	2 000900218
9/16x5/8	230	2 000900221
19/32x11/16	250	2 000900222
5/8x11/16	250	2 000900224
5/8x3/4	265	2 000900227
11/16x3/4	265	1 000900230
11/16x13/16	265	1 000900233
3/4x25/32	265	1 000900235
3/4x7/8	285	1 000900237
13/16x7/8	285	1 000900240
7/8x15/16	305	1 000900243
15/16x1	325	1 000900252
1.1/16x1.1/4	375	1 000900258
1.1/8x1.5/16	375	1 000900261

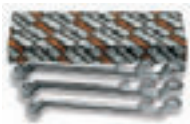

90AS/8
1/4x5/16-5/16x11/32
3/8x7/16-1/2x9/16
5/8x11/16-11/16x3/4
13/16x7/8-15/16x1

1 000900298

90AS/10
1/4x5/16-5/16x11/32
3/8x7/16-1/2x9/16
5/8x11/16-11/16x3/4
13/16x7/8-15/16x1
1.1/16x1.1/4-1.1/8x1.5/16

1 000900300

91 heavy duty offset ring wrenches



mm	Ø mm	
24	38	1 000910024
27	41	1 000910027
30	48	1 000910030
32	49	1 000910032
36	54	1 000910036
41	62	1 000910041
46	69	1 000910046
50	76	1 000910050
55	81	1 000910055
60	90	1 000910060
65	98	1 000910065
70	105	1 000910070
75	110	1 000910075
80	125	1 000910080
85	125	1 000910085
90	140	1 000910090
95	140	1 000910095
100	143	1 000910100
105	146	1 000910105

92 tubes for item 91



	L mm	91 mm	Ø mm	
92/1	460	24÷30	19	1 000920010
92/2	610	32÷41	22	1 000920020
92/3	760	46÷55	25	1 000920030
92/4	860	60÷105	30	1 000920040

93 double-ended offset ring wrench for scaffolding bolts



mm	L mm	
21x22	310	3 000930021

93C ratcheting double-ended offset ring wrenches for scaffolding bolts



mm	L mm	
17x19	315	1 000930117
19x22	315	1 000930119
19x24	315	1 000930120
21x22	315	1 000930121
36x38	315	1 000930136

94 flare nut open ring wrenches



DIN 3118

mm	L mm	
8x10	140	2 000940008
9x11	153	2 000940009
10x11	153	2 000940010
11x13	175	2 000940011
12x14	175	2 000940012
13x15	175	2 000940013
14x15	175	2 000940014
14x17	195	2 000940015
17x19	212	2 000940017
19x22	228	2 000940019
22x24	242	2 000940022
24x27	260	2 000940024
30x32	300	2 000940030
36x41	320	1 000940036



94/S6
8x10-10x11-11x13-12x14
17x19-19x22 mm

1 000940050

94/S10
8x10-9x11-10x11-11x13
12x14-17x19-19x22
22x24-24x27-30x32 mm

1 000940052

95 double ended flat ring wrenches



DIN 837 ISO 10103

mm	L mm	
6x7	120	3 000950161
8x9	135	3 000950162
10x11	150	3 000950163
12x13	165	3 000950164
14x15	185	3 000950165
16x17	210	3 000950166
17x19	225	3 000950167
18x19	225	2 000950168
20x22	240	2 000950169
21x23	255	2 000950170
24x26	270	2 000950171
25x28	285	2 000950172
27x29	315	2 000950173
30x32	335	2 000950174



95/S8
6x7-8x9-10x11-12x13
14x15-16x17-18x19
20x22 mm

1 000950177

95/S13
6x7-8x9-10x11-12x13
14x15-16x17-18x19
20x22-21x23-24x26
25x28-27x29-30x32 mm

1 000950179

Beta

95FTX

double-ended straight wrenches,
for Torx® head screws



	L mm		
E6xE8	115	2	000950306
E10xE12	143	2	000950310
E14xE18	177	2	000950314
E20xE24	224	2	000950320



95FTX/S4		1	000950325
E6xE8-E10xE12			
E14xE18-E20xE24			

96

offset hexagon key wrenches
chrome-plated



ISO 2936

mm	L mm	L1 mm		
0,9	35	8	20	000960013
1,3	39	10	20	000960014
1,5	45	15	20	000960015
2	50	17	20	000960020
2,5	57	20	20	000960025
3	64	22	20	000960030
3,5	68	25	20	000960035
4	72	28	20	000960040
4,5	78	30	20	000960045
5	83	32	20	000960050
5,5	88	35	20	000960055
6	94	37	20	000960060
7	99	40	10	000960070
8	105	43	10	000960080
9	111	46	10	000960090
10	119	49	10	000960100
11	126	52	10	000960110
12	134	56	10	000960120
13	142	62	10	000960130
14	151	69	10	000960140
16	165	75	5	000960160
17	174	79	5	000960170
19	196	88	5	000960190
22	216	100	3	000960220
24	242	112	1	000960240
27	271	125	1	000960270
30	309	140	1	000960300
32	341	155	1	000960312
36	385	174	1	000960316



96/ST6		3	000960370
2,5-3-4-5-6-8 mm			



96/BGS7		1	000960367
1,5-2-2,5-3-4-5-6 mm			



96/BG7		1	000960368
2,5-3-4-5-6-8-10 mm			



96/B8		5	000960386
2-2,5-3-4-5-6-8-10 mm			
96/B10		5	000960380
1,5-2-2,5-3-4-5-6-8-10-12 mm			
96N/BV		1	000960651



96/SC9		1	000960374
1,5-2-2,5-3-4-5-6-8-10 mm			
96/SCV		1	000960985



96/SC12		1	000960395
2-2,5-3-3,5-4-4,5-5-6-7-8-9-10 mm			
96/SCV12		1	000960975

 **Beta**

96N

offset hexagon key wrenches,
burnished



ISO 2936

mm	L mm	L1 mm		
0,9	32	10	20	000960409
1,3	44	12	20	000960413
1,5	46	15	20	000960415
2	51	17	20	000960420
2,5	57	20	20	000960425
3	64	22	20	000960430
3,5	68	25	20	000960435
4	72	28	20	000960440
4,5	78	30	20	000960445
5	83	32	20	000960450
6	94	37	20	000960460
7	99	40	10	000960470
8	105	43	10	000960480
9	111	46	10	000960490
10	119	49	10	000960500
11	126	52	10	000960510
12	134	56	10	000960520
13	142	62	10	000960530
14	151	69	10	000960540
16	165	72	5	000960560
17	174	79	5	000960570
19	194	88	5	000960590
22	216	99	1	000960592
24	242	111	1	000960594



96N/ST6		3	000960640
2,5-3-4-5-6-8 mm			



96N/G7		3	000960645
2,5-3-4-5-6-8-10 mm			
96N/G7A		3	000960643
1,5-2-2,5-3-4-5-6 mm			



96N/B10		5	000960650
1,5-2-2,5-3-4-5-6-8-10-12 mm			
96N/BV		1	000960651



96N/SC9
1,5-2-2,5-3-4-5-6-8-10 mm
96N/SCV

1 000960644
1 000960986



96N/SC12
2-2,5-3-3,5-4-4,5-5
6-7-8-9-10 mm
96N/SCV12

1 000960661
1 000960976

96C/AS

offset hexagon key wrenches,
chrome-plated



"	L mm	L1 mm	g		
1/16	46	16	1,01	20	000961702
3/32	53	19	2,70	20	000961706
1/8	60	22	5,33	20	000961710
5/32	67	25	9,33	20	000961714
3/16	74	28	14,87	20	000961716
7/32	81	32	22,00	20	000961718
1/4	89	35	31,40	20	000961720
5/16	103	40	56,16	10	000961724
3/8	117	45	91,31	10	000961728



96C-AS/SC9
1/16-3/32-1/8-5/32-3/16-
7/32-1/4-5/16-3/8

1 000961753

96AS

offset hexagon key wrenches,
burnished



"	L mm	L1 mm		
1/30 (0,035")	44	14	20	000960698
1/20 (0,050")	44	15	20	000960701
1/16	46	16	20	000960702
5/64	50	18	20	000960704
3/32	53	19	20	000960706
7/64	57	21	20	000960708
1/8	60	22	20	000960710
9/64	64	24	20	000960712
5/32	68	25	20	000960714
3/16	75	29	20	000960716
7/32	82	32	20	000960718
1/4	89	35	20	000960720
5/16	103	40	10	000960724
3/8	117	44	10	000960728
7/16	132	49	10	000960730
1/2	149	54	10	000960732
9/16	151	69	2	000960734
5/8	165	72	1	000960736
3/4	194	88	1	000960738



96AS/SC9
1/16-3/32-1/8-5/32-3/16
7/32-1/4-5/16-3/8
96AS/SCV

1 000960743
1 000960744



96AS/T7
3/32-1/8-5/32
3/16-7/32-1/4-5/16

3 000960740



96AS/G7
3/32-1/8-5/32
3/16-1/4-5/16-3/8

3 000960745



96AS/BG7
3/32-1/8-5/32-3/16
1/4-5/16-3/8

1 000960747



96AS/B11
1/20-1/16-5/64-3/32
1/8-5/32-3/16-7/32
1/4-5/16-3/8
96N/BV

1 000960749
1 000960651

96LC

offset hexagon key wrenches,
long series, chrome-plated



ISO 2936

mm	L mm	L1 mm		
2	101	17	20	000960320
2,5	113	20	20	000960321
3	127	22	20	000960322
3,5	138	25	20	000960323
4	142	28	20	000960324
4,5	154	28	20	000960325
5	163	32	20	000960326
6	184	37	20	000960327
7	194	40	10	000960328
8	205	43	10	000960329
9	216	46	10	000960330
10	231	49	10	000960331
12	259	56	10	000960332



96LC/SC8
2-2,5-3-4-5-6-8-10 mm
96LC/SCV

1 000960334
1 000960983



96LC/SC12
2-2,5-3-3,5-4-4,5-5
6-7-8-9-10 mm
96LC/SCV12

1 000960337
1 000960977

96L

offset hexagon key wrenches,
long series, burnished



ISO 2936

mm	L mm	L1 mm		
2	99	15	20	000960820
2,5	110	17	20	000960825
3	124	19	20	000960830
3,5	135	21	20	000960835
4	138	24	20	000960840
4,5	150	25	20	000960845
5	158	27	20	000960850
6	178	31	20	000960860
7	187	33	10	000960870
8	197	35	10	000960880
9	207	37	10	000960890
10	221	39	10	000960900
12	247	44	10	000960920



96L/SC8
2-2,5-3-4-5-6-8-10 mm
96L/SCV



96L/SC12
2-2,5-3-3,5-4-4,5-5-6-7-8-9-10 mm
96L/SCV12

96BPC

ball head offset hexagon key wrenches
chrome-plated

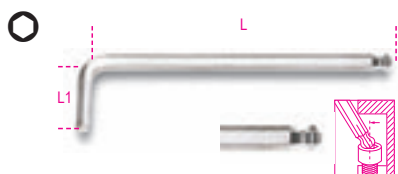

mm	L mm	L1 mm		
1,5	79	13	10	000960340
2	84	15	10	000960341
2,5	89	17	10	000960342
3	99	19	10	000960343
4	108	24	10	000960344
5	126	27	10	000960345
6	148	31	10	000960346
7	157	33	5	000960353
8	168	35	5	000960347
10	187	39	5	000960348
12	220	55	5	000960352



96BPC/SC9
1,5-2-2,5-3-4-5-6-8-10 mm
96BPC/SCV

96BP

ball head offset hexagon key wrenches
burnished

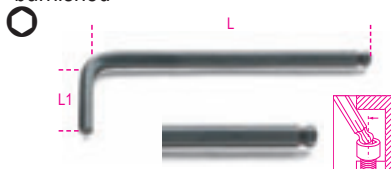

mm	L mm	L1 mm		
1,5	79	13	10	000960960
2	84	15	10	000960961
2,5	89	17	10	000960962
3	99	19	10	000960963
4	108	24	10	000960965
5	126	27	10	000960967
6	148	31	10	000960968
8	168	35	5	000960970
10	187	39	5	000960972
12	220	55	5	000960973



96BP/SC9
1,5-2-2,5-3-4-5-6-8-10 mm
96BP/SCV

96LBP

ball head offset hexagon key wrenches,
extra-long model

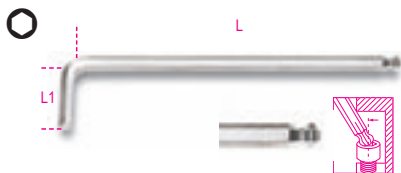

mm	L mm	L1 mm		
1,5	90	15	5	000961340
2	100	17	5	000961341
2,5	112	20	5	000961342
3	127	22	5	000961343
4	144	27	5	000961344
5	163	32	5	000961345
6	184	37	5	000961346
8	204	44	2	000961348
10	230	49	2	000961350



96LBP/SC9
1,5-2-2,5-3-4-5-6-8-10 mm
96LBP/SCV

96BP/AS

ball head offset hexagon wrenches
burnished

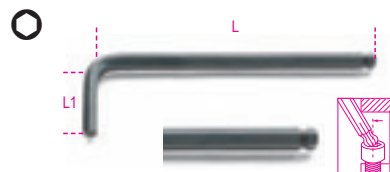

"	L mm	L1 mm		
3/32	89	17	10	000960989
1/8	98	18	10	000960990
5/32	108	24	10	000960991
3/16	126	26	10	000960992
7/32	139	28	10	000960993
1/4	152	31	10	000960994
5/16	168	34	5	000960995
3/8	190	39	5	000960996



96BP-AS/SC9
1/16-3/32-1/8-5/32-3/16
7/32-1/4-5/16-3/8
96BP-AS/SCV



96BP-AS/8
3/32-1/8-5/32-3/16-7/32
1/4-5/16-3/8
96BP-AS/BV

 **Beta**

96BPA

ball head offset hexagon key wrenches, 110°, extra-short side model



mm	L mm	L1 mm		
1,5	71	9	5	000961960
2	86	11	5	000961961
2,5	96	13	5	000961962
3	104	15	5	000961963
4	116	17	5	000961964
5	132	19	5	000961965
6	155	21	5	000961966
8	176	24	2	000961968
10	200	27	2	000961970



96BPA/SC9	1	000961974
1,5-2-2,5-3-4-5-6-8-10 mm		
96BPA/SCV	1	000961988

96T

offset hexagon key wrenches, with high torque handles

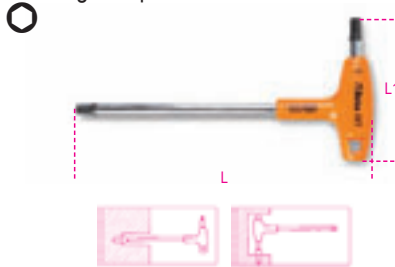

mm	L mm	L1 mm		
2	139	52	5	000960934
2,5	153	55	5	000960935
3	153	55	5	000960936
3,5	179	70	5	000960937
4	179	70	5	000960938
4,5	200	84	5	000960939
5	200	84	5	000960940
6	221	103	5	000960941
7	236	106	3	000960942
8	255	117	3	000960943
10	285	132	3	000960945



96T/S6	1	000960952
2-2,5-3-4-5-6 mm		
96T/S8	1	000960933
2-2,5-3-4-5-6-8-10 mm		
96T/S11	1	000960951
2-2,5-3-3,5-4-4,5-5-6-7-8-10 mm		



96T/SP11	1	000960957
2-2,5-3-3,5-4-4,5-5		
6-7-8-10 mm		
96T/SPV	1	000960958
96T/S11		
97TTX/S11		

96T/AS

offset hexagon key wrenches, with high torque handles

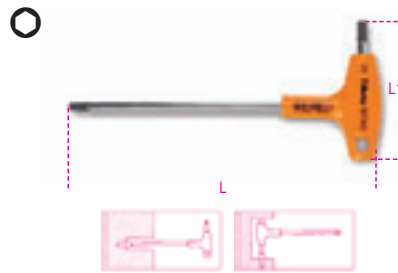

"	L mm	L1 mm		
3/32	153	55	2	000960669
7/64	153	55	2	000960670
1/8	179	70	2	000960671
9/64	179	70	2	000960672
5/32	200	84	2	000960673
3/16	200	84	2	000960674
7/32	221	103	2	000960675
1/4	236	106	2	000960676
5/16	255	117	2	000960678
3/8	285	132	2	000960680

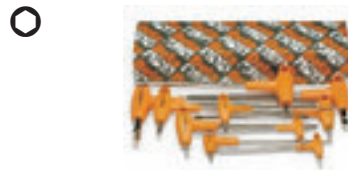

96T/AS8	1	000960682
3/32-7/64-1/8-5/32-3/16-1/4-5/16-3/8		
96T/AS10	1	000960683
3/32-7/64-1/8-9/64-5/32-3/16-7/32-1/4-5/16-3/8		



96TBP

ball head offset hexagon key wrenches with high torque handles



mm	L mm	L1 mm		
2,5	153	55	3	000960685
3	153	55	3	000960686
4	179	70	3	000960687
5	200	84	3	000960688
6	221	103	3	000960689
8	255	117	2	000960690
10	285	132	2	000960692

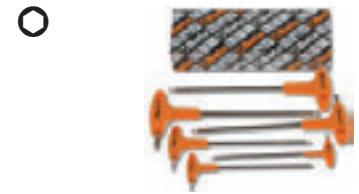

96TBP/S6	1	000960694
2,5-3-4-5-6-8 mm		

97TX

offset key wrenches, for Torx® head screws



mm	L mm	L1 mm		
T6	42	16	5	000970006
T7	48	16	5	000970007
T8	48	16	5	000970008
T9	48	16	5	000970009
T10	51	17	5	000970010
T15	54	18	5	000970015
T20	57	19	5	000970020
T25	60	20	5	000970025
T27	64	21	5	000970027
T30	70	24	5	000970030
T40	76	26	5	000970040
T45	83	29	5	000970045
T50	95	32	5	000970050
T55	108	35	5	000970055
T60	120	38	5	000970060



97TX/ST8	1	000970640
T9-T10-T15-T20-T25-T27-T30-T40		



97TX/G8
T9-T10-T15-T20-T25
T27-T30-T40

1 000970645



97TX/BG8
T9-T10-T15-T20-T25-T27-T30-T40

1 000970368



97TX/SC8
T9-T10-T15-T20-T25
T27-T30-T40

1 000970064

1 000970985



97TX/B13
T6-T7-T8-T9-T10-T15-T20
T25-T27-T30-T40-T45-T50

1 000970650

1 000960651

97BTX

ball head offset key wrenches,
for Torx® head screws

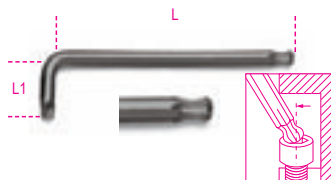

	L mm	L1 mm	
T9	80	16	5 000970109
T10	86	17	5 000970110
T15	90	18	5 000970115
T20	95	19	5 000970120
T25	100	20	5 000970125
T27	105	21	5 000970127
T30	114	24	5 000970130
T40	124	26	5 000970140
T45	133	28	5 000970145
T50	152	32	3 000970150
T55	164	35	3 000970155



97BTX/SC8
T9-T10-T15-T20-T25-T27-T30-T40

1 000970164

1 000970983



97BTX/B8
T9-T10-T15-T20-T25
T27-T30-T40

1 000970159

1 000960651

97BTXL

ball head offset key wrenches, long model,
for Torx® head screws

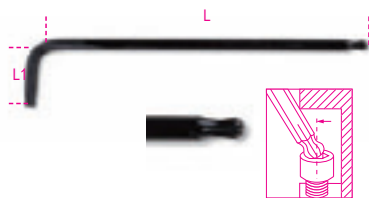

	L mm	L1 mm	
T9	80	15	3 000970309
T10	86	17	3 000970310
T15	100	18	3 000970315
T20	110	19	3 000970320
T25	126	20	3 000970325
T27	140	24	3 000970327
T30	160	28	3 000970330
T40	176	32	3 000970340



97BTXL/SC8
T9-T10-T15-T20-
T25-T27-T30-T40

1 000970364

1 000970982

97RTX

offset key wrenches
for Tamper Resistant Torx® head screws



	L mm	L1 mm	
T9	56	16	5 000970209
T10	62	17	5 000970210
T15	72	17	5 000970215
T20	83	18	5 000970220
T25	90	18	5 000970225
T27	100	20	5 000970227
T30	105	24	5 000970230
T40	112	26	5 000970240



97RTX/SC8
T9-T10-T15-T20-T25
T27-T30-T40

1 000970263

1 000970984



97RTX/B8
T9-T10-T15-T20-T25
T27-T30-T40

1 000970260

1 000960651

97TTX

offset key wrenches with handles
for Torx® head screws



	L mm	L1 mm	
T6	130	52	3 000970706
T7	130	52	3 000970707
T8	139	52	3 000970708
T9	139	52	3 000970709
T10	179	70	3 000970710
T15	179	70	3 000970715
T20	179	70	3 000970720
T25	179	70	3 000970725
T27	200	84	3 000970727
T30	200	84	3 000970730
T40	221	103	3 000970740
T45	236	106	2 000970745
T50	255	117	2 000970750

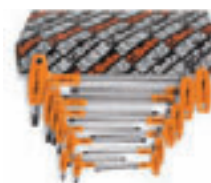

97TTX/S6
T10-T15-T20-T25-T30-T40

1 000970791

97TTX/S8
T8-T10-T15-T20-T25-
T27-T30-T40

1 000970808

97TTX/S11
8-9-10-15-20-25
27-30-40-45-50

1 000970800

97TTX/S13
T6-T7-T8-T9-T10-T15-T20-T25
T27-T30-T40-T45-T50

1 000970813



97TTX/SP11 T8-T9-T10-T15-T20-T25 T27-T30-T40-T45-T50	1	000970840
96T/SPV 96T/S11 97TTX/S11	1	000960958

98XZN

offset key wrenches with XZN® profile



DIN 65253

	L mm	L1 mm		
M5	83	25	5	000980005
M6	89	30	5	000980006
M8	97	32	5	000980008
M10	106	35	5	000980010
M12	116	37	5	000980012
M14	118	45	5	000980014
M16	125	45	5	000980016



98XZN/B5 M5-M6-M8-M10-M12	1	000980650
96N/BV	1	000960651

99

hook wrenches with square noses, for ring nuts UNI/ISO 2982, 2983



UNI 6752

	A mm		
12-14	1,5	3	000990012
16-18-20	1,8	3	000990016
22-25-28	1,8	3	000990022
30-32	2,1	3	000990030
34-36-38	2,4	3	000990034
40-42	2,4	3	000990040
45-50	2,5	3	000990045
52-55-58	2,5	3	000990052
62-65	3,1	3	000990062
68-70-75	3,1	3	000990068
80-85-90	3,8	2	000990080
92-95	4,3	2	000990092
98-100	4,3	2	000990098
105-110-115	4,4	1	000990105
120-125-130	4,9	1	000990120
135-145	6,0	1	000990135
155-165	6,0	1	000990155

99SQ

hook wrenches with square noses for ring nuts



	B mm		
15-35	2,7	2	000990215
35-50	3,5	2	000990235
50-80	4,7	2	000990250
80-120	6,2	2	000990280
120-180	7,8	2	000990290

99ST

hook wrenches with round noses for ring nuts



	Ø mm	B mm		
15-35	3,0	2,5	2	000990315
35-50	4,0	4,5	2	000990335
50-80	5,0	5,0	2	000990350
80-120	6,0	7,0	2	000990380
120-180	8,0	9,0	2	000990390

99 VN/...

spare nose for item 99ST

99ST VN/15	15-35	1	000990295
99ST VN/35	35-50	1	000990296
99ST VN/50	50-80	1	000990297
99ST VN/80	80-120	1	000990298
99ST VN/120	120-180	1	000990299

100

round pin wrench for ring nuts with front holes



	L mm	Ø min-max mm		
4,9-5,9	250	18+100	1	001000001
6,9-7,9				

100/KIT

spare pins for item 100



100/KIT	1	001000010
----------------	---	-----------

111

adjustable wrenches with scales, chrome-plated

- Right-hand rotation of pin
- With mm and inch scale



DIN 3117 ISO 6787

L mm	L "	A max mm		
100	4	15	3	001110010
150	6	24	3	001110015
200	8	28	3	001110020
250	10	34	3	001110025
300	12	35	3	001110030
380	15	45	3	001110038
450	18	54	2	001110045
600	24	62	1	001110060

111N

adjustable wrenches with scales, phosphatized

- Left-hand rotation of pin
- With mm and inch scale



DIN 3117 ISO 6787

L mm	L "	A max mm		
100	4	15	3	001110210
150	6	24	3	001110215
200	8	28	3	001110220
250	10	34	3	001110225
300	12	35	3	001110230
380	15	45	3	001110238
450	18	54	2	001110245

111G

adjustable wrenches with scales chrome-plated

- Right-hand rotation of pin
- Mm and inch scale
- Ergonomic handle



DIN 3117 ISO 6787

L mm	L "	A max mm		
200	8	28	3	001110620
250	10	34	3	001110625
300	12	35	2	001110630



120

ratchet opening single ended bi-hex wrenches

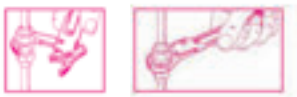

mm	L mm		
10	135	1	001200010
11	135	1	001200011
12	135	1	001200012
13	135	1	001200013
14	135	1	001200014
17	185	1	001200017
19	185	1	001200019
22	230	1	001200022
24	230	1	001200024
27	230	1	001200027
30	320	1	001200030
32	320	1	001200032



120/B6	10-11-13	1	001200050
120/BV	17-19-22 mm	1	001200051

123E1/4

bit holder adaptor, 1/4", for 10 mm ratcheting wrenches

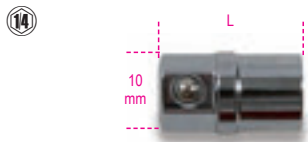

mm	L mm		
10	20,6	1	001230010

123Q1/4

quick release adaptor, 1/4", for 10 mm ratcheting wrenches

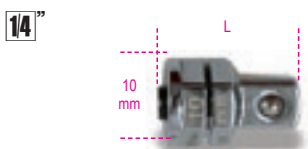

mm	L mm		
10	17,5	1	001230310

123Q3/8

quick release adaptor, 3/8", for 13 mm ratcheting wrenches



mm	L mm		
13	22,5	1	001230313

123Q1/2

quick release adaptor, 1/2", for 19 mm ratcheting wrenches

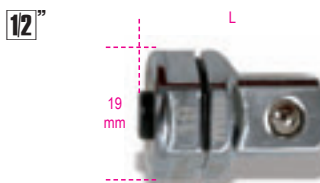

mm	L mm		
19	30,5	1	001230319

123/K4

kit with 4 adapters for ratchet wrenches:

- 1 bit adapter
- 3 quick release adapters



123/K4	1	001230504
--------	---	-----------

142

reversible ratcheting combination wrenches



mm	L mm		
6x6	136	3	001420006
7x7	136	3	001420007
8x8	136	3	001420008
9x9	143	3	001420009
10x10	159	3	001420010
11x11	168	3	001420011
12x12	174	3	001420012
13x13	180	3	001420013
14x14	190	2	001420014
15x15	200	2	001420015
16x16	216	2	001420016
17x17	233	2	001420017
18x18	239	2	001420018
19x19	248	2	001420019
21x21	285	1	001420021
22x22	285	1	001420022
24x24	325	1	001420024
27x27	355	1	001420027
30x30	420	1	001420030
32x32	420	1	001420032
* 36x36	480	1	001420036

* Straight model without inverter



142/B6	8-10-13-14-17-19 mm	1	001420066
142/BV6		1	001420076
142/B9	8-10-11-12-13-14-15-17-19 mm	1	001420069
142/BV9		1	001420079



142/S15	6-7-8-9-10-11-12-13 14-15-16-17-18-19-22 mm	1	001420074
142/S17	6-7-8-10-11-12-13-14-15- 16-17-18-19-21-22-24-27 mm	1	001420068
142/S19	6-7-8-9-10-11-12 13-14-15-16-17-18 19-22-24-27-30-32 mm	1	001420075

142/SC9I-E

set of 9 reversible ratcheting combination wrenches, with compact support



142/SC9I	8-10-11-12-13-14-15-17-19 mm	1	001420087
142/SCV9I		1	001420103
142/SC9E	8-10-11-12-13-16-17-18-19 mm	1	001420088
142/SCV9E		1	001420104

142AS

reversible ratcheting combination wrenches



mm	L mm		
5/16x5/16	136	2	001420308
3/8x3/8	159	2	001420310
7/16x7/16	168	2	001420311
1/2x1/2	180	2	001420313
9/16x9/16	190	2	001420314
5/8x5/8	216	2	001420316
11/16x11/16	233	2	001420317
3/4x3/4	248	2	001420319



142AS /8
5/16-3/8-7/16-1/2
9/16-5/8-11/16-3/4

142C

ratcheting combination wrenches,
straight short series



mm	L mm	
8x8	88	2 001420108
9x9	96	2 001420109
10x10	96	2 001420110
11x11	100	2 001420111
12x12	104	2 001420112
13x13	108	2 001420113
14x14	114	2 001420114
15x15	118	2 001420115
16x16	122	2 001420116
17x17	128	2 001420117
18x18	132	2 001420118
19x19	138	2 001420119



142C/A12
8-9-10-11-12-13-14
15-16-17-18-19 mm

142SN

swivel end ratcheting
combination wrenches



mm	L mm	
7x7	136	2 001420207
8x8	136	2 001420208
9x9	143	2 001420209
10x10	160	2 001420210
11x11	168	2 001420211
12x12	174	2 001420212
13x13	180	2 001420213
14x14	193	2 001420214
15x15	200	2 001420215
16x16	216	2 001420216
17x17	233	2 001420217
18x18	239	2 001420218
19x19	250	2 001420219
22x22	285	1 001420222
24x24	325	1 001420224



142SN/S13
7-8-9-10-11-12-13-14
15-16-17-18-19 mm

186

self-locking wrench with automatic take-up
device
for hexagons, 8 to 32 mm

Ideal for hexagon, Spline, square and Torx® head screws,
including damaged screws.



L mm
260

187

swivelling, openable wrenches



mm	L mm	
8x9	125	1 001870008
10x11	155	1 001870010
12x13	175	1 001870012
14x15	205	1 001870014
16x17	235	1 001870016



187/B5
8x9-10x11-12x13
14x15-16x17 mm

188

ratcheting flat bi-hex ring wrenches
for free alternator pulleys



mm	L mm	
10	240	2 001880010
15	322	2 001880015

192

reversible ratcheting double-ended flat bi-hex
ring wrenches, 4 in 1



mm	L mm	
8x10/12x13	160	1 001920008
16x17/18x19	230	1 001920016



192/S2
8x10/12x13
16x17/18x19 mm

194

reversible ratcheting wrench
for bits



1/4x5/16 L mm
128

195

ratcheting double-ended flat bi-hex ring
wrenches



mm	L mm	
8x10	128	2 001950010
12x13	170	2 001950013
14x15	190	2 001950015
16x18	230	2 001950018
17x19	230	2 001950019



195/B5
8x10-12x13-14x15
16x18-17x19 mm
195/BV5

195AS

ratcheting double-ended flat bi-hex ring
wrenches



mm	L mm	
5/16x3/8	128	2 001950606
7/16x1/2	170	2 001950611
9/16x5/8	190	2 001950614
11/16x3/4	230	2 001950617



195AS/B4	1	001950654
5/16x3/8 - 7/16x1/2 -		
9/16x5/8 - 11/16x3/4		
195FTX/BV4	1	001950520

195P

reversible ratcheting double-ended offset bi-hex wrenches, bent at 15°



mm	L mm		
8x10	128	2	001950210
12x13	170	2	001950213
14x15	190	2	001950215
16x18	230	2	001950218
17x19	230	2	001950219



195P/B5	1	001950266
8x10-12x13-14x15		
16x18-17x19 mm		
195/BV5	1	001950070

310

polywelder for PE, PP, PVC and PVDF pipes and fittings

CE



230V-650 Watt
50 Hz+60Hz
Schuko (CEE 7/7)

mm			
310/1	16÷50	1	003100001
310/2	16÷63	1	003100002

310B

forms for polywelder item 310



mm			
16		1	003100016
20		1	003100020
25		1	003100025
32		1	003100032
40		1	003100040
50		1	003100050
63		1	003100063

310/C4

polywelder with assortment of 3 forms



310/C4	1	003100104
--------	---	-----------

310/1+310B: Ø 20-25-32

410x260x82 mm - 4,8 kg

310/C8

polywelder with assortment of 7 forms



310/C8	1	003100108
--------	---	-----------

310/2+310B: Ø 16-20-25

32-40-50-63

440x270x120 mm - 7,7 kg

311

heating plates for manual straight and slanted welding of PE, PP, PVC and PVDF pipes

CE

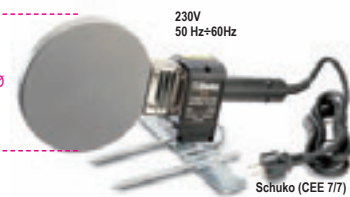

230V
50 Hz+60Hz
Schuko (CEE 7/7)

	Ø mm	Watt		
311/1	120	300	1	003110001
311/2	190	900	1	003110002

330

pipe cutters for steel gas pipes



	Ø mm - "	L mm		
330/2	10÷60 1/8"÷ 2"	380	1	003300002
330/4	60÷115 2"÷ 4"	585	1	003300004

330R/A

spare cutters for item 330 wheels for steel pipes



	Ø mm	S mm		
330R/A2	32	7	1	003300012
330R/A4	42	9	1	003300014

330R/I

spare cutter wheel for item 330 for stainless steel pipes



	Ø mm	S mm		
330R/I2	32	7	1	003300024
330R/I4	32	9	1	003300034

331L

ratcheting pipe cutter for copper and light alloy pipes



	Ø mm - "	L mm		
8÷29		180	1	003310008
5/16"÷1"1/8				

331LR/L

spare knife for pipe cutter 331L



	Ø mm		
331LR/L	18	1	003310058

332

mini pipe cutter for copper and light alloy pipes



	Ø mm - "	L mm		
3÷16		59	2	003320001
1/8"÷5/8"				

334

pipe cutter for copper and light alloy pipes



\emptyset mm - "	L mm		
3÷30 1/8"÷1"1/8	150	1	003340001

334R

spare cutter wheel for items 332 and 334 for copper and light alloy pipes



\emptyset mm			
334R 18	3 mm	1	003340021

334R/I

spare cutter wheel for items 332 and 334 for stainless steel pipes

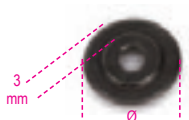

\emptyset mm			
334R/I 18	3 mm	1	003340023

336

telescopic pipe cutter for copper and light alloy pipes



\emptyset mm - "	L mm		
6÷38 1/4"÷1"1/2	160	1	003360001

338

telescopic pipe cutter, fast advance for copper, light alloys and plastic pipes



\emptyset mm - "	L mm		
6÷67 1/4"÷2"5/8	290	1	003380001

338R

spare cutter wheel for items 336 and 338 for copper and light alloy pipes



\emptyset mm			
338R 18,5	3 mm	1	003380022

338R/I

spare cutter wheel for items 336 and 338 for stainless steel pipes



\emptyset mm			
338R/I 21,8	4,8 mm	1	003380023

338RP

spare cutter wheel for items 336 and 338 for plastic pipes



\emptyset mm			
338RP 21,9	4,8 mm	1	003380025

339A

telescopic pipe cutter, fast advance for plastic pipes

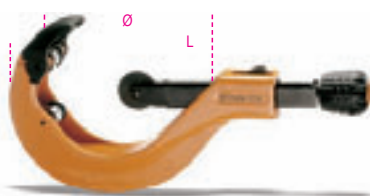

\emptyset mm - "	L mm		
50÷127 2"÷5"	345	1	003390011

339A/R

spare cutter wheels for item 339A



\emptyset mm			
339A/R 42	13 mm	1	003390061

341

pipe cutting pliers for plastic pipes



\emptyset mm	L mm		
0÷25	190	1	003410001

341RL

spare blade for item 341



341RL		1	003410010

341B

ratchet-type shears for plastic pipes



\emptyset mm	L mm		
0÷35	195	1	003410051

341B/RM

spare spring for item 341B

341B/RM		1	003410061

341B/RL

spare blade for item 341B



341B/RL		1	003410060

342

ratchet-type shears for plastic pipes



Ø	L	
mm - "	mm	
0÷42	200	1 003420030
1"5/8		

342MOL

spare spring for item 342

342MOL	1 003420033
--------	-------------

342RL

spare blade for item 342



342RL	1 003420032
-------	-------------

342A

ratchet-type shears for plastic pipes



Ø	L	
mm - "	mm	
0÷50	270	1 003420101
2"		

342A/MOL

spare spring for item 342A

342A/MOL	1 003420111
----------	-------------

342A/RL

spare blade for item 342A



342A/RL	1 003420110
---------	-------------

342P

ratchet-type shears for plastic pipes, made from magnesium alloy



Ø	L	
mm - "	mm	
0÷50	260	1 003420121
2"		

342P/RL

spare blade for item 342P



342P/RL	1 003420130
---------	-------------

345

pipe reamer metal body

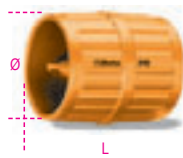

Ø	L	
mm - "	mm	
3÷42	58	5 003450001
1/8"÷1"5/8		

345U

pipe reamer for stainless steel, steel, copper and light alloys



Ø	L	
mm - "	mm	
4÷36	60	1 003450050
5/32"÷1"7/16		

345C

multilayer pipe gauge

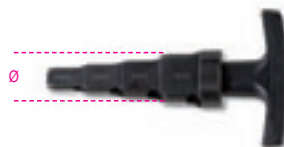

Ø		
mm		
16-20-26-32		1 003450032

345SB

deburrer with revolving replacement blade



L		
mm		
150	5	003450010

345SB/R

spare blade for item 345SB



345SB/R	3 003450015
---------	-------------

349

tube flaring tool with clutch, for copper and light alloy pipes



Ø		
mm - "		
6-8-10-12-14-15-16-18		1 003490001
(1/8-3/16-1/4-5/16		
3/8-1/2-5/8-3/4)		

270x200x50 mm - 2,7 kg

349/SMM

metric slide for item 349



Ø		
mm		
6-8-10-12-14-15-16-18		1 003490011

349/SMAS

inch slide for item 349



Ø		
"		
1/8-3/16-1/4-5/16		1 003490012
3/8-1/2-5/8-3/4		

350

tube flaring tool for copper and light alloy pipes



ø mm	L mm	A mm		
4-4,75-6-8 10-12-14	175	104	1	003500001

351C

pipe cutter and tube flaring tool



351C 1 003510010

334	Ø 3÷30 mm (1/8"÷1"1/8)
350	Ø 4÷14 mm
351P	Ø 4-4,75-6-8-10-12-14 mm

225x150x45 mm - 1,6 kg

351P

inserts for tube flaring tool item 350



	ø mm		
351P 4	4	3	003510101
351P 4,75	4,75	3	003510102
351P 6	6	3	003510103
351P 8	8	3	003510104
351P 10	10	3	003510105
351P 12	12	3	003510106
351P 14	14	3	003510107

352U

adjustable tube flaring tool for copper and light alloy pipes



ø mm - "	A mm		
5÷16 3/16÷5/8	130	1	003520101

352C/U

pipe cutter, deburrer and adjustable tube flaring tool



352C/U 1 003520110

334 Ø 3÷30 mm (1/8"÷1"1/8)

345SB

352U Ø 5÷16 mm (3/16"÷5/8")

335x145x60 mm - 2120 g

353N

tube expanding pliers, with interchangeable forms



L
mm
380 1 003530201

353NM

forms for tube expanding pliers item 353N

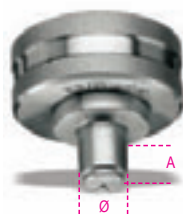

ø mm	A mm		
10	7	1	003530210
12	10	1	003530212
14	10	1	003530214
16	12	1	003530216
18	12	1	003530218
22	13	1	003530222

353N/C6

tube expanding pliers item 353N with forms item 353NM



353N/C6 1 003530300

353N

353NM Ø 10-12-14-16-18-22 mm

420x185x60 mm - 2,2 kg

355

combination spud wrench, five steps



ø "	L mm		
3/8"-1/2" 3/4"-1"	90	2	003550001

357F3

three-vial spirit level



ø "	L mm		
3/8" / 1/2"	90÷220	1	003570100

357R/F3

spare vial for item 357F3



357R/F3 1 003570101

358

tools for chamfering plastic pipes



	ø mm		
358/1	16÷110	1	003580001
358/2	40÷250	1	003580002

358RL

spare blade for items 358/1 and 358/2



358RL 1 003580011

359

universal drain wrench



Ø "	L mm	A mm	
1"÷1"1/4	160	140	1 003590001

359CH

drain adaptor, cross-shape for item 359



Ø "	L mm	
1"1/2	74	1 003590005

360

pipe wrenches, Stillson pattern



L mm	Ø max"	Ø max mm	
250	1" gas	34	1 003600025
350	1"1/2 gas	49	1 003600035
450	2" gas	60	1 003600045
600	2"1/2 gas	76	1 003600060
900	3"1/2 gas	102	1 003600090

360R/...

spare parts kit for item 360 with moving jaw and ring nut.

360R250	1 003600225
360R350	1 003600235
360R450	1 003600245
360R600	1 003600260
360R900	1 003600290

362

heavy duty pipe wrenches



L mm	Ø max"	Ø max mm	
200	1" gas	34	1 003620020
250	1"1/2 gas	49	1 003620025
300	2" gas	60	1 003620030
350	2" gas	60	1 003620035
450	2"1/2 gas	76	1 003620045
600	3" gas	90	1 003620060
900	5" gas	140	1 003620090

362R/...

spare parts kit for item 362 with: fixed jaw, moving jaw; ring nut; lockpin.

362R 200	1 003620220
362R 225	1 003620225
362R 300	1 003620230
362R 350	1 003620235
362R 450	1 003620245
362R 600	1 003620260
362R 900	1 003620290

363

heavy duty pipe wrenches made from light alloy



L mm	Ø max"	Ø max mm	
350	2" gas	60	1 003630035
450	2"1/2 gas	76	1 003630045
600	3" gas	90	1 003630060
900	5" gas	140	1 003630090
1200	6" gas	165	1 003630120

363R/...

spare parts kit for item 363 with: fixed jaw; moving jaw; ring nut; lockpin.

363R 350	1 003630235
363R 450	1 003630245
363R 600	1 003630260
363R 900	1 003630290
363R 1200	1 003630320

365

heavy duty pipe wrenches, offset pattern made from light alloy

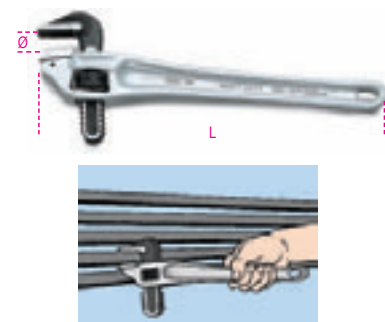

L mm	Ø max"	Ø max mm	
350	2" gas	60	1 003650035
450	2"1/2 gas	76	1 003650045

365R/...

spare parts kit for item 365 with: fixed jaw; moving jaw; ring nut; lockpin.

365R 350	1 003650235
365R 450	1 003650245

366

pipe wrenches, light pattern



L mm	Ø max"	Ø max mm	
175	1" gas	34	1 003660017
225	1"1/2 gas	49	1 003660022
275	2" gas	60	1 003660027
300	2"1/2 gas	76	1 003660030
350	3" gas	90	1 003660035

374

pipe wrenches, Swedish pattern, 45° slim jaws



DIN 5234

L mm	Ø max"	Ø max mm	
240	1/2" gas	21	1 003740024
320	1" gas	34	1 003740032
410	1"1/2 gas	49	1 003740041
550	2" gas	60	1 003740055
630	3" gas	90	1 003740063

375

pipe wrench, Swedish pattern, 45° flat jaws



DIN 5234

L mm	Ø max"	Ø max mm	
320	1" gas	34	1 003750032
410	1"1/2 gas	49	1 003750041
550	2" gas	60	1 003750055

376

pipe wrenches, Swedish pattern, 90° flat jaws



DIN 5234

L mm	Ø max"	Ø max mm	
320	1" gas	34	1 003760032
410	1"1/2 gas	49	1 003760041
550	2" gas	60	1 003760055
630	3" gas	90	1 003760063

378

pipe wrenches,
Swedish pattern, 45° slim jaws



DIN 5234

L mm	∅ max "	∅ max mm		
250	1/2" gas	21	1	003780025
320	1" gas	34	1	003780032
410	1 1/2" gas	49	1	003780041
550	2" gas	60	1	003780055
650	3" gas	90	1	003780065

374R/...

complete spare parts kit for items 374 - 375
- 376 - 378
with ring nut and ring nut stop

374R 240 x 374/240-378/250	1	003740724
374R 320 x 374/320-376/320-378/320	1	003740732
374R 410 x 374/410-375/410-376/410-378/410	1	003740741
374R 550 x 374/550-376/550-378/550	1	003740755
374R 630 x 374/630-378/650	1	003740763

383

reversible strip pipe wrenches



	∅ max "	∅ max mm	L mm		
383/1	3" gas	90	300	1	003830001
383/2	8" gas	220	300	1	003830002

383R

spare strips for item 383



	S mm		
383R/1	27	1	003830010
383R/2	27	1	003830015

384

reversible chain pipe wrench



∅ max "	∅ max mm	L mm		
4" gas	115	300	1	003840032

384RC

spare chain for item 384



384RC	1	003840033
-------	---	-----------

386A

heavy duty reversible
chain pipe wrenches



	∅ max gas	L mm		
386A/3	4" gas 115 mm	900	1	003860003
386A/4	6" gas 168 mm	900	1	003860004
386A/5	8" gas 220 mm	1100	1	003860005
386A/6	12" gas 324 mm	1300	1	003860006

386A/RC

spare chains for item 386A



386A/3/RC	1	003860013
386A/4/RC	1	003860014
386A/5/RC	1	003860015
386A/6/RC	1	003860016

388

pipe benders for thin walled copper,
light alloy and mild steel pipes

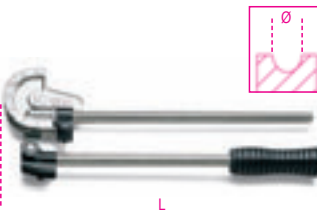

∅ mm	L mm		
6	305	1	003880006
8	315	1	003880008
10	350	1	003880010
12	360	1	003880012
14	455	1	003880014
15	465	1	003880015
16	465	1	003880016

388A

pipe bending pliers for thin walled
copper and light alloy pipes



	∅ mm	L mm		
388A/1	6-8-10 mm	220	1	003880051
388A/2	1/4"-5/16"-3/8"	220	1	003880055

388C/C8

pipe bender with 7 forms
for thin walled copper and light alloy pipes



	∅ mm		
388C/C8	10-12-14-16 18-20-22	1	003880200

400x330x110 mm - 3,6 kg

392C

adjustable drain tap pliers



∅ mm	L mm		
25+65	260	1	003920100

392RG/C

spare jaw protectors for item 392C, pair



392RG/C	1	003920101
---------	---	-----------

393

water tap wrench



L mm		
270	1	003930001



395

hinged water tap wrench

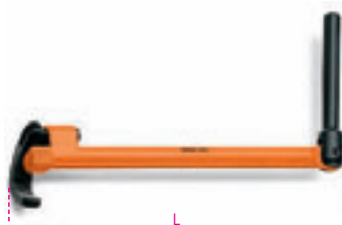

Ø	L	1
mm	mm	
15÷32 mm	240	1 003950001
5/8"÷1"1/4		

395T

telescopic hinged water tap wrench



Ø	L	1
mm	mm	
10÷32 mm	250÷430	1 003950100
3/8"÷1"1/4		

399

pivoting clamp vices



Ø	L min	1
mm	mm	
10÷60 mm	220	1 003990005
1/8÷2"		
10÷89 mm	290	1 003990010
1/8÷3"		

410

twist drills with cylindrical shanks, short series HSS, rolled

R ≤ 650 N/mm²
HV ~ 750÷820



DIN 338 ISO 235

Ø	L	L1	1
mm	mm	mm	
0,50	22	6	10 004100030
1,00	34	12	10 004100040
1,25	38	16	10 004100043
1,50	40	18	10 004100046
1,75	46	22	10 004100049
2,00	49	24	10 004100052
2,25	53	27	10 004100055

Ø	L	L1	1
mm	mm	mm	
2,50	57	30	10 004100058
2,75	61	33	10 004100061
3,00	61	33	10 004100064
3,20	65	36	10 004100066
3,25	65	36	10 004100067
3,50	70	39	10 004100070
3,75	70	39	10 004100073
4,00	75	43	10 004100076
4,20	75	43	10 004100078
4,25	75	43	10 004100079
4,50	80	47	10 004100082
4,75	80	47	10 004100085
5,00	86	52	10 004100088
5,25	86	52	10 004100091
5,50	93	57	10 004100094
5,75	93	57	10 004100097
6,00	93	57	10 004100100
6,25	101	63	10 004100103
6,50	101	63	10 004100106
6,75	109	69	10 004100109
7,00	109	69	10 004100112
7,50	109	69	10 004100118
8,00	117	75	10 004100124
8,50	117	75	10 004100130
9,00	125	81	5 004100136
9,50	125	81	5 004100142
10,00	133	87	5 004100148
10,50	133	87	5 004100172
11,00	142	94	5 004100184
11,50	142	94	5 004100196
12,00	151	101	5 004100210
12,50	151	101	5 004100222
13,00	151	101	5 004100234
14,00	160	108	5 004100242
15,00	169	114	5 004100250
16,00	178	120	5 004100258
17,00	186	125	3 004100262
18,00	194	130	3 004100266
19,00	202	135	3 004100270
20,00	210	140	3 004100274

410MIX/SEL19

set of 13 twist drills, item 410, and 6 twist drills with hard metal insets



410MIX/SEL19

1 004100417



Ø 1 - 1,5 - 2 - 2,5 - 3 - 3,5 - 4
4,5 - 5 - 5,5 - 6 - 8 - 10 mm

Ø 4 - 5 - 6 - 8 - 9 - 10 mm

410A

twist drills with cylindrical shanks, short series, HSS, rolled

R ≤ 650 N/mm²
HV ~ 750÷820



Ø	L	L1	1
mm	mm	mm	
13,50	160	108	5 004100281
14,00	160	108	5 004100283
14,50	169	114	5 004100285
15,00	169	114	5 004100287
15,50	178	120	5 004100289
16,00	178	120	5 004100291
16,50	186	125	3 004100292
17,00	186	125	3 004100293
17,50	194	130	3 004100294
18,00	194	130	3 004100295
18,50	202	135	3 004100296
19,00	202	135	3 004100297
19,50	210	140	3 004100298
20,00	210	140	3 004100299



410AS

twist drills with cylindrical shanks,
short series HSS, rolled

R ≤ 650 N/mm²
HV ~ 750+820



ANSI B94

Ø "	L mm	L1 mm		
1/16	48	22	10	004100371
5/64	51	25	10	004100372
3/32	57	32	10	004100373
7/64	67	38	10	004100374
1/8	70	41	10	004100375
9/64	73	44	10	004100376
5/32	79	51	10	004100377
11/64	83	54	10	004100378
3/16	89	59	10	004100379
13/64	92	62	10	004100380
7/32	95	64	10	004100381
15/64	98	67	10	004100382
1/4	102	70	10	004100383
17/64	105	73	10	004100384
9/32	108	75	10	004100385
19/64	111	78	10	004100386
5/16	114	81	10	004100387
21/64	117	84	10	004100388
11/32	121	87	5	004100389
23/64	124	89	5	004100390
3/8	127	92	5	004100391



410AS/SP21

Ø 1/16-5/64-3/32-7/64
1/8-9/64-5/32-11/64-3/16
13/64-7/32-15/64-1/4
17/64-9/32-19/64-5/16
21/64-11/32-23/64-3/8

410AS/SPV1



410AS/SEL21

Ø 1/16-5/64-3/32-7/64
1/8-9/64-5/32-11/64-3/16
13/64-7/32-15/64-1/4
17/64-9/32-19/64-5/16
21/64-11/32-23/64-3/8

412

twist drills with cylindrical shanks,
short series HSS entirely ground glossy
finishing

R ≤ 700 N/mm²
HV ~ 750+820



DIN 338 ISO 235

Ø mm	L mm	L1 mm		
0,50	22	6	10	004120030
1,00	34	12	10	004120040
1,25	38	16	10	004120043
1,50	40	18	10	004120046
1,75	46	22	10	004120049
2,00	49	24	10	004120052
2,25	53	27	10	004120055
2,50	57	30	10	004120058
2,75	61	33	10	004120061
3,00	61	33	10	004120064
3,25	65	36	10	004120067
3,50	70	39	10	004120070
3,75	70	39	10	004120073
4,00	75	43	10	004120076
4,25	75	43	10	004120079
4,50	80	47	10	004120082
4,75	80	47	10	004120085
5,00	86	52	10	004120088
5,25	86	52	10	004120091
5,50	93	57	10	004120094
5,75	93	57	10	004120097
6,00	93	57	10	004120100
6,25	101	63	10	004120103
6,50	101	63	10	004120106
6,75	109	69	10	004120109
7,00	109	69	10	004120112
7,25	109	69	5	004120115
7,50	109	69	5	004120118
7,75	117	75	5	004120121
8,00	117	75	5	004120124
8,25	117	75	5	004120127
8,50	117	75	5	004120130
8,75	125	81	5	004120133
9,00	125	81	5	004120136
9,25	125	81	5	004120139
9,50	125	81	5	004120142
9,75	133	87	5	004120145
10,00	133	87	5	004120148
10,25	133	87	5	004120149
10,50	133	87	5	004120150
10,75	142	94	5	004120151
11,00	142	94	5	004120152
11,25	142	94	5	004120153
11,50	142	94	5	004120154
11,75	142	94	5	004120155
12,00	151	94	5	004120156
12,25	151	101	5	004120157
12,50	151	101	5	004120158
12,75	151	101	5	004120159
13,00	151	101	5	004120160



412/SP19

Ø 1÷10 x 0,5 mm

412/SPV1

Ø 1÷13 x 0,5 mm

412/SPV2

Ø 1÷13 x 0,25 mm

412/SPV4

412/C150



412/C150

412

Ø 3 mm	n.
Ø 1 - 1,5 - 2 - 2,5 - 3 - 3,5 - 4 - 4,5 - 5 mm	10
Ø 5,5 - 6 - 6,5 - 7 - 7,5 - 8 - 8,5 - 9 - 9,5 - 10 mm	5

365x230x47 mm - 3,3 kg



412/SP91

Ø 1÷10 x 0,10 mm

412A

twist drills with cylindrical shanks,
short series, HSS entirely ground
burnished

R ≤ 700 N/mm²
HV ~ 750+820



DIN 338 ISO 235

Ø mm	L mm	L1 mm		
13,50	160	108	3	004120202
14,00	160	108	3	004120204
14,50	169	114	3	004120206
15,00	169	114	3	004120208
15,50	178	120	3	004120210
16,00	178	120	3	004120212
16,50	186	125	1	004120213
17,00	186	125	1	004120214
17,50	194	130	1	004120215
18,00	194	130	1	004120216
18,50	202	135	1	004120217
19,00	202	135	1	004120218
19,50	210	140	1	004120219
20,00	210	140	1	004120220

412L

twist drills with cylindrical shanks,
long series, HSS entirely ground
burnished

R ≤ 700 N/mm²
HV ~ 750-820



Ø mm	L mm	L1 mm		
2,00	85	56	10	004120232
2,50	95	62	10	004120234
3,00	100	66	10	004120236
3,50	112	73	10	004120238
4,00	119	78	10	004120240
4,50	126	82	10	004120242
5,00	132	87	10	004120244
5,50	139	91	10	004120246
6,00	139	91	10	004120248
6,50	148	97	5	004120250
7,00	156	102	5	004120252
8,00	165	109	5	004120256
9,00	175	115	5	004120260
10,00	184	121	5	004120264

414

twist drills with cylindrical shanks,
short series, HSS-TiN entirely ground

R ≤ 900 N/mm²
HV 0,05 ~ 2500



DIN 338 ISO 235

Ø mm	L mm	L1 mm		
1,00	34	12	10	004140040
1,25	38	16	10	004140042
1,50	40	18	10	004140046
1,75	46	22	10	004140048
2,00	49	24	10	004140052
2,25	53	27	10	004140054
2,50	57	30	10	004140058
2,75	61	33	10	004140060
3,00	61	33	10	004140064
3,25	65	36	10	004140066
3,50	70	39	10	004140070
3,75	70	39	10	004140072
4,00	75	43	10	004140076
4,25	75	43	10	004140078
4,50	80	47	10	004140082
4,75	80	47	10	004140084
5,00	86	52	10	004140088
5,25	86	52	10	004140090
5,50	93	57	10	004140094
5,75	93	57	10	004140096
6,00	93	57	10	004140100
6,25	101	63	10	004140102
6,50	101	63	10	004140106
6,75	109	69	10	004140108
7,00	109	69	10	004140112
7,25	109	69	5	004140114
7,50	109	69	5	004140118
7,75	117	75	5	004140120
8,00	117	75	5	004140124
8,25	117	75	5	004140125
8,50	117	75	5	004140130
8,75	125	81	5	004140132
9,00	125	81	5	004140136
9,25	125	81	5	004140138
9,50	125	81	5	004140142
9,75	133	87	5	004140144
10,00	133	87	5	004140148
10,50	133	87	5	004140150
11,00	142	94	5	004140152
11,50	142	94	5	004140154
12,00	151	101	5	004140156
12,50	151	101	5	004140158
13,00	151	101	5	004140160



414/SP19	
Ø 1÷10 x 0,5 mm	1 004140419
414/SPV1	1 004140420
414/SP25	1 004140425
Ø 1÷13 x 0,5 mm	
414/SPV2	1 004140426
414/SP49	1 004140429
Ø 1÷13 x 0,25 mm	
414/SPV4	1 004140430

414/C116



414/C116	
414	Ø 1 - 1,5 - 2 - 2,5 - 3 - 3,5 - 4 - 4,5 - 5 mm 10
	Ø 5,5 - 6 - 6,5 - 7 - 7,5 - 8 mm 3
	Ø 8,5 - 9 - 9,5 - 10 mm 2
365x230x47 mm - 2,7 Kg	

415

twist drills with cylindrical shanks,
short series, HSS-CO 8%
entirely ground

R ≤ 1400 N/mm²
HV ~ 850-920



DIN 338 ISO 235

Ø mm	L mm	L1 mm		
0,50	22	6	10	004150029
1,00	34	12	10	004150040
1,25	38	16	10	004150043
1,50	40	18	10	004150046
1,75	46	22	10	004150049
2,00	49	24	10	004150052
2,25	53	27	10	004150055
2,50	57	30	10	004150058
2,75	61	33	10	004150061
3,00	61	33	10	004150064
3,25	65	36	10	004150067
3,50	70	39	10	004150070
3,75	70	39	10	004150073
4,00	75	43	10	004150076
4,25	75	43	10	004150079
4,50	80	47	10	004150082
4,75	80	47	10	004150085
5,00	86	52	10	004150088

Ø mm	L mm	L1 mm		
5,25	86	52	10	004150091
5,50	93	57	10	004150094
5,75	93	57	10	004150097
6,00	93	57	10	004150100
6,25	101	63	10	004150103
6,50	101	63	10	004150106
6,75	109	69	10	004150109
7,00	109	69	10	004150112
7,25	109	69	5	004150115
7,50	109	69	5	004150118
7,75	117	75	5	004150121
8,00	117	75	5	004150124
8,25	117	75	5	004150127
8,50	117	75	5	004150130
8,75	125	81	5	004150133
9,00	125	81	5	004150136
9,25	125	81	5	004150139
9,50	125	81	5	004150142
9,75	133	87	5	004150145
10,00	133	87	5	004150148
10,25	133	87	5	004150149
10,50	133	87	5	004150150
10,75	142	94	5	004150151
11,00	142	94	5	004150152
11,25	142	94	5	004150153
11,50	142	94	5	004150154
11,75	142	94	5	004150155
12,00	151	101	5	004150156
12,25	151	101	5	004150157
12,50	151	101	5	004150158
12,75	151	101	5	004150159
13,00	151	101	5	004150160
14,00	160	108	3	004150164
15,00	169	114	3	004150168
16,00	178	120	3	004150172
17,00	186	125	1	004150174
18,00	194	130	1	004150176
19,00	202	135	1	004150178
20,00	210	140	1	004150180



415/SP19	
Ø 1÷10 x 0,5 mm	1 004150419
415/SPV1	1 004150420
415/SP25	1 004150425
Ø 1÷13 x 0,5 mm	
415/SPV2	1 004150426
415/SP49	1 004150431
Ø 1÷13 x 0,25 mm	
415/SPV4	1 004150432

415/C116



415/C116	
415	Ø 1 - 1,5 - 2 - 2,5 - 3 - 3,5 - 4 - 4,5 - 5 mm 10
	Ø 5,5 - 6 - 6,5 - 7 - 7,5 - 8 mm 3
	Ø 8,5 - 9 - 9,5 - 10 mm 2
365x230x47 mm - 2,7 kg	



415/SP91 1 004150460
 Ø 1=10 x 0,10 mm

416
 drill with cylindrical shank, specially ground,
 with two cutter pairs

R ≤ 900 N/mm²
 HV ▯ 820+850

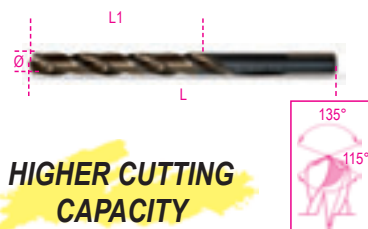

HIGHER CUTTING CAPACITY

DIN 338

Ø mm	L mm	L1 mm		
1,00	34	12	10	004160010
1,50	40	18	10	004160015
2,00	49	24	10	004160020
2,50	57	30	10	004160025
3,00	61	33	10	004160030
3,50	70	39	10	004160035
4,00	75	43	10	004160040
4,50	80	47	10	004160045
5,00	86	52	10	004160050
5,50	93	57	10	004160055
6,00	93	57	10	004160060
6,50	101	63	10	004160065
7,00	109	69	10	004160070
7,50	109	69	5	004160075
8,00	117	75	5	004160080
8,50	117	75	5	004160085
9,00	125	81	5	004160090
9,50	125	81	5	004160095
10,00	133	87	5	004160100

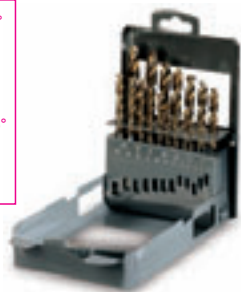
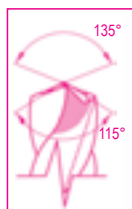

416/SP19 1 004160419
 Ø 1=10 x 0,5 mm

417
 helical cylindrical masonry drill bits,
 short series, made from milled steel
 with hard metal plates



DIN 8039

Ø mm	L mm		
3	70	10	004170003
4	75	10	004170004
5	85	10	004170005
5L	150	5	004170105
6	100	10	004170007
6L	150	5	004170106
7	120	10	004170009
8	120	10	004170010
8L	200	5	004170113
9	120	10	004170011
10	120	10	004170012
10L	200	5	004170120
12	150	10	004170014
12L	200	5	004170125
14	150	5	004170016
16	150	5	004170018



417/SP8 1 004170100
 Ø 3-4-5-6-8-9-10-12 mm

419
 hammer drill bits with milled shanks
 and hard metal plates



DIN 8039

ØxL mm		
4x110	10	004190002
5x110	10	004190004
5x160	10	004190006
6x110	10	004190012
6x160	10	004190014
6x210	10	004190016
7x160	10	004190028
8x110	10	004190030
8x160	10	004190032
8x210	10	004190034
8x260	10	004190036
8x460	10	004190042
9x160	5	004190044
10x160	5	004190050
10x210	5	004190052
10x260	5	004190054
10x310	5	004190056
10x460	5	004190060
12x160	5	004190064
12x210	5	004190066

ØxL mm		
12x260	5	004190068
12x460	5	004190074
14x160	3	004190086
14x260	3	004190090
14x310	3	004190092
14x460	3	004190096
16x210	3	004190112
16x250	3	004190114
16x300	3	004190116
16x450	3	004190120
18x250	1	004190124
20x310	1	004190128

423
 special end mills for welding
 HSS ground



Ø mm	L mm		
6	66	5	004230006
7	74	5	004230007
8	79	5	004230008
10	89	5	004230010

423A
 special mills for spot welding,
 HSS ground



DIN 1412/E

Ø mm	L mm		
6,5	40	1	004230015
8,0	40	1	004230020

424
 conical drill bits, HSS

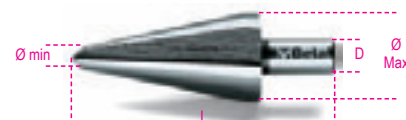

	L mm	Ø mm	D mm		
424/1	58	3÷14	6	2	004240001
424/2	63	6÷20	8	2	004240002
424/3	60	16÷30	10	2	004240003
424/4	80	3÷22	8	1	004240004
424/5	102	3÷31	10	1	004240005
424/6	86	26÷40	13	1	004240006
424/7	89	36÷50	13	1	004240007
424/8	90	40÷61	13	1	004240008





424/SP3	1	004240019
424/1+424/2+424/3		
Ø 3÷30 mm		
424/SPV	1	004240020

425

stepped drills, HSS



GR	L mm	Ø mm	S mm	D mm	
425/1	70	4÷12	1	6	2 004250010
425/2	55	4÷12	2	6	2 004250012
425/3	85	4÷20	2	10	2 004250015
425/4	85	12÷20	1	10	1 004250016
425/5	97	20÷30	1	10	1 004250017
425/6	75	4÷30	2	10	1 004250020
425/7	97	30÷40	1	13	1 004250025
425/8	100	40÷50	1	13	1 004250029



425/SP3	1	004250030
425/1+425/3+425/6		
Ø 4÷30 mm		
425/SPV	1	004250035

426

countersinking cutters with three cutters, HSS



DIN 335-C

GR	Ø mm	L mm	Ø1 mm	
1	4,3	44	4	3 004260001
2	5,3	44	4	3 004260002
3	6,3	44	5	3 004260003
4	7,3	44	6	3 004260004
5	8,3	50	6	3 004260005
6	9,4	50	6	3 004260006
7	10,4	54	6	3 004260007
8	12,4	54	8	3 004260008

GR	Ø mm	L mm	Ø1 mm	
9	15,0	56	10	3 004260009
10	16,5	60	10	3 004260010
11	20,5	63	10	3 004260011
12	25,0	66	10	3 004260012
13	28,0	71	12	3 004260013
14	31,0	71	12	3 004260014



426/SP6	1	004260030
GR 3-5-7-8-10-11		
Ø 6,3÷20,5 mm		
426/SPV	1	004260035

426SB

countersinking cutters, HSS



GR	Ø mm	D mm	L mm	
426/SB1	1	2÷5	6 45	1 004260101
426/SB2	2	5÷10	8 48	1 004260102
426/SB3	3	10÷15	10 65	1 004260103
426/SB4	4	15÷20	12 85	1 004260104
426/SB5	5	20÷25	15 102	1 004260105
426/SB6	6	25÷30	15 115	1 004260106



426SB/SP4	1	004260130
426/SB1-426/SB2		
426/SB3-426/SB4		
Ø 2÷20 mm		
426SB/SPV1	1	004260135

426MD

rotary files, made from hard metal

cross cut HM6



	L mm	Ø mm	
426MD/CP8	63	8	1 004260512
426MD/CP12	70	12	1 004260522
426MD/CT8	64	8	1 004260513
426MD/CT12	69	12	1 004260523
426MD/F8	64	8	1 004260514
426MD/F12	69	12	1 004260524
426MD/T8	65	8	1 004260516
426MD/T12	69	12	1 004260526
426MD/S8	52	8	1 004260518
426MD/S12	54	12	1 004260528
426MD/FA8	62	8	1 004260519
426MD/FA12	70	12	1 004260529



426MD/SP10	1	004260510
426MD/CP-426MD/CT-426MD/F		
426MD/T-426MD/S		
Ø 8-12 mm		

427

morse taper extractors



DIN 317

GR	L mm	A mm	
0	92	13	3 004270000
1-2	140	19	3 004270002
3	190	25	3 004270003
4	225	30	3 004270004
5-6	260	35	3 004270006



428FP

machine taps for clearance holes,
coarse pitch threads, HSS



ISO 529

M	mm	L	L1		
3x0,5	2,7	56	11	10	004280003
4x0,7	3,4	63	13	10	004280004
5x0,8	4,9	70	16	10	004280005
6x1	4,9	80	19	10	004280006
8x1,25	6,2	90	22	10	004280008
10x1,5	8,0	100	24	10	004280010
12x1,75	7,0	110	29	5	004280012
14x2	9,0	110	30	5	004280014
16x2	9,0	110	30	5	004280016
18x2,5	11,0	125	34	3	004280018
20x2,5	12,0	140	34	3	004280020
22x2,5	14,5	140	34	3	004280022
24x3	14,5	160	38	3	004280024

428FC

machine taps for blind holes,
coarse pitch threads, HSS

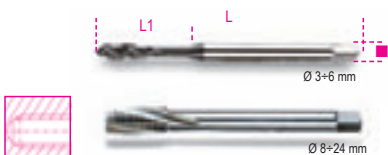

ISO 529

M	mm	L	L1		
3x0,5	2,7	56	11	10	004280103
4x0,7	3,4	63	13	10	004280104
5x0,8	4,9	70	16	10	004280105
6x1	4,9	80	19	10	004280106
8x1,25	6,2	90	22	10	004280108
10x1,5	8,0	100	24	10	004280110
12x1,75	7,0	110	29	5	004280112
14x2	9,0	110	30	5	004280114
16x2	9,0	110	30	5	004280116
18x2,5	11,0	125	34	3	004280118
20x2,5	12,0	140	34	3	004280120
22x2,5	14,5	140	34	3	004280122
24x3	14,5	160	38	3	004280124

428/C14

assortment of 14 machine taps
items 428FP + 428FC



428/C14	1	004280201
428FP M3=12		
428FC M3=12		
428/SPV	1	004280202

429FP

machine taps for clearance holes,
coarse pitch threads HSS-CO 5%



ISO 529

M	mm	L	L1		
3x0,5	2,7	56	11	5	004290003
4x0,7	3,4	63	13	5	004290004
5x0,8	4,9	70	16	5	004290005
6x1	4,9	80	19	5	004290006
8x1,25	6,2	90	22	5	004290008
10x1,5	8,0	100	24	5	004290010
12x1,75	7,0	110	29	5	004290012
14x2	9,0	110	30	5	004290014

429FC

machine taps for blind holes,
coarse pitch threads HSS-CO 5%

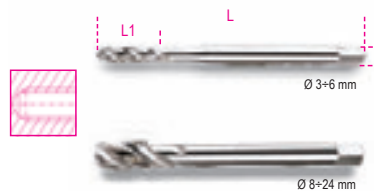

ISO 529

M	mm	L	L1		
3x0,5	2,7	56	11	5	004290103
4x0,7	3,4	63	13	5	004290104
5x0,8	4,9	70	16	5	004290105
6x1	4,9	80	19	5	004290106
8x1,25	6,2	90	22	5	004290108
10x1,5	8,0	100	24	5	004290110
12x1,75	7,0	110	29	5	004290112
14x2	9,0	110	30	5	004290114

429/C14

assortment of 14 machine taps
items 429FP + 429FC



429/C14	1	004290201
429FP M3=12		
429FC M3=12		
428/SPV	1	004280202

430

hand taps, **coarse pitch**, metric thread
made from chrome-steel



ISO 529

M	mm	L	L1		
2x0,4	2,5	36	11	5	004300002
3x0,5	2,5	40	12	5	004300003
4x0,7	3,0	45	14	5	004300004
5x0,8	4,0	48	16	5	004300005
6x1	5,0	50	18	5	004300006
7x1	4,5	50	18	5	004300007
8x1,25	5,0	56	22	3	004300008
9x1,25	5,5	63	22	3	004300009
10x1,5	6,0	70	25	3	004300010
11x1,5	7,0	70	25	3	004300011
12x1,75	7,0	75	30	3	004300012
14x2	8,0	80	32	3	004300014
16x2	10,0	80	32	3	004300016
18x2,5	11,0	95	40	1	004300018
20x2,5	12,0	95	40	1	004300020
22x2,5	14,5	100	40	1	004300022
24x3	14,5	110	50	1	004300024



430/SP21	1	004300201
M 3-4-5-6-8-10-12		
430/SPV	1	004300202

430ASW

hand taps, **Whitworth** thread
made from chrome-steel



DIN 352

BSW	mm	L	L1		
1/8x40	2,7	40	12	5	004300031
5/32x32	3,4	45	14	5	004300032
3/16x24	4,3	48	18	5	004300033
1/4x20	4,9	50	22	5	004300034
5/16x18	4,9	56	25	3	004300035
3/8x16	5,5	70	28	3	004300036
7/16x14	6,2	70	30	3	004300037
1/2x12	7,0	75	32	3	004300038
9/16x12	9,0	80	32	1	004300039
5/8x11	9,0	80	38	1	004300040
3/4x10	11,0	95	40	1	004300041
7/8x9	14,5	100	40	1	004300042
1"x8	16,0	110	50	1	004300043

430ASC

hand taps, **UNC** thread
made from chrome-steel



ANSI B.1

UNC	mm	L	L1		
1/4x20	4,9	70	30	5	004300051
5/16x18	4,9	70	30	5	004300052
3/8x16	5,5	75	35	3	004300053
7/16x14	6,2	80	40	3	004300054
1/2x13	7,0	85	45	3	004300055
9/16x12	9,0	90	45	3	004300056
5/8x11	9,0	100	47	3	004300057
3/4x10	11,0	110	50	3	004300058
7/8x9	14,5	120	60	1	004300059
1"x8	16,0	130	60	1	004300060

431

hand taps, **coarse pitch**,
metric thread HSS

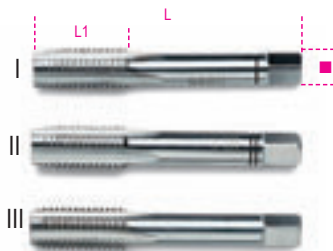

DIN 352 UNI 4535

M	mm	L	L1		
3x0,5	2,5	40	12	5	004310003
4x0,7	3,0	45	14	5	004310004
5x0,8	4,0	48	16	5	004310005
6x1	5,0	50	18	5	004310006
7x1	5,0	50	18	5	004310007
8x1,25	5,0	56	22	3	004310008

M	mm	L	L1		
10x1,5	6,0	70	25	3	004310010
12x1,75	7,0	75	30	3	004310012
14x2	9,0	80	32	1	004310014
16x2	9,0	80	32	1	004310016
18x2,5	11,0	95	40	1	004310018
20x2,5	12,0	95	40	1	004310020
22x2,5	12,0	100	40	1	004310022
24x3	14,5	110	50	1	004310024



431/SP21
M 3-4-5-6-8-10-12
431/SPV
1 004310201
1 004310202

433

hand taps, **fine pitch**, metric thread
made from chrome-steel

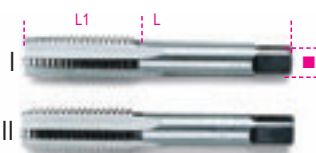

DIN 2181 UNI 4535

M	mm	L	L1		
6x0,75	4,5	48	16	5	004330201
7x0,75	4,5	56	18	5	004330202
8x0,75	5,0	50	16	5	004330203
8x1	5,0	56	16	5	004330204
9x0,75	6,0	63	22	5	004330205
9x1	6,0	63	22	5	004330206
10x0,75	6,5	63	18	5	004330207
10x1	6,5	63	18	5	004330208
10x1,25	6,5	63	18	5	004330209
11x0,75	7,0	70	25	3	004330210
11x1	7,0	70	25	3	004330211
11x1,25	7,0	70	25	3	004330212
12x0,75	7,0	70	20	3	004330213
12x1	7,0	70	20	3	004330214
12x1,25	7,0	70	20	3	004330215
12x1,5	7,0	70	20	3	004330216
14x1	8,0	80	32	1	004330217
14x1,25	8,0	80	32	1	004330218
14x1,5	8,0	80	32	1	004330219
16x1	10,0	80	32	1	004330220
16x1,5	10,0	80	32	1	004330221
18x1,5	11,0	95	40	1	004330222
18x2	11,0	80	25	1	004330223
20x1,5	14,5	80	22	1	004330224
22x1,5	14,5	80	22	1	004330225
24x1,5	14,5	80	22	1	004330226
24x2	14,5	80	22	1	004330227

433ASF

hand taps, **fine pitch**, UNF thread
made from chrome-steel

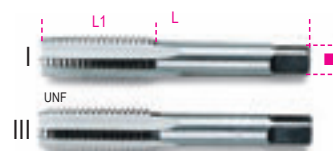

ANSI B.1

UNF	mm	L	L1		
1/4x28	4,9	70	30	5	004330301
5/16x24	4,9	70	30	5	004330302
3/8x24	5,5	75	35	3	004330303
7/16x20	6,2	80	40	3	004330304
1/2x20	7,0	85	45	3	004330305
9/16x18	9,0	90	45	3	004330306
5/8x18	9,0	100	47	3	004330307
3/4x16	11,0	110	50	3	004330308
7/8x14	14,5	120	60	1	004330309
1"x12	16,0	130	60	1	004330310

433ASG

hand taps, cylindrical **GAS** (BSP) thread
made from chrome-steel



DIN 5157

GAS	mm	L	L1		
1/8x28	5,5	65	18	1	004330401
1/4x19	9,0	70	24	1	004330402
3/8x19	9,0	75	25	1	004330403
1/2x14	12,0	80	31	1	004330405
3/4x14	16,0	90	33	1	004330408
1"x11	20,0	100	39	1	004330410

434

hand taps, **fine pitch**, metric thread HSS

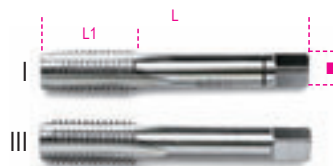

DIN 2181 UNI 4535

M	mm	L	L1		
6x0,75	4,5	48	16	5	004340001
8x0,75	5,0	56	16	5	004340003
8x1	5,0	56	16	5	004340004
10x0,75	6,5	63	18	5	004340007
10x1	6,5	63	18	5	004340008
10x1,25	6,5	63	18	5	004340009
12x1	7,0	70	20	3	004340014
12x1,25	7,0	70	20	3	004340015
12x1,5	7,0	70	20	3	004340016
13x1,5	9,0	70	20	1	004340017
14x1	9,0	70	20	1	004340018
14x1,25	9,0	70	20	1	004340019
14x1,5	9,0	70	20	1	004340020
15x1,5	9,0	70	20	1	004340021
16x1	9,0	70	20	1	004340022
16x1,5	9,0	70	20	1	004340023
18x1,5	11,0	80	22	1	004340024
18x2	11,0	90	25	1	004340025
20x1,25	12,0	80	22	1	004340026

M	mm	L	L1		
20x1,5	12,0	80	22	1	004340027
20x2	12,0	90	25	1	004340028
22x1,5	14,5	80	22	1	004340029
24x1	14,5	80	22	1	004340030
24x1,5	14,5	80	22	1	004340031
24x2	14,5	80	22	1	004340032

435

adjustable tap wrenches, steel body



DIN 1814

	mm	L		
435/0	2÷5 M2÷M8	140	3	004350007
435/1	2÷6 M3÷M10	180	2	004350009
435/1,5	2,5÷6 M3÷M12	180	2	004350011
435/2	3÷7 M4÷M12	260	2	004350013
435/3	4÷12 M5÷M20	380	1	004350020
435/4	5,5÷16 M9÷M27	490	1	004350027
435/5	7÷18 M13÷M32	620	1	004350032

435G

adjustable tap wrenches, light alloy body



DIN 1814

	mm	L		
435G/0	2÷5 M1÷M8	130	5	004350108
435G/1	2÷6 M1÷M10	190	5	004350110
435G/1,5	2÷7 M2÷M12	175	5	004350112
435G/2	3,4÷7 M4÷M12	280	5	004350114
435G/3	4,9÷12 M5÷M20	380	2	004350121
435G/4	7÷16 M11÷M27	500	2	004350127
435G/5	7÷18 M13÷M32	700	1	004350132
435G/6	11÷24 M18÷M42	800	1	004350142

436

reversible ratcheting tap wrenches

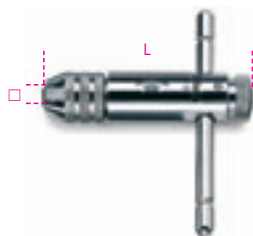

	mm	L		
436/1	2÷5 M3÷M8	85	5	004360002
436/2	4,6÷8 M5÷M12	110	5	004360004

Beta

436L

reversible ratcheting tap wrenches, long series



	mm	L		
436L/1	2÷5 M3÷M8	245	2	004360012
436L/2	4,6÷8 M5÷M12	295	2	004360014

436R

spare clamps for items 436 and 436L

436R/1	1	004360022
436R/2	1	004360024

437U/09

assortment for repairing damaged threads
M5-M6-M8-M10-M12



25 x M5, M6, M8, M10
10 x M12

437U/09	1	004370550
M5X0,8		
M6X1,0		
M8X1,25		
M10X1,5		
M12X1,75		

370x230x55 mm - 2 Kg

437U/E-M...

stainless steel helicoids



	H		
M5	7,5	1	004370555
M6	9	1	004370556
M8	12	1	004370558
M10	15	1	004370560
M12	18	1	004370562

Prices refer to 25 pieces (10 for size M12)

437U/PM

bits and taps for item 437U/09



M5	1	004370565
M6	1	004370566
M8	1	004370568
M10	1	004370570
M12	1	004370572

438A

set of bits for drilling, threading and countersinking, HSS

- M3 - M4 - M5 - M6 - M8 - M10
- with magnetic bit holder



S MAX mm = Ø mm

438A	1	004380010
------	---	-----------

438...

bits for drilling, threading and countersinking

HSS, 1/4" drive

1/4"



	S max		
M3	3	2	004380103
M4	4	2	004380104
M5	5	2	004380105
M6	6	2	004380106
M8	8	2	004380108
M10	10	2	004380110

Beta

440

round dies, **coarse pitch**,
metric thread made from chrome-steel



UNI EN 22568

M	Ø mm		
2x0,4	25,4	5	004400002
3x0,5	25,4	5	004400003
4x0,7	25,4	5	004400004
5x0,8	25,4	5	004400005
6x1	25,4	5	004400006
7x1	25,4	5	004400007
8x1,25	25,4	5	004400008
9x1,25	25,4	5	004400009
10x1,5	25,4	5	004400010
12x1,75	25,4	5	004400012

440A

round dies, **coarse pitch**,
metric thread made from chrome-steel

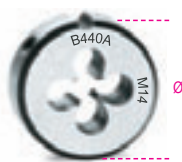

UNI EN 22568

M	Ø mm		
10x1,5	38,1	3	004400110
11x1,5	38,1	3	004400111
12x1,75	38,1	3	004400112
14x2	38,1	3	004400114
16x2	38,1	3	004400116
18x2,5	38,1	3	004400118
20x2,5	38,1	3	004400120

440B

round dies, **coarse pitch**,
metric thread made from chrome-steel



UNI EN 22568

M	Ø mm		
18x2,5	50,8	3	004400122
20x2,5	50,8	3	004400124
22x2,5	50,8	3	004400126
24x3	50,8	3	004400128

440ASW

round dies, **Whitworth thread**
made from chrome-steel



BSW	Ø mm		
1/8x40	25,4	5	004400201
5/32x32	25,4	5	004400202
3/16x24	25,4	5	004400203
1/4x20	25,4	5	004400204
5/16x18	25,4	5	004400205
3/8x16	38,1	3	004400206
7/16x14	38,1	3	004400207
1/2x12	38,1	3	004400208
9/16x12	38,1	3	004400209
5/8x11	50,8	3	004400210
3/4x10	50,8	3	004400211
7/8x9	50,8	3	004400212
1"x8	50,8	3	004400213

440ASC

round dies, **coarse pitch**,
UNC thread made from chrome-steel



UNC	Ø mm		
1/4x20	25,4	5	004400221
5/16x18	25,4	5	004400222
3/8x16	38,1	3	004400223
7/16x14	38,1	3	004400224
1/2x13	38,1	3	004400225
9/16x12	38,1	3	004400226
5/8x11	50,8	3	004400227
3/4x10	50,8	3	004400228
7/8x9	50,8	3	004400229
1"x8	50,8	3	004400230

440ASF

round dies, **fine pitch**,
UNF thread made from chrome-steel

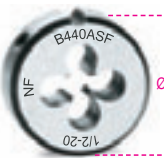

ANSI B1.1

UNF	Ø mm		
1/4x28	25,4	5	004400241
5/16x24	25,4	5	004400242
3/8x24	38,1	3	004400243
7/16x20	38,1	3	004400244
1/2x20	38,1	3	004400245
9/16x18	38,1	3	004400246
5/8x18	50,8	3	004400247
3/4x16	50,8	3	004400248
7/8x14	50,8	3	004400249
1"x12	50,8	3	004400250

440ASG

round dies, cylindrical **GAS** (BSP) thread
made from chrome-steel



UNI EN 22568

GAS	Ø mm		
1/8x28	38,1	3	004400255
1/4x19	38,1	3	004400256
3/8x19	38,1	3	004400257
1/2x14	50,8	3	004400259
3/4x14	50,8	3	004400260
1"x11	63,5	3	004400261

441

round dies, **fine pitch**, metric thread
made from chrome-steel

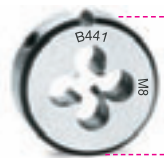

UNI EN 22568

M	Ø mm		
6x0,75	25,4	5	004410004
7x0,75	25,4	5	004410005
8x0,75	25,4	5	004410006
8x1	25,4	5	004410007
9x0,75	25,4	5	004410008
9x1	25,4	5	004410009

441A

round dies, **fine pitch**, metric thread
made from chrome-steel

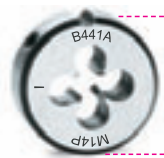

UNI EN 22568

M	Ø mm		
10x0,75	38,1	3	004410100
10x1	38,1	3	004410101
10x1,25	38,1	3	004410102
11x0,75	38,1	3	004410103
11x1	38,1	3	004410104
11x1,25	38,1	3	004410105
12x0,75	38,1	3	004410106
12x1	38,1	3	004410107
12x1,25	38,1	3	004410108
12x1,5	38,1	3	004410109
14x1	38,1	3	004410110
14x1,25	38,1	3	004410111
14x1,5	38,1	3	004410112
16x1	38,1	3	004410113
16x1,5	38,1	3	004410114
18x1,5	38,1	3	004410115

441B

round dies, **fine pitch**, metric thread
made from chrome-steel



UNI EN 22568

M	Ø mm		
18x1,5	50,8	3	004410117
18x2	50,8	3	004410118
20x1,5	50,8	3	004410119
22x1,5	50,8	3	004410120
24x1,5	50,8	3	004410121
24x2	50,8	3	004410122

442

round dies, **coarse pitch**, metric thread HSS



UNI EN 22568

M	ØxS mm		
3x0,5	20x5	3	004420003
4x0,7	20x5	3	004420004
5x0,8	20x7	3	004420005
6x1	20x7	3	004420006
7x1	25x9	3	004420007
8x1,25	25x9	3	004420008
10x1,5	30x11	3	004420010
12x1,75	38x14	3	004420012
14x2	38x14	1	004420014
16x2	45x18	1	004420016
18x2,5	45x18	1	004420018
20x2,5	45x18	1	004420020
22x2,5	55x22	1	004420022
24x3	55x22	1	004420024

443

round dies, **fine pitch**, metric thread HSS



UNI EN 22568

M	ØxS mm		
6x0,75	20x7	1	004430107
8x0,75	25x9	1	004430110
8x1	25x9	1	004430111
10x0,75	30x11	1	004430113
10x1	30x11	1	004430114
10x1,25	30x11	1	004430115
12x1	38x10	1	004430116
12x1,25	38x10	1	004430117
12x1,5	38x10	1	004430118
13x1,5	38x10	1	004430119
14x1	38x10	1	004430120
14x1,25	38x10	1	004430121
14x1,5	38x10	1	004430122
15x1,5	38x10	1	004430123
16x1	45x14	1	004430124
16x1,5	45x14	1	004430125

M	ØxS mm		
18x1,5	45x14	1	004430127
20x1,25	45x14	1	004430129
20x1,5	45x14	1	004430130
20x2	45x14	1	004430131
22x1,5	55x16	1	004430132
24x1	55x16	1	004430133
24x1,5	55x16	1	004430135
24x2	55x16	1	004430136

444

die stocks, steel body



DIN 225

	Ø mm	L mm		
444	20x5	215	5	004440005
444/0	20x7	215	5	004440007
444/1	25,4	225	5	004440025
444/1A	25x9	225	5	004440027
444/1B	30x11	300	5	004440030
444/C	38x10	315	3	004440033
444/1C	38x14	315	3	004440035
444/2	38,1x12,7	360	3	004440038
444/1D	45x14	455	1	004440045
444/2D	45x18	455	1	004440046
444/3	50,8	555	1	004440050
444/4	55x16	555	1	004440055
444/5A	63,5	630	1	004440057

444G

die stocks, light alloy body



UNI EN 22568

	Ø mm	L mm		
444G/A	16x5	160	5	004440103
444G	20x5	200	5	004440105
444G/0	20x7	200	5	004440107
444G/1	25,4	210	5	004440125
444G/1A	25x9	224	5	004440127
444G/1B	30x11	280	5	004440130
444G/C	38x10	315	3	004440133
444G/1C	38x14	315	3	004440135
444G/2	38,1	320	3	004440138
444G/1D	45x14	450	1	004440145
444G/2D	45x18	450	1	004440146
444G/3	50,8	500	1	004440150
444G/4	55x16	560	1	004440155
444G/5A	63,5	620	1	004440163
444G/6	65x18	630	1	004440165

446/C30

assortment of chrome-steel taps
and dies, metric thread,
and accessories in wooden case



446/C30

1 004460055

325x220x35 mm - 3,2 Kg

430 M	440 M		
3x0,5	3x0,5	435/1,5	444/1
4x0,7	4x0,7		
5x0,8	5x0,8		
6x1	6x1		
8x1,25	8x1,25		
10x1,5	10x1,5		
12x1,75	12x1,75		

446/C48

assortment of chrome-steel taps
and dies, metric thread,
and accessories in wooden case



446/C48

1 004460057

580x300x50 mm - 5 Kg

430 M	440 M	440A M		
3x0,5	3x0,5	10x1,5	435/1	444/1
4x0,7	4x0,7	12x1,75	435/3	444/2
5x0,8	5x0,8	14x2		
6x1	6x1	16x2		
8x1,25	8x1,25	18x2,5		
10x1,5		20x2,5		
12x1,75				
14x2				
16x2				
18x2,5				
20x2,5				

Beta

446/C110

assortment of chrome-steel taps and dies, metric thread, and accessories for car repair jobs in wooden case



446/C110 1 004460060

500x337x60 mm - 8,1 Kg

430		433		440/440A, 441/441A	
M	M	M	M	M	M
mm	mm	mm	mm	mm	mm
2x0,4	6x0,75	2x0,4	6x0,75		
3x0,5	7x0,75	3x0,5	7x0,75		
4x0,7	8x0,75	4x0,7	8x0,75		
5x0,8	8x1	5x0,8	8x1		
6x1	9x0,75	6x1	9x0,75		
7x1	9x1	7x1	9x1		
8x1,25	10x0,75	8x1,25	10x0,75		
9x1,25	10x1	9x1,25	10x1		
10x1,5	10x1,25	10x1,5	10x1,25		
11x1,5	11x0,75	11x1,5	11x0,75		
12x1,75	11x1	12x1,75	11x1		
14x2	11x1,25	14x2	11x1,25		
16x2	12x0,75	16x2	12x0,75		
	12x1		12x1		
	12x1,25		12x1,25		
	12x1,5		12x1,5		
	14x1		14x1		
	14x1,25		14x1,25		
	14x1,5		14x1,5		
	16x1		16x1		
	16x1,5		16x1,5		
	18x1,5		18x1,5		

435/0	444/1	436/1
435/3	444/2	

446ASF/C29

assortment of chrome-steel taps and dies, UNF thread, and accessories in wooden case



446ASF/C29 1 004460070

660x410x50 mm - 6 Kg

433ASF	440ASF		
1/4	1/4	435/1,5	444/1
5/16	5/16	435/3	444/2
3/8	3/8		444/3
7/16	7/16		
1/2	1/2		
9/16	9/16		
5/8	5/8		
3/4	3/4		

446ASW/C36

assortment of chrome-steel taps and dies, Whitworth thread, and accessories in wooden case



446ASW/C36 1 004460075

525x310x50 mm - 3,4 Kg

430ASW	440ASW		
1/8	1/8	435/1,5	444/1
5/32	5/32	435/2	444/2
3/16	3/16		
1/4	1/4		
5/16	5/16		
3/8	3/8		
7/16	7/16		
1/2	1/2		

446ASC/C37

assortment of chrome-steel taps and dies, UNC thread, and accessories in wooden case



446ASC/C37 1 004460080

660x410x50 mm - 6,7 Kg

430ASC	440ASC		
1/4	1/4	435/1,5	444/1
5/16	5/16	435/3	444/2
3/8	3/8		444/3
7/16	7/16		
1/2	1/2		
9/16	9/16		
5/8	5/8		
3/4	3/4		

446ASG/C23

assortment of chrome-steel taps and dies, cylindrical GAS thread, and accessories in wooden case



446ASG/C23 1 004460085

700x430x70 mm - 9,8 Kg

433ASG	440ASG		
1/8	1/8	435/3	444/2
1/4	1/4	435/5	444/3
3/8	3/8		444/5A
1/2	1/2		
3/4	3/4		
1"	1"		

447/C37

assortment of HSS taps and dies, metric thread, and accessories in metal case



447/C37 1 004470055

380x185x35 mm - 3,9 Kg

431 M mm	442 M mm		
3x0,5	3x0,5	435/0	444
4x0,7	4x0,7	435/2	444/0
5x0,8	5x0,8		444/1A
6x1	6x1		444/1B
8x1,25	8x1,25		444/1C
10x1,5	10x1,5		
12x1,75	12x1,75		

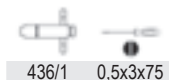

447/C53

assortment of HSS taps and dies, metric thread, and accessories in metal case



447/C53 1 004470060

500x235x50 mm - 9 Kg

431 M mm	442 M mm			
3x0,5	3x0,5	435/1,5	444	436/1
4x0,7	4x0,7	435/3	444/0	436/2
5x0,8	5x0,8		444/1A	
6x1	6x1		444/1B	
8x1,25	8x1,25		444/1C	
10x1,5	10x1,5		444/2D	
12x1,75	12x1,75			
14x2	14x2			
16x2	16x2			
18x2,5	18x2,5			
20x2,5	20x2,5			

447/C70

assortment of HSS taps and dies, metric thread, and accessories for car repair jobs industrial maintenance in wooden case



447/C70 1 004470065

510x340x70 mm - 7,5 Kg

431 M mm	434 M mm	442 M mm	443 M mm
3x0,5	8x1	3x0,5	8x1
4x0,7	10x1,25	4x0,7	10x1,25
5x0,8	12x1,25	5x0,8	12x1,25
6x1	12x1,5	6x1	12x1,5
7x1	14x1,25	7x1	14x1,25
8x1,25	14x1,5	8x1,25	14x1,5
10x1,5	16x1,5	10x1,5	16x1,5
12x1,75	12x1,75		
14x2	14x2		
16x2	16x2		

435/0	444	436/1
435/3	444/0	
	444/1A	
	444/1B	
	444/1C	
	444/1D	

450

holesaws HSS, Bimetal

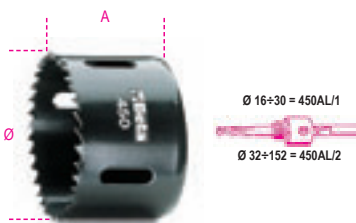

HSS-Co 8%

Ø mm	Ø	A mm	
16	(5/8)	57	1 004500016
17	(11/16)	57	1 004500017
19	(3/4)	51	1 004500019
20	-	51	1 004500020
21	(13/16)	51	1 004500021
22	(7/8)	51	1 004500022
24	(15/16)	51	1 004500024
25	(1")	51	1 004500025
27	(1"1/16)	51	1 004500027
29	(1"1/8)	51	1 004500029
30	(1"3/16)	51	1 004500030
32	(1"1/4)	51	1 004500032
33	(1"5/16)	51	1 004500033
35	(1"3/8)	51	1 004500035
37	(1"7/16)	51	1 004500037
38	(1"1/2)	44	1 004500038

Ø mm	Ø	A mm	
40	(1"9/16)	44	1 004500040
41	(1"5/8)	44	1 004500041
43	(1"11/16)	44	1 004500043
44	(1"3/4)	44	1 004500044
46	(1"13/16)	44	1 004500046
48	(1"7/8)	44	1 004500048
51	(2")	44	1 004500051
52	(2"1/16)	44	1 004500052
54	(2"1/8)	44	1 004500054
57	(2"1/4)	44	1 004500057
59	(2"5/16)	44	1 004500059
60	(2"3/8)	44	1 004500060
64	(2"1/2)	44	1 004500064
65	(2"9/16)	44	1 004500065
67	(2"5/8)	44	1 004500067
68	-	44	1 004500068
70	(2"3/4)	44	1 004500070
73	(2"7/8)	44	1 004500073
76	(3")	44	1 004500076
79	(3"1/8)	44	1 004500079
83	(3"1/4)	44	1 004500083
86	(3"3/8)	44	1 004500086
89	(3"1/2)	44	1 004500089
92	(3"5/8)	44	1 004500092
95	(3"3/4)	44	1 004500095
98	(3"7/8)	44	1 004500098
102	(4")	44	1 004500102
105	(4"1/8)	44	1 004500105
108	(4"1/4)	44	1 004500108
111	(4"3/8)	44	1 004500111
114	(4"1/2)	44	1 004500114
121	(4"3/4)	44	1 004500121
127	(5")	44	1 004500127
140	(5"1/2)	44	1 004500140
152	(6")	44	1 004500152

450AL

arbors for holesaws

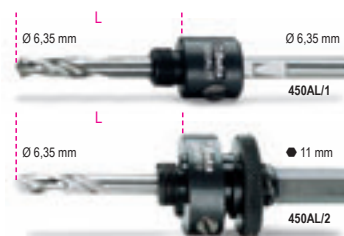

	Ø mm	L mm	
450AL/1	16±30	54	1 004500210
450AL/2	32±152	70	1 004500215

450AD

adaptors for arbors item 450AL/1



	Ø mm	
450AD	32±51	1 004500230



450PA/1

pilot drills for arbors item 450AL/1, HSS



ØxL
mm
6,35x105

1 004500252

450PA/2

pilot drills for arbors item 450AL/2, HSS

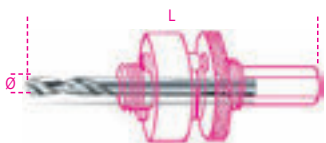

ØxL
mm
6,35x80

1 004500253

450PR

extension for holesaws



L
mm
305

1 004500255

450/C9

assortment of holesaws and accessories for electricians



HSS-Co 8%

450/C9

1 004500305

450 Ø 22 - 29 - 35 - 44 - 51 - 64 mm
450AL /1 - /2
450AD
220x160x60 mm - 1,6 Kg

450/C13

assortment of holesaws and accessories for installers



HSS-Co 8%

450/C13

1 004500310

450 Ø 19 - 22 - 29 - 35 - 38
44 - 51 - 57 - 64 mm

450AL /1 - /2

450PA/1

450AD

215x180x65 mm - 1,8 Kg

450/C21

assortment of holesaws and accessories for industrial use



HSS-Co 8%

450/C21

1 004500315

450 Ø 19 - 22 - 29 - 35 - 38
44 - 51 - 57 - 64 - 76
83 - 92 - 95 - 105 - 114 mm

450AL /1 - /2

450PA /1 - /2

450PR

450AD

420x280x60 mm - 7 Kg

451

hole cutters HSS, entirely ground

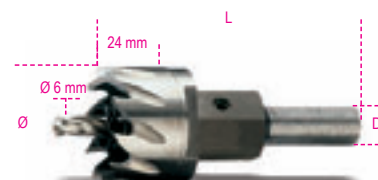

Ø mm	L mm	D mm	
12	85	8	1 004510012
13	85	8	1 004510013
14	85	8	1 004510014
15	85	10	1 004510015
16	85	10	1 004510016
17	85	10	1 004510017
18	85	10	1 004510018
19	85	10	1 004510019
20	85	10	1 004510020
21	85	10	1 004510021
22	85	10	1 004510022
23	85	10	1 004510023
24	85	10	1 004510024
25	85	10	1 004510025
26	90	10	1 004510026
27	90	10	1 004510027
28	90	10	1 004510028
29	90	10	1 004510029
30	90	10	1 004510030
31	90	10	1 004510031
32	90	10	1 004510032
33	90	10	1 004510033
34	90	10	1 004510034
35	90	10	1 004510035
36	85	10	1 004510036
37	85	10	1 004510037
38	85	10	1 004510038
39	85	10	1 004510039
40	85	10	1 004510040
41	85	10	1 004510041
42	85	10	1 004510042
43	85	10	1 004510043
44	85	10	1 004510044
45	85	10	1 004510045
46	85	10	1 004510046
47	85	10	1 004510047
48	85	10	1 004510048
49	85	10	1 004510049
50	85	10	1 004510050

451GA

arbors for hole cutters item 451



M	Ø mm	L mm	D mm	
10x1,25	12÷14	57	8	1 004510101
12x1,25	15÷34	57	10	1 004510102
14x1,5	35÷50	57	10	1 004510105

451PA

pilot drill for hole cutters item 451
HSS



Ø
mm
6

L
mm
53

1 004510103

451PR

extension for hole cutters item 451



M	Ø mm	L mm	Ø1 mm		
12x1,25	15÷34	400	13	1	004510104
14x1,5	35÷50	400	13	1	004510108

452

hole cutters with hard metal insets

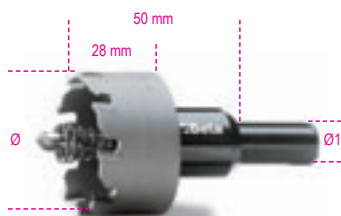

Ø mm	Ø1 mm		
15	10	1	004520015
16	10	1	004520016
17	10	1	004520017
18	10	1	004520018
19	10	1	004520019
20	10	1	004520020
21	10	1	004520021
22	10	1	004520022
23	10	1	004520023
24	10	1	004520024
25	10	1	004520025
26	10	1	004520026
27	10	1	004520027
28	10	1	004520028
29	10	1	004520029
30	10	1	004520030
31	10	1	004520031
32	10	1	004520032
33	10	1	004520033
34	10	1	004520034
35	10	1	004520035
36	10	1	004520036
37	10	1	004520037
38	10	1	004520038
39	13	1	004520039
40	13	1	004520040
41	13	1	004520041
42	13	1	004520042
43	13	1	004520043
44	13	1	004520044
45	13	1	004520045
46	13	1	004520046
47	13	1	004520047
48	13	1	004520048
49	13	1	004520049
50	13	1	004520050
55	13	1	004520055
60	13	1	004520060
65	13	1	004520065
70	13	1	004520070
75	13	1	004520075
80	13	1	004520080
85	13	1	004520085
90	13	1	004520090

452GA

arbors for hole cutters item 452



	Ø mm		
452GA/1	15÷21	1	004520125
452GA/2	22÷38	1	004520126
452GA/3	39÷100	1	004520127

560/C2

torque multiplier, ratio 5:1,
and accessories in plastic case

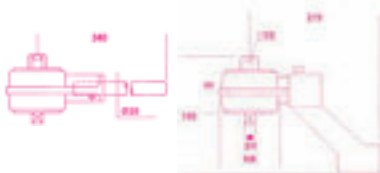
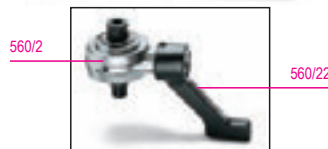

Nm	Kgfm	lbf.ft	□	■	kg
1300	130	960	1/2	3/4	3,8

560/C2	1	005600020
560/2	1	005600002
560/18	1	005600018
560/19	1	005600019
560/22	1	005600022

310x275x120 mm

560/C4+

Torque multiplier,
ratio 5:1,
with reaction foot

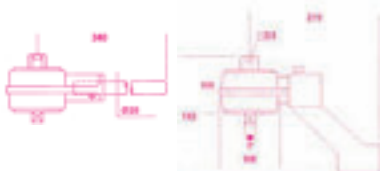
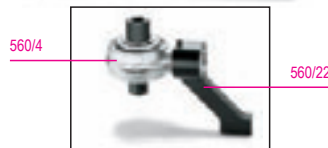

Nm	Kgfm	lbf.ft	□	■	kg
2700	270	2000	3/4	1"	5

560/C4PLUS	1	005600042
560/4	1	005600004
560/18	1	005600018
560/22	1	005600022

310x275x120 mm

560/C6

torque multipliers for right-hand and left-hand
tightening in plastic case
ratio: 6.5:1



Nm	kgfm	lbf.ft	□	■	kg
1500	150	1106	1/2"	3/4"	6

560/C6	1	005600160
--------	---	-----------

400x260x110 mm

560/C12

torque multipliers for right-hand and left-hand
tightening in plastic case
ratio: 12:1



Nm	kgfm	lbf.ft	□	■	kg
2500	250	1844	1/2"	1"	7

560/C12	1	005600210
---------	---	-----------

400x260x110 mm

561/1

torque multiplier,
ratio 5:1
with two reaction feet

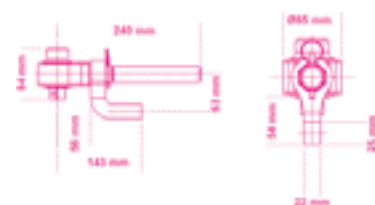

Nm	kgfm	lbf.ft	□	■	kg
1000	100	740	1/2"	3/4"	2,7

561/1	1	005610010
-------	---	-----------

270x210x70 mm

562/1 - 562/2

torque multipliers, ratio 5:1

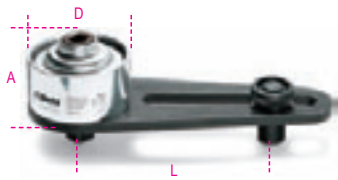

Nm	Kgfm	lbf.ft	□	■	D	A	L min	L max	kg
1700	170	1250	3/4	1"	108	95	85	220	5,3

562/1 1 005620001

Nm	Kgfm	lbf.ft	□	■	D	A	L min	L max	kg
3400	340	2500	3/4	1"	119	115	85	265	7,0

562/2 1 005620002

564/3R - 564/4R

torque multipliers, ratio 25:1, with anti-wind up system



Nm	Kgfm	lbf.ft	□	■	D	A	L	kg
3000	300	2200	1/2	1"	108	188	155	9,2

564/3R 1 005640003

Nm	Kgfm	lbf.ft	□	■	D	A	L	kg
6000	600	4500	1/2	1 1/2"	119	235	200	15,5

564/4R 1 005640004

565/1R - 565/2R - 565/3R

torque multipliers, ratio 25:1 with anti-wind up system



Nm	Kgfm	lbf.ft	□	■	D	A	L min	L max	kg
1700	170	1250	1/2	1"	108	125	80	215	7,7

565/1R 1 005650011

Nm	Kgfm	lbf.ft	□	■	D	A	L min	L max	kg
3400	340	2500	1/2	1"	119	145	85	265	10,1

565/2R 1 005650012

Nm	Kgfm	lbf.ft	□	■	D	A	L min	L max	kg
3400	340	2500	1/2	1 1/2"	119	145	85	265	10,7

565/3R 1 005650013

565/4R

torque multiplier, ratio 25:1 with anti-wind up system

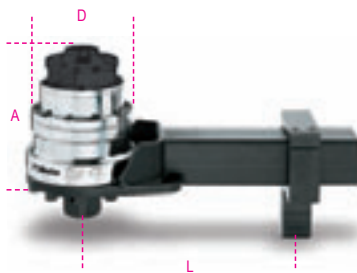

Nm	Kgfm	lbf.ft	□	■	D	A	L min	L max	kg
6000	600	4500	1/2	1 1/2"	144	180	125	335	17

565/4R 1 005650014

565/5R

torque multiplier, ratio 25:1 with anti-wind up system

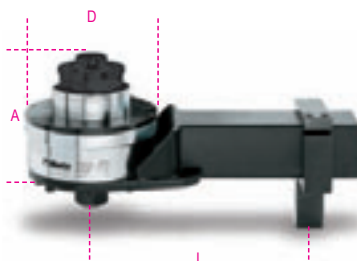

Nm	Kgfm	lbf.ft	□	■	D	A	L min	L max	kg
9500	950	7000	3/4	1 1/2"	184	180	155	355	25

565/5R 1 005650015

567/4R

torque multiplier, ratio 125:1 with anti-wind up system

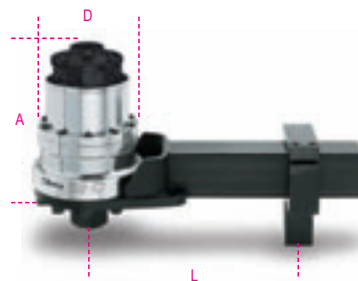

Nm	Kgfm	lbf.ft	□	■	D	A	L min	L max	kg
6000	600	4500	1/2	1 1/2"	144	210	125	335	19

567/4R 1 005670014

567/5R

torque multiplier, ratio 125:1 with anti-wind up system

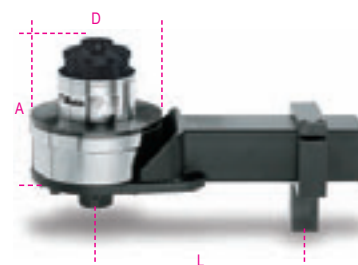

Nm	Kgfm	lbf.ft	□	■	D	A	L min	L max	kg
9500	950	7000	1/2	1 1/2"	184	210	155	350	27

567/5R 1 005670015

581

slip-torque screwdriver, ungraduated for right-hand tightening torque accuracy: ±6% (to be used with items 588 - 682)



UNI EN 26789
ISO 6789

Nm	gfm	□	g
1,2÷6	120÷600	1/4"	275

581 1 005810001

583

slip-torque screwdriver, graduated for right-hand tightening
torque accuracy: $\pm 6\%$



UNI EN 26789
ISO 6789

Nm 0,3÷1,5 Kgf·m 30÷150 O 1/4" g 240

583/1,5 1 005830015

Nm 0,6÷3 Kgf·m 60÷300 O 1/4" g 240

583/3 1 005830030

Nm 1,2÷6 Kgf·m 120÷600 O 1/4" g 350

583/6 1 005830060

588

electronic digital torque meter

For testing and setting torque screwdrivers 581-583
Reading accuracy: $\pm 1\%$ of read value

CE



Nm 1÷10 lbf.in 10÷90 O 1/4" kg 1,8

588 1 005880001

Table of fields of use
for torque wrenches and bars
at end of price list

590 - 592

direct reading torque wrenches
for right-hand and left-hand tightening
torque accuracy: $\pm 4\%$



UNI EN 26789
ISO 6789

Nm 0,3÷4 Kgf·m 0,03÷0,4 lbf.in 3÷35 O 1/4" A mm 60 L mm 253 kg 0,52

590 1 005900001

Nm 0,5÷13,5 Kgf·m 0,05÷1,35 lbf.in 4÷120 O 1/4" A mm 60 L mm 253 kg 0,52

590/1 1 005900003

Nm 1÷27 Kgf·m 0,1÷2,7 lbf.in 10÷240 O 3/8" A mm 70 L mm 253 kg 0,52

592/3 1 005920005

Nm 3÷40 Kgf·m 0,3÷4 lbf.in 20÷360 O 3/8" A mm 70 L mm 253 kg 0,52

592/4 1 005920007

Beta

594

direct reading torque wrenches
for right-hand and left-hand tightening
torque accuracy: $\pm 4\%$

12"

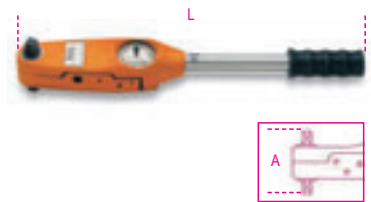

UNI EN 26789
ISO 6789

Nm 6÷80 Kgf·m 0,6÷8 lbf.ft 5÷60 O 1/2" A mm 85 L mm 455 kg 1,35

594/8 1 005940011

Nm 20÷215 Kgf·m 2÷21,5 lbf.ft 15÷160 O 1/2" A mm 85 L mm 530 kg 1,40

594/21 1 005940015

Torque calibration
service
at end of price list

596 - 598

direct reading torque wrenches
for right-hand and left-hand tightening
torque accuracy: $\pm 4\%$

A signal light and an intermittent sound mean the pre-set torque load is achieved.



UNI EN 26789
ISO 6789

Nm 80÷400 Kgf·m 8÷40 lbf.ft 60÷300 O 3/4" A mm 111 L mm 710 kg 3,2

596/40SL 1 005960010

Nm 40÷800 Kgf·m 4÷80 lbf.ft 20÷600 O 3/4" A mm 115 L mm 1025 kg 4,85

596/80SL 1 005960020

Nm 200÷2000 Kgf·m 20÷200 lbf.ft 150÷1500 O 1" A mm 135 L mm 1930 kg 16,70

598/200SL 1 005980022

583/C31

1 torque screwdriver, 8 hexagon hand sockets, 20 bits and 2 accessories

1/4"



583/C31 1 005830931

- 583/6 1.2 - 6 Nm
- 900 4.5-5.5-6.7-8-9-10 mm
- 860LP 0,6x4,5 - 1x5,5 - 1,2x6,5 mm
- 860PH PH1 - PH2 (x2) - PH3
- 860PE 2-2,5-3-4-5 mm
- 860TX T9-T10-T15-T20-T25-T27-T30-T40
- 882P/80 80 mm
- 892/0 ● 1/4 ■ 1/4

270x120x45 mm - 1,2 kg

599DGT

electronic torque wrench with reversible ratchet, right-hand (accuracy: $\pm 2\%$) and left-hand (accuracy: $\pm 3\%$) tightening

- Dual measurement mode: peak hold and track
- Light indicators and an intermittent sound inform user that preset torque has been reached
- Power supply: 2 1.5V batteries (included)



CE



UNI EN 26789
ISO 6789

Nm	Kgfm	lbf.ft	■	D	A	L	■
12÷60	1,2÷6	8÷44	3/8	30	33	413	0,9

599DGT/6 1 005990003

Nm	Kgfm	lbf.ft	■	D	A	L	■
20÷100	2÷10	15÷80	1/2	30	37	413	0,9

599DGT/10X 1 005990010

Nm	Kgfm	lbf.ft	■	D	A	L	■
40÷200	4÷20	30÷150	1/2	40	43	520	2

599DGT/20 1 005990020

Nm	Kgfm	lbf.ft	■	D	A	L	■
68÷340	6,8÷34	58÷280	1/2	40	43	539	2,35

599DGT/30 1 005990030

599DGT-A

electronic torque wrench, torque and angle readout right-hand (accuracy: $\pm 2\%$) and left-hand (accuracy: $\pm 3\%$) tightening in plastic case

- Tightening strategy: torque + angle
- Internal data storage software: up to 9 torque/angle values can be preset
- Software and USB cable for downloading data
- Dual measurement mode: peak hold and track
- Light indicators and an intermittent sound inform user that preset torque or angle has been reached
- Non-slip bi-material handle
- Power supply: 2 AA - 1.5V batteries (included)



12"

CE



UNI EN 26789
ISO 6789

Nm	Kgfm	lbf.ft	■	D	A	L	■
20÷100	2÷10	15÷80	1/2	30	33	413	0,9

599DGT-A/10 1 005990510

Nm	Kgfm	lbf.ft	■	D	A	L	■
40÷200	4÷20	30÷150	1/2	40	43	520	1,3

599DGT-A/20 1 005990520

Torque calibration service at end of price list

600

torque angle indicators

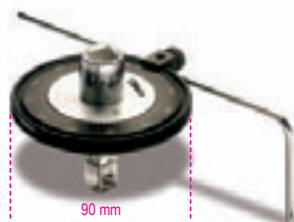

	□	■	■	■	■	■	■
600/1	1/2	1/2					1 006000001
600/2	3/4	3/4					1 006000002

601C

digital torque indicator

Light signals and an intermittent sound inform user that preset angle has been reached

CE



601C 1 006010100

85x80x87 mm - 70 g

601CA

digital torque and angle indicator

light indicators and an intermittent sound inform user that preset torque or angle has been reached

12"

CE



601CA Nm 1/2" 1/2" 10÷200 1 006010120

120x90x120 mm - 240 g

603

calibrated slipping torque wrenches for right-hand tightening torque accuracy: $\pm 6\%$

14"



UNI EN 26789
ISO 6789

Nm	Kgfm	lbf.in	■	A	L	■
1÷5	0,1÷0,5	10÷45	1/4	35	195	235

603/5 1 006030005

Nm	Kgfm	lbf.in	■	A	L	■
2÷10	0,2÷1,0	18÷90	1/4	35	195	235

603/10 1 006030010

604B

break-back torque bars
for right-hand and left-hand tightening
torque accuracy: $\pm 6\%$



UNI EN 26789
ISO 6789

Nm	Kgfm	lbf.in	Ø mm	L mm	g
1÷5	0,1÷0,5	10÷45	8	220	290

604B/5	1	006040015
--------	---	-----------

Nm	Kgfm	lbf.in	Ø mm	L mm	g
2÷10	0,2÷1,0	18÷90	8	220	300

604B/10	1	006040020
---------	---	-----------

605E

click-type torque wrenches
with reversible ratchets
for right-hand and left-hand tightening
torque accuracy: $\pm 6\%$



UNI EN 26789
ISO 6789

Nm	Kgfm	lbf.in	1/4	A mm	L mm	g
1÷5	0,1÷0,5	10÷45	1/4	20	190	180

605E/5	1	006050105
--------	---	-----------

Nm	Kgfm	lbf.in	1/4	A mm	L mm	g
2÷10	0,2÷1,0	18÷90	1/4	20	190	180

605E/10	1	006050110
---------	---	-----------

606/6 ÷ 606/30

click-type torque wrenches
with reversible ratchets
for right-hand tightening
torque accuracy: $\pm 4\%$



UNI EN 26789
ISO 6789

Nm	Kgfm	lbf.ft	3/8	D mm	A mm	L mm	g
8÷60	0,8÷6	6÷44	3/8	30	33	305	595

606/6	1	006060105
-------	---	-----------

Nm	Kgfm	lbf.ft	3/8	D mm	A mm	L mm	g
20÷100	2÷10	15÷80	3/8	30	33	345	660

606/10	1	006060110
--------	---	-----------

Nm	Kgfm	lbf.ft	1/2	D mm	A mm	L mm	g
20÷100	2÷10	15÷80	1/2	30	37	345	680

606/10X	1	006060111
---------	---	-----------

Nm	Kgfm	lbf.ft	1/2	D mm	A mm	L mm	g
40÷200	4÷20	30÷150	1/2	40	43	440	920

606/20	1	006060120
--------	---	-----------

Nm	Kgfm	lbf.ft	1/2	D mm	A mm	L mm	g
60÷330	6÷33	40÷250	1/2	40	43	560	1180

606/30	1	006060130
--------	---	-----------

611

reversible ratchets
for torque bars items 604B/5 and 604B/10
8 mm drive



1/4	L mm	1	006110001
1/4	42,5	1	006110001

**Torque calibration
service
at end of price list**

612 ÷ 614

reversible ratchets for torque bars



Items 612 and 612X should not be used
with tightening torques exceeding 100 Nm

612	3/8	L mm	LA mm	2	006120000
612	3/8	66	32	2	006120000
612X	1/2	66	32	2	006120010
614	1/2	71	32	2	006140000
614X	3/4	71	32	2	006140004

614/50

push-through ratchet for torque bars



614/50	1/2	L mm	LA mm	2	006140002
614/50	1/2	71	32	2	006140002

**Spare parts
rotating mechanism of ratchets,
see table after item 929/C8**

615

reversible ratchets
for torque bars, rectangular drive



mm	3/8	L mm	LA mm	1	006150010
9x12	3/8	53	28,8	1	006150010
9x12	1/2	53	28,8	1	006150020
14x18	1/2	70	39,8	1	006150120

616 - 617 - 619

fixed heads for torque bars



616	1/4	L mm	LA mm	1	006160000
616	1/4	61	32	1	006160000
617	3/8	61	32	1	006170000
619	1/2	63	32	1	006190000

621

bit holder accessories
for torque bars, rectangular drive



P 1/4	9x12	1/4	L mm	LA mm	1	006210000
P 1/4	9x12	1/4	40	28,8	1	006210000
* P 5/16	14x18	5/16	61	32,5	1	006210110

*Caution! Recalculate torque value to set as shown in
table at end of price list

666N LBF.IN

click-type torque wrenches with reversible ratchets, for right-hand tightening torque accuracy: $\pm 3\%$

• Scale in pounds force per inch



UNI EN 26789
ISO 6789

lbf.in	■	D mm	A mm	L mm	g
90÷440	3/8	30	33	312	660

666N-LBF.IN/5	1	006660055
----------------------	---	-----------

lbf.in	■	D mm	A mm	L mm	g
200÷800	3/8	30	33	381	730

666N-LBF.IN/10	1	006660070
-----------------------	---	-----------

lbf.in	■	D mm	A mm	L mm	g
200÷800	1/2	30	37	387	800

666N-LBF.IN/10X	1	006660071
------------------------	---	-----------

lbf.in	■	D mm	A mm	L mm	g
400÷1800	1/2	40	43	470	1010

666N-LBF.IN/20	1	006660072
-----------------------	---	-----------

lbf.in	■	D mm	A mm	L mm	g
500÷3000	1/2	40	43	598	1380

666N-LBF.IN/30	1	006660073
-----------------------	---	-----------

667N

click-type torque wrenches with push-through ratchets, for right-hand and left-hand tightening, torque accuracy: $\pm 3\%$



UNI EN 26789
ISO 6789

Nm	Kgfm	lbf.ft	■	D mm	A mm	L mm	g
40÷200	4÷20	30÷150	1/2	40	43	470	1010

667N/20	1	006670020
----------------	---	-----------

Nm	Kgfm	lbf.ft	■	D mm	A mm	L mm	g
60÷300	6÷30	50÷220	1/2	40	43	598	1380

667N/30	1	006670030
----------------	---	-----------

Nm	Kgfm	lbf.ft	■	D mm	A mm	L mm	g
80÷400	8÷40	60÷295	3/4	50	50	711	2090

667N/40	1	006670040
----------------	---	-----------

Spare parts
rotating mechanism of ratchets,
see table after item 929/C8

668N

click-type torque bars, for right-hand and left-hand tightening, torque accuracy: $\pm 3\%$



UNI EN 26789
ISO 6789

Nm	Kgfm	lbf.ft	Ø mm	L mm	LB mm	LS mm	g
5÷25	0,5÷2,5	4÷18	16	220	148	32	300

668N/2	1	006680002
---------------	---	-----------

Nm	Kgfm	lbf.ft	Ø mm	L mm	LB mm	LS mm	g
10÷50	1÷5	7÷37	16	307	229	32	590

668N/5	1	006680005
---------------	---	-----------

Nm	Kgfm	lbf.ft	Ø mm	L mm	LB mm	LS mm	g
20÷100	2÷10	15÷75	16	376	269	32	670

668N/10	1	006680010
----------------	---	-----------

Nm	Kgfm	lbf.ft	Ø mm	L mm	LB mm	LS mm	g
40÷200	4÷20	30÷150	16	450	352,6	32	795

668N/20	1	006680020
----------------	---	-----------

Nm	Kgfm	lbf.ft	Ø mm	L mm	LB mm	LS mm	g
60÷300	6÷30	50÷220	16	588	475,9	32	1230

668N/30	1	006680030
----------------	---	-----------

668RG

click-type torque bar, ungraduated for right-hand and left-hand tightening torque accuracy: $\pm 4\%$ (to be used with items 680 - 682)



UNI EN 26789
ISO 6789

Nm	Kgfm	lbf.ft	Ø mm	L mm	g
8÷60	0,8÷6	6÷44	16	288	550

668RG/6	1	006680206
----------------	---	-----------

Nm	Kgfm	lbf.ft	Ø mm	L mm	g
20÷100	2÷10	15÷80	16	315	600

668RG/10	1	006680210
-----------------	---	-----------

Nm	Kgfm	lbf.ft	Ø mm	L mm	g
40÷200	4÷20	30÷150	16	405	780

668RG/20	1	006680220
-----------------	---	-----------

Nm	Kgfm	lbf.ft	Ø mm	L mm	g
60÷300	6÷30	50÷220	16	645	1130

668RG/30	1	006680230
-----------------	---	-----------

 **Beta**

 **Beta**

669N

click-type torque bars,
rectangular drive,
for right-hand and left-hand tightening,
torque accuracy: $\pm 3\%$

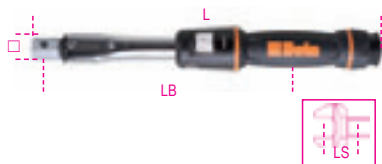

UNI EN 26789
ISO 6789

Nm	Kgfm	lbf.ft	□ mm	L mm	LB mm	LS mm	g
5÷25	0,5÷2,5	4÷18	9x12	215	140	28,8	300

669N/2 1 006690202

Nm	Kgfm	lbf.ft	□ mm	L mm	LB mm	LS mm	g
10÷50	1÷5	7÷37	9x12	307	226,8	28,8	590

669N/5 1 006690205

Nm	Kgfm	lbf.ft	□ mm	L mm	LB mm	LS mm	g
20÷100	2÷10	15÷75	9x12	376	266,8	28,8	670

669N/10 1 006690210

Nm	Kgfm	lbf.ft	□ mm	L mm	LB mm	LS mm	g
40÷200	4÷20	30÷150	9x12	450	345,6	28,8	795

669N/20 1 006690220

Nm	Kgfm	lbf.ft	□ mm	L mm	LB mm	LS mm	g
40÷200	4÷20	30÷150	14x18	450	351	39,8	795

669N/20X 1 006690221

Nm	Kgfm	lbf.ft	□ mm	L mm	LB mm	LS mm	g
60÷300	6÷30	50÷220	14x18	588	468,5	39,8	1230

669N/30 1 006690230

671B/C5

torque bar item 604B/5 and accessories



671B/C5 1 006710001

604B/5	1÷5 Nm
611	1/4
641	5-6-7-8 mm
900	4-5-5,5-6-7-8-9-10 mm

270x120x45 mm - 1,3 kg

671B/C10

torque bar item 604B/10 and accessories



671B/C10 1 006710002

604B/10	2÷10 Nm
611	1/4
641	6-7-8-10 mm
900	4-5-5,5-6-7-8-9-10 mm

270x120x45 mm - 1,4 kg

671N/C10

torque bar 668N/10
and accessories



671N/C10 1 006710110

668N/10	100 Nm
612	■ 3/8
617	■ 3/8
642	10-13-14-17-19 mm
652	10-13-14-17-19 mm
910A	□ 3/8 8-10-11-13-14-17-19 mm
910/21	125 mm
910/22	250 mm

400x180x45 mm - 4,3 kg

671N/C20

torque bar 668N/20
and accessories



671N/C20 1 006710120

668N/20	200 Nm
614	■ 1/2
619	■ 1/2
642	10-13-14-17-19 mm
652	10-13-14-17-19 mm
920A	□ 1/2 10-11-13-14-17-19-22 mm
920/20	75 mm
920/21	125 mm
920/22	255 mm

510x180x45 mm - 5,5 kg

671N/C30

torque bar 668N/30
and accessories



671N/C30 1 006710130

668N/30	300 Nm
614	■ 1/2
619	■ 1/2
642	13-14-17-19 mm
652	13-14-17-19 mm
920A	□ 1/2 13-14-17-19-22-24-27 mm
920/20	75 mm
920/21	125 mm
920/22	255 mm

620x180x45 mm - 5,8 kg

677

break-back torque wrenches
with push-through ratchets
for right-hand and left-hand tightening
torque accuracy: $\pm 4\%$



UNI EN 26789
ISO 6789

Nm	Kgfm	lbf.ft	D mm	A mm	L mm	kg
100÷500	10÷50	70÷350	70	55	915	5,2

677/50 1 006770050

Nm	Kgfm	lbf.ft	D mm	A mm	L mm	kg
150÷700	15÷70	100÷500	70	55	1140	6,2

677/70 1 006770070

Nm	Kgfm	lbf.ft	D mm	A mm	L mm	kg
300÷1000	30÷100	200÷750	70	55	1470	7,5

677/100 1 006770100



677/C

break-back torque wrenches with push-through ratchets, for right-hand and left-hand tightening, torque accuracy: $\pm 4\%$ in case

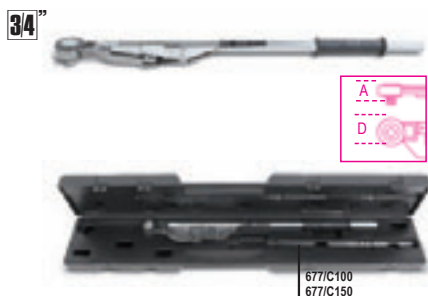

UNI EN 26789
ISO 6789

Nm	Kgfm	lbf.ft	D mm	A mm	L mm	kg
100÷500	10÷50	70÷350	70	55	915	5,2

677/C50 1 006770606

Nm	Kgfm	lbf.ft	D mm	A mm	L mm	kg
150÷700	15÷70	100÷500	70	55	1140	6,2

677/C70 1 006770611

Nm	Kgfm	lbf.ft	D mm	A mm	L mm	kg
300÷1000	30÷100	200÷750	70	55	1470	7,5

677/C100 1 006770615

Nm	Kgfm	lbf.ft	D mm	A mm	L mm	kg
700÷1500	70÷150	500÷1000	70	70	1475	10,4

677/C150 1 006770620

677/CP200

break-back torque wrenches with push-through ratchets for right-hand and left-hand tightening torque accuracy: $\pm 4\%$ in case



UNI EN 26789
ISO 6789

Nm	kgfm	lbf.in	D mm	A mm	L mm	kg
900÷2000	90÷200	600÷1500	70	63	1920	13

677/CP200 1 006770720

Torque calibration service at end of price list

678/C

click-type torque wrenches with push-through ratchets for right-hand and left-hand tightening torque accuracy: $\pm 4\%$ in case



Nm	Kgfm	lbf.ft	D mm	A mm	L mm	kg
130÷650	13÷65	100÷480	63	55	885	3,9

678/C65 1 006780607

Nm	Kgfm	lbf.ft	D mm	A mm	L mm	kg
300÷1000	30÷100	220÷750	75	60	1250	6,0

678/C100 1 006780611

Nm	Kgfm	lbf.ft	D mm	A mm	L mm	kg
500÷1500	50÷150	370÷1100	75	60	1570	8,5

678/C150 1 006780615

677/CV - 678/CV

empty cases for torque wrenches items 677 and 678



677/CV1 1 006770450

677/C50-677/C70

678/CV2 1 006780500

678/C100

678/CV3 1 006780415

677/C100-677/C150-678/C150

Beta

680

electronic digital torque meter Dynatester 680 for checking calibration, can be used both clockwise and anticlockwise

- Accuracy: $\pm 1\%$
- 3 measuring units: Nm - lbf.ft. - lbf.in



	Nm	kg		
680/2,5	1÷25	2,6	1	006800002
680/40	15÷400	4,0	1	006800040
680/100	100÷1000	4,8	1	006800100

682

electronic digital torque meter with transducer Dynatester 682 to be used either clockwise or anticlockwise Remarkable reading accuracy Supplied with serial output RS 232 for printers



TECHNICAL FEATURES
Reading accuracy $\pm 1\%$ of the read value
Available measuring units
Nm-dNm-cNm-Lbf.ft-Lbf.in-Oz.f.in-Kgf.m-Kgf.cm-gf.cm
Supply range 90 to 264 V AC at 50/60 Hz
Dimensions 235x185x185 mm
Tolerance test according to norm ISO 6789
Acceptability range for each torque wrench tested
Display
Menu available in 11 languages
Provided with all certificates required
Calibration certificate with UKAS traceability

	Nm	kg		
682/60	1,2÷60	5,9	1	006820006
682/400	8÷400	6,1	1	006820040
682/1500	30÷1500	6,4	1	006820150

710

impact sockets, standard series



UNI/ISO 2725 DIN 3129

mm	Ø	L	Ø1		
7	12,5	28	19	3	007100007
8	13,8	28	19	3	007100008
9	15,0	28	19	3	007100009
10	16,3	28	19	3	007100010
11	17,5	30	19	3	007100011
12	19,0	30	19	3	007100012
13	20,0	30	22	3	007100013
14	21,3	30	22	3	007100014
16	23,8	30	22	3	007100016
17	25,0	30	22	3	007100017
18	26,3	30	22	3	007100018
19	27,5	30	22	3	007100019
21	30,0	32	22	3	007100021
22	32,0	32	22	3	007100022

710/16

impact adaptor, 3/8" female and 1/2" male drives



L	Ø				
32	22	3/8	1/2	3	007100810

710/20

3/8" drive impact extension bar



L	Ø				
75	22			2	007100821

710/21

3/8" drive impact extension bar



L	Ø				
125	22			2	007100823

710/25

3/8" drive impact universal joint



L	Ø				
58	24			2	007100830

710/C10

10 impact sockets



710/C10

7-8-10-11-12-13
14-17-19-22 mm

1 007100910

130x55x40 mm - 800 g

710/OR... - 710/SP...

rubber O-rings and locking pins for impact sockets



	710	710/16		
710/OR1	7+12		10	007100921
710/OR2	13+22	32	10	007100922
710/SP1	7+12		10	007100911
710/SP2	13+22	32	10	007100912

720

impact sockets, standard series



UNI/ISO 2725 DIN 3129

mm	Ø	L	Ø1		
10	17,0	38	25	5	007200010
11	18,5	38	25	5	007200011
12	20,0	38	25	5	007200012
13	21,0	38	25	5	007200013
14	22,5	38	25	5	007200014
15	23,0	38	30	5	007200015
16	25,0	38	30	5	007200016
17	26,0	38	30	5	007200017
18	27,5	38	30	5	007200018
19	28,5	38	30	5	007200019
21	31,0	38	30	5	007200021
22	32,5	38	30	5	007200022
23	34,0	38	30	5	007200023

mm	Ø	L	Ø1		
24	35,0	38	30	5	007200024
27	38,5	45	30	3	007200027
30	42,0	50	30	3	007200030
32	44,0	50	30	3	007200032
36	50,0	50	30	3	007200036

720AS

impact sockets, standard series



"	Ø	L	Ø1		
3/8	17,0	38	25	2	007200210
7/16	18,2	38	25	2	007200211
1/2	20,7	38	25	2	007200213
9/16	22,0	38	25	2	007200214
5/8	24,5	38	30	2	007200216
11/16	25,7	38	30	2	007200217
3/4	28,2	38	30	2	007200219
13/16	30,7	38	30	2	007200221
7/8	32,0	38	30	2	007200222
15/16	34,5	38	30	2	007200224
1	35,7	38	30	2	007200225
1.1/16	38,2	40	30	1	007200227
1.1/8	40,7	42	30	1	007200229
1.1/4	44,5	42	30	1	007200232

720L

impact sockets, long series



UNI/ISO 2725

mm	Ø	L	Ø1		
10	17,0	80	25	2	007200310
11	18,5	80	25	2	007200311
12	20,0	80	25	2	007200312
13	21,0	80	25	2	007200313
14	22,5	80	25	2	007200314
15	23,0	80	30	2	007200315
16	25,0	80	30	2	007200316
17	26,0	80	30	2	007200317
18	27,5	80	30	2	007200318
19	28,5	80	30	2	007200319
21	31,0	80	30	2	007200321
22	32,5	80	30	2	007200322
24	35,0	80	30	2	007200324
27	38,5	80	30	2	007200327
30	42,0	80	30	2	007200330
32	44,0	80	30	2	007200332
36	50,0	80	30	2	007200336

720L/S3

set of 3 impact sockets item 720L



mm					
17-19-21				1	007200355

720LS

impact sockets, long, slim series



UNI/ISO 2725

mm	Ø	L	Ø1		
mm	mm	mm	mm		
10	15,5	78	24	2	007200360
11	16,7	78	24	2	007200361
12	18,0	78	24	2	007200362
13	19,2	78	24	2	007200363
14	20,5	78	24	2	007200364
15	21,7	78	24	2	007200365
16	23,0	78	24	2	007200366
17	24,2	78	29	2	007200367
18	25,5	78	29	2	007200368
19	26,7	78	29	2	007200369
21	29,2	78	29	2	007200371
22	30,5	78	29	2	007200372
24	33,0	78	29	2	007200374
27	36,7	78	29	2	007200377
30	40,5	78	29	2	007200380
32	43,0	78	29	2	007200382
36	48,0	78	29	2	007200386

720FTX

impact sockets, for Torx® head screws



mm	Ø	L	Ø1		
mm	mm	mm	mm		
E10	14,0	38	25	2	007200410
E12	15,9	38	25	2	007200412
E14	17,7	38	25	2	007200414
E16	20,0	38	25	2	007200416
E18	22,0	38	25	2	007200418
E20	25,0	40	25	2	007200420



720FTX/SB6
E10-E12-E14
E16-E18-E20
1 007200450

720TX

impact socket drivers for Torx® head screws



mm	Ø	L	L1		
mm	mm	mm	mm		
T30	25	78	54	3	007200460
T40	25	78	54	3	007200470
T45	25	78	54	3	007200472
T50	25	78	54	3	007200474
T55	25	78	54	3	007200476
T60	25	78	54	3	007200478

720TX/C6

6 impact socket drivers for Torx® head screws



720TX/C6
T30-T40-T45
T50-T55-T60
1 007200483

275x120x65 mm - 5700 g

720ME

impact socket drivers for hexagon screws



mm	Ø	L	L1		
mm	mm	mm	mm		
5	25	78	54	3	007200505
6	25	78	54	3	007200506
8	25	78	54	3	007200508
10	25	78	54	3	007200510
12	25	78	54	3	007200512
14	25	78	54	3	007200514
17	25	78	54	3	007200517
19	25	78	54	3	007200519

720ME/C8

8 impact socket drivers for hexagon screws



720ME/C8
5-6-8-10-12
14-17-19 mm
1 007200525

270x120x45 mm - 1710 g

720/15

impact adaptor, 1/2" female and 3/8" male drives



mm	Ø				
mm	mm				
37,5	25	1/2	3/8	3	007200810



Always apply torque loads evenly and progressively to avoid breakage and any possible injury.

720/16

impact adaptor, 1/2" female and 3/4" male drives



mm	Ø				
mm	mm				
44	30	1/2	3/4	3	007200814

720/20

1/2" drive impact extension bar



mm	Ø				
mm	mm				
75	25			3	007200818

720/21

1/2" drive impact extension bar



mm	Ø				
mm	mm				
125	25			3	007200822

720/25

1/2" drive impact universal joint



mm	Ø				
mm	mm				
64	28			2	007200831

Beta

720/C6

6 impact sockets

12"



720/C6
13-14-17-19-22-24 mm

195x80x55 mm - 1100 g

720/C12

12 impact sockets

12"



720/C12
10-11-12-13-14-17
19-22-24-27-30-32 mm

195x80x55 mm - 2000 g

720/OR... - 720/SP...

rubber O-rings and locking pins for impact sockets

12"

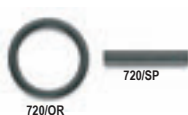

	720	720TX		
	mm	mm		
720/OR1	10÷14	T30÷T60	10	007200923
720/OR2	15÷32		10	007200924
720/SP1	10÷14	T30÷T60	10	007200913
720/SP2	15÷32		10	007200914

727PI/16

impact bit holder for item 727/ES16 and 727/ES16TX

3/4"



∅	L	∅		
mm	mm	mm		
44	52	16	3/4	2 007270016

727/ES16

impact hexagon bits, 16 mm drive



mm	mm	L		
mm	mm	mm		
10	16	40	2	007270110
12	16	40	2	007270112
13	16	40	2	007270113
14	16	40	2	007270114
16	16	40	2	007270116
17	16	40	2	007270117
18	16	40	2	007270118
19	16	40	2	007270119
22	16	40	2	007270122

727/ES16TX

impact bits for Torx® head screws, 16 mm drive



	mm	L		
	mm	mm		
T55	16	50	2	007270355
T60	16	50	2	007270360
T70	16	50	2	007270370

727PI/22

impact bit holder for item 727/ES22 and 727/ES22TX



1"



∅	L	∅		
mm	mm	mm		
54	70	22	2	007270022

727/ES22

impact hexagon bits, 22 mm drive



mm	mm	L		
mm	mm	mm		
19	22	50	2	007270219
22	22	50	2	007270222
24	22	50	2	007270224
27	22	50	2	007270227
30	22	50	2	007270230
32	22	50	2	007270232

727/ES22TX

impact bits for Torx® head screws, 22 mm drive



	mm	L		
	mm	mm		
T80	22	60	2	007270480
T90	22	60	2	007270490
T100	22	60	2	007270500

727/C16

12 impact bits and 4 accessories



3/4"

1"

727/C16 1 007270900

727PI/16
727/ES16 14-17-19 mm
727/ES16TX T55-T60-T70
727PI/22
727/ES22 22-24-27 mm
727/ES22TX T80-T90-T100
96BPC 3-4 mm

335x145x60 mm - 3,6 kg

727PI/32

impact bit holder for item 727/ES32



1 1/2"



∅	L	∅		
mm	mm	mm		
86	66	32	1	007270032

727/ES32

impact hexagon bit, 32 mm drive



mm	mm	L		
mm	mm	mm		
19	32	44	2	007270519
22	32	44	2	007270522
24	32	44	2	007270524
27	32	44	2	007270527
30	32	44	2	007270530
32	32	44	2	007270532
36	32	44	2	007270536

728

impact sockets, standard series



UNI/ISO 2725 DIN 3129

Ø	Ø	L	Ø1		
mm	mm	mm	mm		
17	30,0	51	44	2	007280017
18	31,0	51	44	2	007280018
19	32,5	51	44	2	007280019
21	35,0	51	44	2	007280021
22	36,0	51	44	2	007280022
23	37,5	51	44	2	007280023
24	38,5	51	44	2	007280024
27	42,5	53	44	2	007280027
28	44,0	53	44	2	007280028
30	46,0	53	44	2	007280030
32	48,5	57	44	2	007280032
33	50,0	57	44	2	007280033
34	51,0	57	44	2	007280034
35	52,5	57	44	2	007280035
36	53,5	57	44	2	007280036
38	56,0	57	44	1	007280038
40	58,5	58	44	1	007280040
41	60,0	58	44	1	007280041
44	64,0	62	44	1	007280044
45	65,0	62	44	1	007280045
46	66,0	62	44	1	007280046
50	71,0	68	54	1	007280050
55	77,5	71	54	1	007280055
60	83,0	73	54	1	007280060
65	88,0	78	54	1	007280065

728FTX

impact sockets, for Torx® head screws



Ø	L	Ø1		
mm	mm	mm		
E20	28,5	50	44	2 007280420
E22	30,0	50	44	2 007280422
E24	32,5	50	44	2 007280424

728L

impact sockets, long series



Ø	L	Ø1		
mm	mm	mm		
19	32,5	90	44	2 007280319
21	35,0	90	44	2 007280321
22	36,0	90	44	2 007280322
24	38,5	90	44	2 007280324
26	41,0	90	44	2 007280326
27	42,5	90	44	2 007280327
30	46,0	90	44	2 007280330
32	48,5	90	44	2 007280332
33	50,0	90	44	1 007280333
34	51,0	90	44	1 007280334
36	53,5	90	44	1 007280336
38	56,0	90	44	1 007280338
41	60,0	90	44	1 007280341
46	66,0	90	44	1 007280346
50	71,0	90	44	1 007280350
55	77,5	100	54	1 007280355

728LS

impact sockets, long slim series



Ø	L	Ø1		
mm	mm	mm		
17	28,0	100	43	2 007280517
19	30,5	100	43	2 007280519
22	34,3	100	43	2 007280522
24	36,8	100	43	2 007280524
27	40,5	100	43	2 007280527
30	44,3	100	43	2 007280530
32	46,8	100	43	2 007280532
33	48,0	100	43	2 007280533
36	51,8	100	43	1 007280536

728LQ

impact sockets, long series

(for ISUZU wheel nuts)



L	Ø	Ø1		
mm	mm	mm		
19	90	35	43,5	1 007280619
21	90	42	43,5	1 007280621

728/15

impact adaptor, 3/4" female and 1/2" male drives



L	Ø				
mm	mm	□	■		
58	38	3/4	1/2	2	007280810



Always apply torque loads evenly and progressively to avoid breakage and any possible injury.

728/16

impact adaptor, 3/4" female and 1" male drives



L	Ø				
mm	mm	□	■		
62	44	3/4	1	2	007280813

728/21

3/4" drive impact extension bar



L	Ø		
mm	mm		
175	44	2	007280815

728/22

3/4" drive impact extension bar



L	Ø		
mm	mm		
250	44	2	007280825

728/22L

3/4" drive impact extension bar



L	Ø		
mm	mm		
330	44	1	007280826

728/25

3/4" drive impact universal joint



L	Ø		
mm	mm		
107,5	44	1	007280830

728/C10

10 impact sockets



728/C10	17-19-22-24-27-30	1	007280910
	32-36-41-46 mm		

275x120x65 mm - 5,7 kg

728/OR - 728/SP

rubber O-rings and locking pins for impact sockets

3/4"

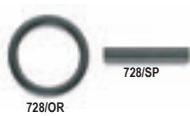

	728 mm	728FTX mm		
728/OR	728/15		5	007280925
728/OR	17+46	E20+E24	10	007280926
728/SP	17+46	E20+E24	10	007280916

729

impact sockets, standard series

1"



UNI/ISO 2725 DIN 3129

mm	Ø mm	L mm	Ø1 mm	
24	41,5	58	54	1 007290024
27	45,0	60	54	1 007290027
30	49,0	62	54	1 007290030
32	51,5	63	54	1 007290032
33	52,5	63	54	1 007290033
34	54,0	63	54	1 007290034
36	56,5	66	54	1 007290036
38	59,0	66	54	1 007290038
41	62,5	68	54	1 007290041
46	69,0	72	54	1 007290046
50	74,0	76	54	1 007290050
55	80,0	84	54	1 007290055
60	86,5	88	54	1 007290060
65	92,5	92	54	1 007290065
70	99,0	96	54	1 007290070
75	105,0	102	63	1 007290075
80	111,5	102	63	1 007290080

729L

impact sockets, long series

1"



mm	Ø mm	L mm	Ø1 mm	
24	41,5	108	54	1 007290324
27	45,0	108	54	1 007290327
30	49,0	108	54	1 007290330
32	51,5	108	54	1 007290332
33	52,2	108	54	1 007290333
34	54,0	108	54	1 007290334
36	56,5	108	54	1 007290336
41	62,5	108	54	1 007290341
46	69,0	108	54	1 007290346
50	74,0	108	54	1 007290350
55	80,0	108	54	1 007290355
60	86,5	108	54	1 007290360
65	92,5	108	54	1 007290365
70	99,0	108	54	1 007290370
75	105,0	108	63	1 007290375
80	111,5	108	63	1 007290380

729LS

impact sockets, long slim series

1"



mm	Ø mm	L mm	Ø1 mm	
22	36,0	108	53	1 007290522
24	38,5	108	53	1 007290524
27	42,3	108	53	1 007290527
30	46,0	108	53	1 007290530
32	48,5	108	53	1 007290532
33	49,8	108	53	1 007290533
36	53,5	108	53	1 007290536

729T

impact torsion bars for wheel nuts

1"



mm	Nm	L mm	
24	350	300	1 007290724
27	450	300	1 007290757
30	500	300	1 007290730
32	450	300	1 007290732
32	600	300	1 007290762
33	600	300	1 007290763
36	600	300	1 007290736

729/15

impact adaptor, 1" female and 3/4" male drives

1"



L mm	Ø mm	□	■	
66,5	54	1	3/4	1 007290810



Always apply torque loads evenly and progressively to avoid breakage and any possible injury.

729/16

impact adaptor, 1" female and 1.1/2" male drives

1"



L mm	Ø mm	□	■	
88	54,0	1	1.1/2	1 007290813

729/21

1" drive impact extension bar

1"



L mm	Ø mm	
175	54	1 007290815

729/22

1" drive impact extension bar

1"



L mm	Ø mm	
330	54	1 007290825

729/25

1" drive impact universal joint

1"



L mm	Ø mm	
130	54	1 007290830

729/OR... - 729/SP...

rubber O-rings and locking pins for impact sockets

3/4"

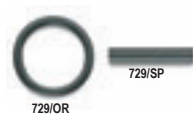

1 1/2"

	728 mm	729-730 mm	
729/OR1	50+60	24+70	5 007290927
729/OR2		75+125	5 007290928
729/SP1	50+60	24+70	5 007290917
729/SP2		75+125	5 007290918

 Beta

 Beta

730

impact sockets, standard series



UNI/ISO 2725 DIN 3129

Ø	Ø	L	Ø1		
mm	mm	mm	mm		
50	81	87	84	1	007300050
55	88	90	86	1	007300055
60	94	95	86	1	007300060
65	100	100	86	1	007300065
70	106	105	86	1	007300070
75	113	110	86	1	007300075
80	119	115	86	1	007300080
85	125	120	86	1	007300085
90	132	125	86	1	007300090
95	138	125	96	1	007300095
100	144	130	96	1	007300100
105	150	135	96	1	007300105
110	157	140	96	1	007300110
115	163	140	96	1	007300115
120	169	145	96	1	007300120
125	175	145	96	1	007300125

730/15

adaptor



L	Ø				
mm	mm				
105	84,0	1.1/2	1	1	007300810

Always apply torque loads evenly and progressively to avoid breakage and any possible injury.

733/15

adaptor

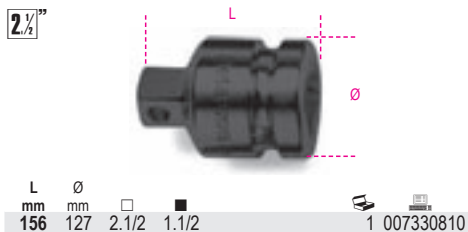

L	Ø				
mm	mm				
156	127	2.1/2	1.1/2	1	007330810

851

magnetic bit holder with handle

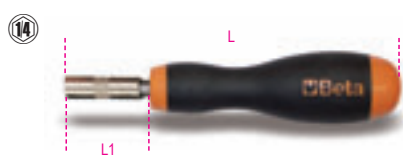

L1	L		
mm	mm		
45	165	2	008510165
125	245	2	008510245

851SR

quick release bit holder with handle



L	L1		
mm	mm		
230	110	2	008510001

852

bit holder with articulated T handle

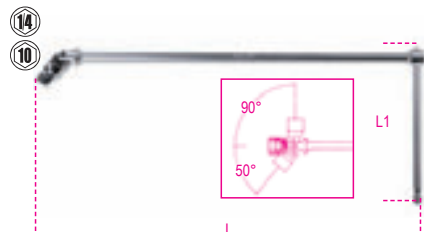

	L	L1		
	mm	mm		
1/4"	400	160	2	008520006
10 mm	400	160	2	008520010

855P

reversible ratchet bit holder with articulated handle, and 7 built-in bits

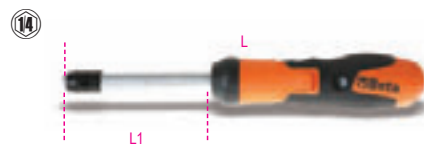

L	L1		
mm	mm		
240	100	1	008550010

- 860PH PH1 - PH2
- 860PZ PZ1 - PZ2
- 860LP LP 0,8X5,5 mm
- 860PE 4 - 5 mm

860LP

bits for slotted head screws, coloured



ISO 2351-1
ISO 1173 C 6,3

SxA	L		
mm	mm		
0,5x3	25	5	008600005
0,6x4,5	25	5	008600010
0,8x5,5	25	5	008600015
1x5,5	25	5	008600020
1,2x6,5	25	5	008600025

860PH

bits for cross head Phillips® screws, coloured



ISO 2351-2
ISO 1173 C 6,3

PH	L		
	mm		
0	25	5	008600220
1	25	5	008600225
2	25	5	008600230
3	25	5	008600245
4	25	5	008600250

860PZ

bits for cross head Pozidriv® - Supadriv® screws, coloured



ISO 2351-2
ISO 1173 C 6,3

PZ	L		
	mm		
1	25	5	008600320
2	25	5	008600325
3	25	5	008600330
4	25	5	008600335

860PE

hexagon bits for power drivers, coloured



ISO 2351-3
ISO 1173 C 6,3

mm	L		
mm	mm		
2	25	5	008600101
2,5	25	5	008600102
3	25	5	008600103
4	25	5	008600104
5	25	5	008600105
6	25	5	008600106
8	25	5	008600108
10	25	5	008600110



860TX

bits for Torx® head screws, coloured



ISO 1173 C 6,3

	L mm		
T6	25	5	008600704
T7	25	5	008600705
T8	25	5	008600710
T9	25	5	008600715
T10	25	5	008600720
T15	25	5	008600725
T20	25	5	008600730
T25	25	5	008600735
T27	25	5	008600740
T30	25	5	008600745
T40	25	5	008600750

860RTX

bits for Tamper Resistant Torx® head screws, coloured



ISO 1173 C 6,3

	L mm		
T9	25	5	008600550
T10	25	5	008600555
T15	25	5	008600560
T20	25	5	008600565
T25	25	5	008600570
T27	25	5	008600575
T30	25	5	008600580
T40	25	5	008600585

860/55

reversible bit ratchet



L mm	Ø 1/4		
100	1/4	3	008600870

860/58

bit ratchet with rotating handle

- Bit can be fitted onto both sides, for screwing or unscrewing
- Bi-material handle



L mm	Ø 1/4"		
860/58	126	1	008600884

860/C27

25 bits, 1 connector and 1 reversible ratchet in plastic case



860/C27 1 008600880

	860/55	100 mm
	860LP	0,5x3-1,0x5-1,2x6,5 mm
	860PH	PH1-PH2(x2)-PH3
	860PZ	PZ1-PZ2(x2)-PZ3
	860PE	2-2,5-3-4-5-6 mm
	860TX	T6-T8-T10-T15-T20-T25-T30-T40
	892/0	● 1/4 ■ 1/4

860PHZ/A10

set of 10 bits with magnetic bit holder in plastic case



860PHZ/A10 1 008600910

	860PH	PH1 PH2 PH3	n. 1 3 1
	860PZ	PZ1 PZ2 PZ3	1 3 1
	882M1	○ 1/4 ● 1/4	

860PHZ/A31

set of 30 bits with magnetic quick release bit holder in plastic case



860PHZ/A31 1 008600912

	860PH	PH1 PH2 PH3	n. 3 9 3
	860PZ	PZ1 PZ2 PZ3	3 9 3
	882MSR/50	○ 1/4 ● 1/4	

860PE/A10

set of 10 bits with magnetic bit holder in plastic case



860PE/A10 1 008600920

	860PE	2 - 2,5 mm 3 - 4 - 5 - 6 mm	n. 1 2
	882M1	○ 1/4 ● 1/4	

860TX/A10

set of 10 bits with magnetic bit holder in plastic case



860TX/A10 1 008600970

	860TX	T7 - T8 - T9 - T10 - T15 - T20	n. 1
	882M1	T25 - T27 - T30 - T40 ○ 1/4 ● 1/4	

860TX/A31

set of 30 bits with magnetic quick release bit holder in plastic case



860TX/A31

1 008600972

	860TX	T6 - T7 - T8	n.
		T9 - T10 - T15 - T20 - T25	2
		T27 - T30 - T40	3
	882MSR/50	○ 1/4 ● 1/4	

860PHT/A31

set of 30 bits with magnetic quick release bit holder in plastic case



860PHT/A31

1 008600940

	860PH	PH1	n.
		PH2	3
	860TX	T10 - T15 - T20 - T25 - T27 - T30 - T40	6
	882MSR/50	○ 1/4 ● 1/4	3

860RTX/A10

set of 10 bits with magnetic bit holder in plastic case



860RTX/A10

1 008600930

	860RTX	T9-T10-T15-T20-T25-T27	n.
		T30-T40	
	882M1	○ 1/4 ● 1/4	

860MIX/A10

set of 10 bits with magnetic bit holder in plastic case



860MIX/A10

1 008600900

	860LP	0,5x3 - 1x5,5 - 1,2x6,5 mm	n.
	860PH	PH1	1
		PH2	2
		PH3	1
	860PZ	PZ1 - PZ2 - PZ3	1
	882M1	○ 1/4 ● 1/4	

860MIX/A31

set of 30 bits with magnetic quick release bit holder in plastic case



860MIX/A31

1 008600902

	860LP	0,5x3 - 0,6x4 - 0,8x5,5	n.
		1,0x5,5 - 1,2x6,5 mm	
	860PE	2 - 2,5 - 3 - 4 - 5 - 6	
		8 - 10 mm	
	860PH	PH0 - PH1 - PH2 - PH3 - PH4	
	860PZ	PZ1 - PZ2 - PZ3 - PZ4	
	860RTX	T9 - T10 - T15 - T20	
		T25 - T27 - T30 - T40	
	882MSR/50	○ 1/4 ● 1/4	

860/C38P

1 reversible ratchet bit holder with articulated handle, 27 bits, 8 hexagon sockets and 2 accessories



860/C38P

1 008600878

	860LP	0,6x4,5 - 0,8x5,5 - 1,0x5,5 - 1,2x6,5 mm	n.
	860PE	2-2,5-3-4(x2)-5(x2)	
	860PH	PH1(x2)-PH2(x2)-PH3	
	860PZ	PZ1(x2)-PZ2(x2)-PZ3	
	860TX	T10-T15-T20-T25-T30-T40	
	900	5-5,5-6-7-8-9-10-13 mm	
	892/0	● 1/4 ■ 1/4	
	892/3	● 1/4 ■ 1/4	
	855P	240 mm	

270x120x45 mm

861LP

bits for slotted head screws



ISO 2351-1

ISO 1173 C 6,3

SxA	L		
mm	mm		
0,5x3	25	10	008610005
0,6x4	25	10	008610007
0,6x4,5	25	10	008610010
0,8x5,5	25	10	008610015
1x5,5	25	10	008610020
1,2x6,5	25	10	008610025
1,2x8	25	10	008610028
1,6x8	25	10	008610030

861PH

bits for cross head Phillips® screws



ISO 2351-2

ISO 1173 C 6,3

PH	L		
	mm		
0	25	10	008610200
1	25	10	008610205
2	25	10	008610210
2L	50	10	008610213
3	25	10	008610215
4	25	10	008610220



861PH/C

bits for cross head Phillips® screws

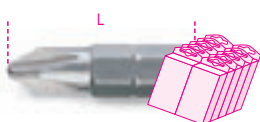

ISO 2351-2
ISO 1173 C 6,3

PH	L mm		
0	25	200	008610250
1	25	200	008610255
2	25	200	008610260
2L	50	100	008610263
3	25	200	008610265
4	25	100	008610270

861PZ

bits for cross head
Pozi driv®-Supadriv® screws



ISO 2351-2

ISO 1173 C 6,3

PZ	L mm		
1	25	10	008610300
2	25	10	008610305
2L	50	10	008610308
3	25	10	008610310
4	25	10	008610315

861PZ/C

bits for cross head
Pozi driv®-Supadriv® screws

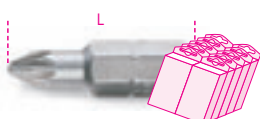

ISO 2351-2
ISO 1173 C 6,3

PZ	L mm		
1	25	200	008610350
2	25	200	008610355
2L	50	100	008610358
3	25	200	008610360
4	25	100	008610365

861PE

hexagon bits for power drivers



ISO 2351-3

ISO 1173 C 6,3

mm	L mm		
2	25	10	008610100
2,5	25	10	008610105
3	25	10	008610110
4	25	10	008610115
5	25	10	008610120
6	25	10	008610125
8	25	10	008610130
10	25	10	008610135

861TX

bits for Torx® head screws



ISO 1173 C 6,3

	L mm		
T5	25	10	008610399
T6	25	10	008610400
T7	25	10	008610405
T8	25	10	008610410
T9	25	10	008610415
T10	25	10	008610420
T15	25	10	008610425
T20	25	10	008610430
T25	25	10	008610435
T27	25	10	008610440
T30	25	10	008610445
T40	25	10	008610450

861TX/C

bits for Torx® head screws

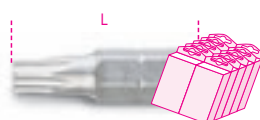

ISO 1173 C 6,3

	L mm		
T10	25	200	008610470
T15	25	200	008610475
T20	25	200	008610480
T25	25	200	008610485
T27	25	200	008610490
T30	25	200	008610495
T40	25	200	008610499

861RTX

bits for Tamper Resistant Torx®
head screws



ISO 1173 C 6,3

	L mm		
T7	25	10	008610538
T9	25	10	008610500
T10	25	10	008610505
T15	25	10	008610510
T20	25	10	008610515
T25	25	10	008610520
T27	25	10	008610525
T30	25	10	008610530
T40	25	10	008610535
T45	25	10	008610539

861RIBE

bits for RIBE® screws



ISO 1173 C 6,3

	L mm		
M5	25	10	008610705
M6	25	10	008610706
M7	25	10	008610707
M8	25	10	008610708
M9	25	10	008610709

861TRW

bits for Tri-Wing® head screws



ISO 1173 C 6,3

GR	L mm		
1	25	10	008610601
2	25	10	008610602
3	25	10	008610603
4	25	10	008610604
5	25	10	008610605
6	25	10	008610606

861TQS

bits for Torq-Set® head screws



ISO 1173 C 6,3

GR	L mm		
0	25	10	008610620
1	25	10	008610621
2	25	10	008610622
3	25	10	008610623
4	25	10	008610624
5	25	10	008610625
6	25	10	008610626
8	25	10	008610628
10	25	10	008610630

861SP

bits for Spanner screws



ISO 1173 C 6,3

SP	D mm	L mm		
4	1,5	25	10	008610650
6	2,4	25	10	008610653
8	2,8	25	10	008610656
10	3,3	25	10	008610658
12	3,9	25	10	008610660

1483KV-PT/S7



1483KV PT/S7

193

861XZN

bits for XZN® screws



ISO 1173 C 6,3

	L mm		
M5	25	10	008610725
M6	25	10	008610726
M8	25	10	008610728

861/C61P

61 bits and 1 magnetic quick release bit holder

1/4



861/C61P

1 008610978

	861LP	0,5x3 - 0,6x4,5 - 0,8x5,5 - 1,0x5,5 1,2x6,5 - 1,2x8 - 1,6x8 mm
	861PE	2 - 2,5 - 3 - 4 - 5 - 6 - 8 - 10 mm
	861PH	PH0 - PH1 - PH2 - PH3
	861PZ	PZ1 - PZ2 - PZ3
	861TX	T6 - T7 - T8 - T9 - T10 - T15 T20 - T25 - T27 - T30 - T40
	861RTX	T9 - T10 - T15 - T20 - T25 T27 - T30 - T40
	861TRW	1 - 2 - 3 - 4 - 5 - 6
	861TQS	0 - 1 - 2 - 3 - 4 - 5 - 6 - 8 - 10
	861SP	4 - 6 - 8 - 10 - 12
	851SR	○ 1/4"

270x120x45 mm - 975 g

862LP

bits for slotted head screws

1/4



ISO 2351-1

ISO 1173 E 6,3

SxA mm	L mm		
0,5x3	50	5	008620005
0,6x4,5	50	5	008620010
0,8x5,5	50	5	008620015
1x5,5	50	5	008620020
1,2x6,5	50	5	008620025
1,2x8	50	5	008620030
1,6x8	50	5	008620035

862PH

bits for cross head Phillips® screws

1/4



ISO 2351-2

ISO 1173 E 6,3

PH	L mm		
1	50	5	008620200
2	50	5	008620205
3	50	5	008620210

862PH/L

bits for cross head Phillips® screws

1/4



ISO 2351-2

ISO 1173 E 6,3

PH	L mm		
1	70	5	008620230
2	70	5	008620232
3	70	5	008620234

862PZ

bits for cross head Pozidriv®-Supadriv® screws

1/4



ISO 2351-2

ISO 1173 E 6,3

PZ	L mm		
1	50	5	008620300
2	50	5	008620305
3	50	5	008620310

862PE

hexagon bits for power drivers

1/4



ISO 2351-3

ISO 1173 E 6,3

mm	L mm		
3	50	5	008620103
4	50	5	008620104
5	50	5	008620105
6	50	5	008620106
8	50	5	008620108

862TX

bits for Torx® head screws

1/4



ISO 1173 E 6,3

T	L mm		
T9	50	5	008620509
T10	50	5	008620510
T15	50	5	008620515
T20	50	5	008620520
T25	50	5	008620525
T27	50	5	008620527
T30	50	5	008620530
T40	50	5	008620540

862TX/L

bits for Torx® head screws

1/4



ISO 1173 E 6,3

T	L mm		
T9	70	5	008620559
T10	70	5	008620560
T15	70	5	008620565
T20	70	5	008620570
T25	70	5	008620575
T27	70	5	008620577
T30	70	5	008620580
T40	70	5	008620590

862F

magnetic bits, hexagon sockets

1/4



ISO 1173 E 6,3

mm	L mm	Ø mm		
5,5	65	11	5	008620405
6	65	11	5	008620406
7	65	11	5	008620407
8	65	13	5	008620408
10	65	15	5	008620410
12	65	18	5	008620412
13	65	18	5	008620413

862F/A7

7 magnetic bits, hexagon sockets, in plastic case

1/4



862F/A7

1 008620950

862F 5,5-6-7-8-10-12-13 mm

866LP

bits for slotted head screws

5/16



ISO 2351-1
ISO 1173 C 8

SxA mm	L mm		
1x5,5	41	10	008660005
1,2x6,5	41	10	008660010
1,6x8	41	10	008660015
1,6x10	41	10	008660020
2x12	41	10	008660025

866PH

bits for cross head Phillips® screws



ISO 2351-2

ISO 1173 C 8

PH	L mm		
1	32	10	008660200
2	32	10	008660205
3	32	10	008660210
4	38	10	008660215

866PZ

bits for cross head Pozidriv®-Supadriv® screws



ISO 2351-2

ISO 1173 C 8

PZ	L mm		
1	32	10	008660300
2	32	10	008660305
3	32	10	008660310
4	38	10	008660315

866PE

hexagon bits for power drivers



ISO 2351-3

ISO 1173 C 8

mm	L mm		
3	30	10	008660100
4	30	10	008660105
5	30	10	008660110
6	30	10	008660115
7	30	10	008660117
8	30	10	008660120
10	30	10	008660125
12	30	10	008660132
14	30	10	008660134

866TX

bits for Torx® head screws



ISO 1173 C 8

	L mm		
T20	30	10	008660400
T25	30	10	008660405
T27	30	10	008660410
T30	30	10	008660415
T40	30	10	008660420
T45	30	10	008660425
T50	30	10	008660430
T55	30	10	008660435
T60	30	10	008660440
T70	30	10	008660445

866RTX

bits for Tamper Resistant Torx® head screws



ISO 1173 C 8

	L mm		
T40	30	10	008660520
T45	30	10	008660525
T50	30	10	008660530
T55	30	10	008660535
T60	30	10	008660540
T70	30	10	008660545

867PE

hexagon bits



mm	L mm		
4	30	5	008670104
5	30	5	008670105
6	30	5	008670106
7	30	5	008670107
8	30	5	008670108
10	30	5	008670110
12	30	5	008670112

867PE/L

hexagon bits



mm	L mm		
4	75	5	008670154
5	75	5	008670155
6	75	5	008670156
7	75	5	008670157
8	75	5	008670158
10	75	5	008670160
12	75	5	008670162

867XZN

bits with XZN® profile



	L mm		
M4	30	5	008670204
M5	30	5	008670205
M6	30	5	008670206
M8	30	5	008670208
M10	30	5	008670210
M12	30	5	008670212

867XZN/L

bits with XZN® profile



	L mm		
M5	75	5	008670255
M6	75	5	008670256
M8	75	5	008670258
M10	75	5	008670260
M12	75	5	008670262

867TX

bits for Torx® head screws



	L mm		
T20	30	5	008670400
T25	30	5	008670405
T30	30	5	008670410
T40	30	5	008670415
T45	30	5	008670420
T50	30	5	008670425
T55	30	5	008670430

867TX/L

bits for Torx® head screws



	L mm		
T20	75	5	008670450
T25	75	5	008670455
T30	75	5	008670460
T40	75	5	008670465
T45	75	5	008670470
T50	75	5	008670475
T55	75	5	008670480

867RTX

bits for Tamper Resistant Torx® head screws



	L mm		
T20	30	5	008670500
T25	30	5	008670505
T30	30	5	008670510
T40	30	5	008670515
T45	30	5	008670520
T50	30	5	008670525
T55	30	5	008670530

867RTX/L

bits for Tamper Resistant Torx® head screws



	L		
	mm		
T20	75	5	008670550
T25	75	5	008670555
T30	75	5	008670560
T40	75	5	008670565
T45	75	5	008670570
T50	75	5	008670575
T55	75	5	008670580

867RIBE

bits for RIBE® screws



	L		
	mm		
M5	30	5	008670705
M6	30	5	008670706
M7	30	5	008670707
M8	30	5	008670708
M9	30	5	008670709
M10	30	5	008670710
M11	30	5	008670711
M12	30	5	008670712
M13	30	5	008670713

867RIBE/L

bits for RIBE® screws



	L		
	mm		
M5	75	5	008670755
M6	75	5	008670756
M7	75	5	008670757
M8	75	5	008670758
M9	75	5	008670759
M10	75	5	008670760
M11	75	5	008670761
M12	75	5	008670762
M13	75	5	008670763

867/...

bit holder sockets for item 867



	Ø	□	L	Ø		
	mm	mm	mm	mm		
867/1	10	3/8"	38	17	5	008670600
867/2	10	1/2"	38	22	5	008670601

867/C52

52 hexagon bits, 10 mm and 2 accessories

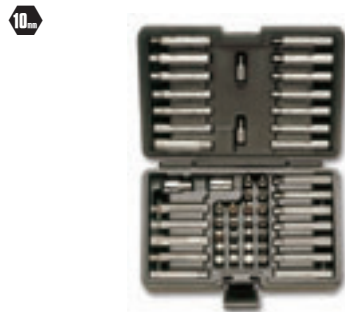

867/C52 1 008670901

○ 867PE	4-5-6-7-8-10-12 mm
○ 867PE/L	4-5-6-7-8-10-12 mm
○ 867XZN	M5-M6-M8-M10-M12
○ 867XZN/L	M5-M6-M8-M10-M12
⊕ 867TX	T20-T25-T30-T40-T45-T50-T55
⊕ 867TX/L	T20-T25-T30-T40-T45-T50-T55
⊕ 867RTX	T20-T25-T30-T40-T45-T50-T55
⊕ 867RTX/L	T20-T25-T30-T40-T45-T50-T55
867/1	○ 10 mm - □ 3/8"
867/2	○ 10 mm - □ 1/2"

250x170x70 mm - 2,1 kg

882

bit holder with retaining ring for drivers



ISO 1173 E 6,3

L	Ø		
mm	mm		
57	11	1/4	1/4

5 008820001

882M1

magnetic bit holder



ISO 1173 E 6,3

L	Ø		
mm	mm		
50	11	1/4	1/4

5 008820006

882M

magnetic bit holder



ISO 1173 E 6,3

L	Ø		
mm	mm		
75	11	1/4	1/4

5 008820005

882MSR

magnetic quick release bit holder for drivers

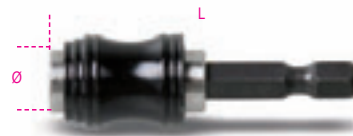

ISO 1173 E 6,3

L	Ø		
mm	mm		
50	11	1/4	1/4
75	11	1/4	1/4

5 008820205
5 008820207

882P

magnetic bit holder extension bar



L	Ø		
mm	mm		
80	10	1/4	1/4

5 008820080

892

adaptors for drivers



	Ø	Ø	L		
	mm	mm	mm		
892/0	1/4	1/4	25	5	008920000
* 892/1	1/4	5,5	50	5	008920001
* 892/2	3/8	5,5	50	5	008920002
* 892/3	1/4	1/4	50	5	008920003
* 892/4	3/8	1/4	50	5	008920004
892/5	1/4	5/16	75	5	008920005
892/6	3/8	5/16	75	5	008920006
892/7	1/2	1/4	75	5	008920007

* ISO 1173 A 5,5
° ISO 1173 C 6,3

895

socket holder for bits
item 861 - 862 - 866



DIN 7427

	□	□	L	∅		
	mm	mm	mm	mm		
895/1	1/4	1/4	25,4	12	5	008950000
895/3	1/4	3/8	29	16,8	5	008950001
895/4	5/16	3/8	29	16,8	5	008950002
895/5	1/4	1/2	38	22	5	008950005
895/6	5/16	1/2	38	22	5	008950003

897

flexible bit holder with handle



L	L1		
mm	mm		
280	154	2	008970010

897L

flexible bit holder with handle, long model



L	L1		
mm	mm		
500	380	2	008970015

900

hexagon hand sockets



UNI/ISO 2725 DIN 3124

∅	∅	L	∅1		
mm	mm	mm	mm		
4	6,8	25	11,8	10	009000040
4,5	7,4	25	11,8	10	009000045
5	8,0	25	11,8	10	009000050
5,5	8,7	25	11,8	10	009000055
6	9,3	25	11,8	10	009000060
7	10,4	25	11,8	10	009000070
8	11,8	25	12,7	10	009000080
9	12,7	25	11,8	10	009000090
10	14,2	25	12,0	10	009000100
11	15,8	25	12,5	10	009000110
12	17,2	25	13,5	10	009000120
13	18,0	25	13,5	10	009000130
14	20,0	25	15,0	10	009000140



900/SB13		
4-4,5-5-5,5-6-7-8-9	1	009000150
10-11-12-13-14 mm		

900MB

bi-hex hand sockets



UNI/ISO 2725 DIN 3124

∅	∅	L	∅1		
mm	mm	mm	mm		
4	7,7	22	11,2	5	009000160
5	8,0	25	11,8	5	009000161
5,5	8,7	25	11,8	5	009000162
6	9,3	25	11,8	5	009000163
7	10,4	25	11,8	5	009000164
8	11,8	25	12,7	5	009000165
9	12,7	25	11,8	5	009000166
10	14,2	25	12,0	5	009000167
11	15,8	25	12,5	5	009000168
12	17,2	25	13,5	5	009000169
13	18,0	25	13,5	5	009000170
14	20,0	25	15,0	5	009000171



900MB/SB12		
4-5-5,5-6-7-8-9-10	1	009000179
11-12-13-14 mm		

900L

hexagon hand sockets, long series



UNI/ISO 2725 DIN 3124

∅	∅	L	∅1		
mm	mm	mm	mm		
4	6,5	50	12,0	5	009000181
4,5	7,0	50	12,0	5	009000182
5	7,5	50	12,0	5	009000183
5,5	8,5	50	12,0	5	009000184
6	9,5	50	12,0	5	009000185
7	10,5	50	12,0	5	009000186
8	12,0	50	12,0	5	009000187
9	13,0	50	13,0	5	009000188
10	14,0	50	14,0	5	009000189
11	16,0	50	16,0	5	009000190
12	17,5	50	17,5	5	009000191
13	17,5	50	17,5	5	009000192
14	20,0	50	20,0	5	009000193



900L/SB13		
4-4,5-5-5,5-6-7-8-9-10-11-12-13-14 mm	1	009000203

900MB/L

bi-hex hand sockets, long series

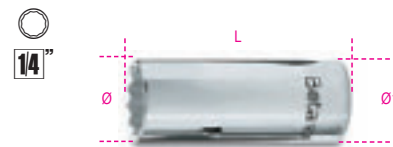

UNI/ISO 2725 DIN 3124

∅	∅	L	∅1		
mm	mm	mm	mm		
5	8,0	50	12,0	3	009000211
6	9,3	50	12,0	3	009000212
7	10,9	50	12,0	3	009000213
8	11,6	50	12,0	3	009000214
9	13,0	50	12,0	3	009000215
10	14,3	50	12,8	3	009000216
11	16,0	50	14,2	3	009000217
12	17,4	50	15,5	3	009000218
13	18,0	50	16,2	3	009000219
14	19,0	50	17,1	3	009000220

900AS

hexagon hand sockets



∅	∅	L	∅1		
mm	mm	mm	mm		
5/32	8,8	25	11,9	5	009000349
3/16	7,7	25	11,9	5	009000340
7/32	8,8	25	11,9	5	009000345
1/4	9,6	25	11,9	5	009000350
9/32	10,2	25	11,9	5	009000355
5/16	11,3	25	11,9	5	009000360
11/32	12,7	25	11,6	5	009000365
3/8	14,0	25	12,9	5	009000370
7/16	15,3	25	14,5	5	009000375
1/2	17,5	25	16,4	5	009000380
9/16	19,0	25	17,9	5	009000385



900AS/SB11		
3/16-7/32-5/32-1/4-9/32-5/16-11/32-3/8-7/16-1/2-9/16	1	009000389

900AS/MB

bi-hex hand sockets



SAE AS 954E

"	∅	L	∅1		
mm	mm	mm	mm		
3/16	8,0	22	10,0	2	009000390
7/32	8,6	22	10,0	2	009000391
1/4	9,6	22	10,0	2	009000392
9/32	10,0	22	10,0	2	009000393
5/16	11,9	22	11,9	2	009000394
11/32	12,0	22	12,0	2	009000395
3/8	13,9	22	13,9	2	009000396
7/16	15,2	22	15,2	2	009000397
1/2	17,2	22	17,2	2	009000398
9/16	19,0	24	19,0	2	009000399

900AS/L

hexagon hand sockets, long series



"	Ø mm	L mm	Ø1 mm	Hand	Part No.
3/16	7,0	50	12,0	Left	2 009000301
7/32	8,5	50	12,0	Right	2 009000303
1/4	9,8	50	12,0	Left	2 009000305
9/32	10,5	50	12,0	Right	2 009000307
5/16	12,0	50	12,0	Left	2 009000309
11/32	13,0	50	13,0	Right	2 009000311
3/8	14,0	50	14,0	Left	2 009000313
7/16	16,0	50	16,0	Right	2 009000315
1/2	17,5	50	17,5	Left	2 009000317
9/16	20,0	50	20,0	Right	2 009000319

900AS/MBL

bi-hex hand sockets, long series



"	Ø mm	L mm	Ø1 mm	Hand	Part No.
5/32	6,8	50	12,0	Left	2 009000325
3/16	8,0	50	12,0	Right	2 009000326
7/32	8,5	50	12,0	Left	2 009000327
1/4	9,8	50	12,0	Right	2 009000328
9/32	10,9	50	12,0	Left	2 009000329
5/16	11,6	50	12,0	Right	2 009000330
11/32	13,0	50	12,0	Left	2 009000331
3/8	14,3	50	12,8	Right	2 009000332
7/16	16,0	50	14,2	Left	2 009000333
1/2	18,0	50	16,2	Right	2 009000334
9/16	19,0	50	17,1	Left	2 009000335

900FTX

hand sockets for Torx® head screws

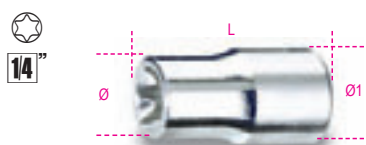

"	Ø mm	L mm	Ø1 mm	Hand	Part No.
E4	5,4	22	11,2	Left	5 009000404
E5	6,7	22	11,2	Right	5 009000405
E6	7,7	22	11,2	Left	5 009000406
E7	8,3	22	11,2	Right	5 009000407
E8	9,6	22	11,2	Left	5 009000408
E10	11,3	22	12,0	Right	5 009000410
E11	12,1	22	12,5	Left	5 009000411
E12	12,9	23	12,9	Right	5 009000412
E14	14,0	25	14,0	Left	5 009000414



900FTX/SB9
E4-E5-E6-E7-E8
E10-E11-E12-E14
1 009000419

900LP

socket drivers for slotted head screws

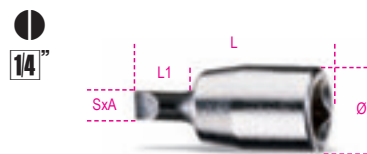

SxA mm	Ø mm	L mm	L1 mm	Hand	Part No.
0,8x4	12	28	9	Left	5 009000605
1x5,5	12	28	9	Right	5 009000610
1,2x6,5	12	28	9	Left	5 009000615
1,2x8	13	28	8	Right	5 009000620
1,6x10	14	28	8	Left	5 009000625

900PH

socket drivers for cross head Phillips® screws



PH	Ø mm	L mm	L1 mm	Hand	Part No.
1	12	28	12	Left	5 009000701
2	12	28	12	Right	5 009000702
3	12	28	12	Left	5 009000703
4	13	28	11	Right	5 009000704

900ME

socket drivers for hexagon screws



mm	Ø mm	L mm	L1 mm	Hand	Part No.
2,5	12	25	4,5	Left	5 009000502
3	12	25	5,0	Right	5 009000503
4	12	25	5,6	Left	5 009000504
5	12	25	6,3	Right	5 009000505
6	12	25	7,6	Left	5 009000506
7	13	25	7,2	Right	5 009000507
8	13	25	8,0	Left	5 009000508
10	13	25	8,7	Right	5 009000510



900ME/SB8
2,5-3-4-5-6-7-8-10 mm
1 009000518

900PT

socket drivers for 5-star head screws



"	Ø mm	L mm	L1 mm	Hand	Part No.
PT10	12	28	12	Left	5 009000750
PT15	12	28	12	Right	5 009000755
PT20	12	28	12	Left	5 009000760
PT25	12	28	12	Right	5 009000765
PT27	12	28	12	Left	5 009000767
PT30	12	28	12	Right	5 009000770

900TX

socket drivers for Torx® head screws



"	Ø mm	L mm	L1 mm	Hand	Part No.
T8	12	28	12	Left	5 009000719
T9	12	28	12	Right	5 009000720
T10	12	28	12	Left	5 009000721
T15	12	28	12	Right	5 009000722
T20	12	28	12	Left	5 009000723
T25	12	28	12	Right	5 009000724
T27	12	28	12	Left	5 009000725
T30	12	28	12	Right	5 009000726
T40	12	28	12	Left	5 009000727



900TX/SB8
T9-T10-T15-T20
T25-T27-T30-T40
1 009000730

900/16

adaptor, 1/4" female and 3/8" male drives



UNI/ISO 3316 DIN 3123

L mm	Ø mm	Hand	Part No.
28	13,0	1/4 3/8	5 009000814

900/...

1/4" female and male drive extension bars

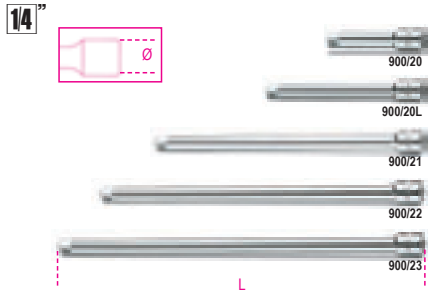

UNI/ISO 3316 DIN 3123

	L mm	Ø mm	
900/20	50	11,5	5 009000818
900/20L	100	11,5	5 009000819
900/21	150	11,5	5 009000822
900/22	250	11,5	5 009000823
900/23	350	11,5	5 009000824

900AN

1/4" wobble extension bars

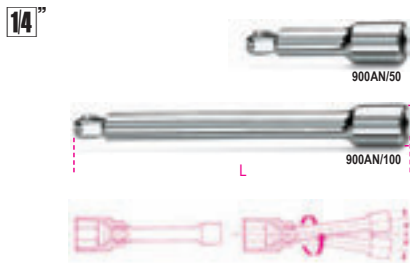

	L mm	Ø mm	
900AN/50	50	11,5	3 009000825
900AN/100	100	11,5	3 009000826

900FL

1/4" flexible universal extension bar

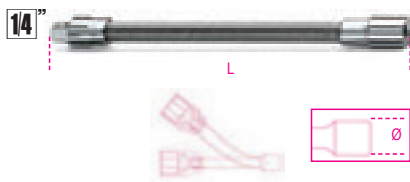

	L mm	Ø mm	
	150	12	3 009000828

900/25

1/4" drive universal joint



UNI/ISO 3316 DIN 3123

	L mm	Ø mm	
	41	12,5	5 009000830

900BG/30C

1/4" drive spinner handle

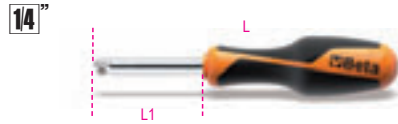

UNI/ISO 3315 DIN 3122

	L mm	L1 mm	
	128	20	5 009000833

900BG/30

1/4" drive spinner handle



UNI/ISO 3315 DIN 3122

	L mm	L1 mm	
	176	68	5 009000834

900/32

1/4" drive flexible handle

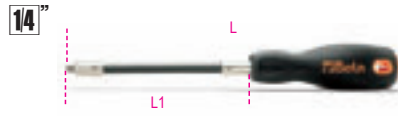

	L mm	L1 mm	
	280	154	2 009000839

900/35A

1/4" drive swivel handle



UNI/ISO 3315 DIN 3122

	L mm	L1 mm	
	148	84	5 009000840

900M/35

1/4" swivel drive with metal handle



UNI/ISO 3315
DIN 3122

	L mm	L1 mm	
	130		3 009000845

900/40

1/4" drive swivel T-handle



	L mm	L1 mm	
	390	145	3 009000843

900/42

1/4" drive sliding T-handle

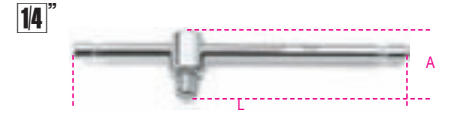

UNI/ISO 3315 DIN 3122

	L mm	A mm	
	115	22	5 009000854

900T/44

1/4" male drive, bent, with high torque handle



	L mm	L1 mm	
	238	105	2 009000860

900/55

1/4" drive reversible ratchet, 48 teeth



UNI/ISO 3315 DIN 3122

	L mm	Ø mm	A mm	
	125	25	18	5 009000870

900M/55

1/4" drive reversible ratchet with metal handle



UNI/ISO 3315
DIN 3122

	L mm	Ø mm	A mm	
	110	22	18	3 009000905

900/58

1/4" drive reversible ratchet with rotating handle, 52 tooth mechanism

- Socket release button
- Ring nut reversal system on ratchet head
- Bi-material handle



L mm	Ø mm	A mm	1	009000884
126	28	28,5	2	

Spare parts
rotating mechanism of ratchets,
see table after item 929/C8

900/C39

11 hexagon sockets, 21 bits and 7 accessories



900/C39 1 009000937

	861LP	0,6x4,5 - 1,2x6,5 - 1,2x8 mm
	861PH	PH1-PH2-PH3
	861PZ	PZ1-PZ2-PZ3
	861PE	2,5-3-4-5-6 mm
	861RTX	T10-T15-T20-T25-T27-T30-T40
	900	5-5,5-6-7-8-9-10-11-12-13-14 mm
	900/20	50 mm
	900/20L	100 mm
	900/25	
	900BG/30C	
	900/55	
	892/0	
	895/1	

900/C11

11 hexagon sockets, 20 bits and 8 accessories



900/C11 1 009000971

	861LP	0,5x3 - 0,8x5,5 1x5,5 - 1,2x6,5 mm
	861PE	3 - 4 - 5 - 6 - 8 mm
	861PH	0 - 1 - 2 - 3
	861TX	T8 - T10 - T15 - T20 T25 - T30 - T40
	895/1	
	900	5 - 5,5 - 6 - 7 - 8 - 9 - 10 11 - 12 - 13 - 14 mm
	900/16	□ 1/4 - ■ 3/8
	900/20	50 mm
	900/21	150 mm
	900/25	
	900BG/30	
	900/42	
	900/55	

270x120x45 mm - 1,2 kg

900/C13-5

13 hexagon sockets and 5 accessories



900/C13-5 1 009000953

	900	4 - 4,5 - 5 - 5,5 - 6 - 7 - 8 - 9 10 - 11 - 12 - 13 - 14 mm
	900/21	150 mm
	900/25	
	900BG/30	
	900/42	
	900/55	

270x120x45 mm - 1 kg

900/C13-8

13 hexagon sockets and 8 accessories



900/C13-8 1 009000954

	900	4 - 4,5 - 5 - 5,5 - 6 - 7 - 8 - 9 10 - 11 - 12 - 13 - 14 mm
	900/16	□ 1/4 - ■ 3/8
	900/20	50 mm
	900/21	150 mm
	900/25	
	900BG/30	
	900/35A	
	900/42	
	900/55	

270x120x45 mm - 1,1 kg

900MB/C19

11 bi-hex sockets and 8 accessories



900MB/C19 1 009000977

	900MB	5 - 5,5 - 6 - 7 - 8 - 9 - 10 - 11 12 - 13 - 14 mm
	900/16	□ 1/4 - ■ 3/8
	900/20	50 mm
	900/21	150 mm
	900/25	
	900BG/30	
	900/35A	
	900/42	
	900/55	

270x120x45 mm - 1,1 kg

900/C24

13 hexagon sockets, 11 socket drivers and 6 accessories

1/4"



900/C24

1 009000956

	○ 900	4 - 4,5 - 5 - 5,5 - 6 - 7 - 8 - 9 10 - 11 - 12 - 13 - 14 mm
	● 900LP	0,8x4 - 1,2x6,5 - 1,2x8 mm
	⊕ 900PH	PH1 - PH2 - PH3
	○ 900ME	3 - 4 - 5 - 6 - 8 mm
	900/20	50 mm
	900/21	150 mm
	900/25	
	900BG/30	
	900/42	
	⊕ 900/55	
≡ 270x120x45 mm - 1,1 kg		

900MB/C28

11 bi-hex sockets, 11 socket drivers and 6 accessories

1/4"



900MB/C28

1 009000979

	○ 900MB	5 - 5,5 - 6 - 7 - 8 - 9 - 10 - 11 12 - 13 - 14 mm
	● 900LP	0,8x4 - 1,2x6,5 - 1,2x8 mm
	⊕ 900PH	PH1 - PH2 - PH3
	○ 900ME	3 - 4 - 5 - 6 - 8 mm
	900/20	50 mm
	900/21	150 mm
	900/25	
	900BG/30	
	900/42	
	⊕ 900/55	
≡ 270x120x45 mm - 1,1 kg		

900AS/C10 - /MB-C17

10 sockets and 7 accessories

1/4"



900AS/C10

1 009000961

	○ 900AS	3/16 - 7/32 - 1/4 - 9/32 - 5/16 11/32 - 3/8 - 7/16 - 1/2 - 9/16
	900/20	50 mm
	900/21	150 mm
	900/25	
	900BG/30	
	900/35A	
	900/42	
	⊕ 900/55	
≡ 270x120x45 mm - 1,1 kg		

900AS/MB-C17

1 009000981

	○ 900AS/MB	3/16 - 7/32 - 1/4 - 9/32 - 5/16 11/32 - 3/8 - 7/16 - 1/2 - 9/16
	900/20	50 mm
	900/21	150 mm
	900/25	
	900BG/30	
	900/35A	
	900/42	
	⊕ 900/55	
≡ 270x120x45 mm - 1,1 kg		

900AS/C17-MBM

10 bi-hex sockets and 7 accessories for aeronautical maintenance

1/4"



900AS/C17-MBM

1 009000982

	○ 900AS/MB	3/16 - 7/32 - 1/4 - 9/32 - 5/16 11/32 - 3/8 - 7/16 - 1/2 - 9/16
	900/20	50 mm
	900/21	150 mm
	900/25	
	900BG/30	
	900M/35	
	900/42	
	900M/55	
≡ 270x120x45 mm - 1,2 kg		

900/C11HR

11 hexagon sockets, 20 bits and 7 accessories in hard foam tray, in metal case

• ratchet with rotating handle

1/4"

1/4"



900/C11HR

1 009000980

	● 861LP	0,5x3-0,8x5,5-1x5,5-1,2x6,5 mm
	⊕ 861PH	PH0-PH1-PH2-PH3
	○ 861PE	3-4-5-6-8 mm
	⊕ 861TX	T8-T10-T15-T20-T25-T30-T40
	895/1	
	○ 900	5-5,5-6-7-8-9-10-11-12-13-14 mm
	900/16	□ 1/4 - ■ 3/8
	900/20	50 mm
	900/21	150 mm
	900/25	
	900/42	
	900/30	
	900/58	
≡ 350x150x50 mm - 1,3 kg		

902R/C6

6 adaptors for socket drivers



902R/C6

1 009020814

	900/16	□ 1/4 - ■ 3/8
	910/15	□ 3/8 - ■ 1/4
	910/16	□ 3/8 - ■ 1/2
	920/15	□ 1/2 - ■ 3/8
	920/16	□ 1/2 - ■ 3/4
	928/15	□ 3/4 - ■ 1/2
≡ 170x100x35 mm - 600 g		

910A

hexagon hand sockets

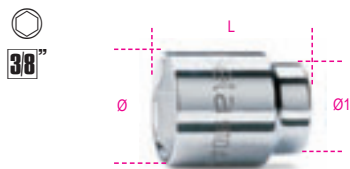

UNI/ISO 2725 DIN 3124

mm	Ø	L	Ø1		
6	9,5	28	16,7	5	009100006
7	10,7	28	16,7	5	009100007
8	12,1	28	16,7	5	009100008
9	13,2	28	16,7	5	009100009
10	14,6	29	16,7	5	009100010
11	15,8	29	16,7	5	009100011
12	17,2	30	17,7	5	009100012
13	18,4	31	17,0	5	009100013
14	19,7	32	17,5	5	009100014
15	20,9	32	18,0	5	009100015
16	22,2	33	18,5	5	009100016
17	23,2	33	19,0	5	009100017
18	24,7	34	20,0	5	009100018
19	25,8	35	21,0	5	009100019
20	27,2	35	22,0	5	009100020
21	28,2	36	23,0	5	009100021
22	29,7	37	24,0	5	009100022



910A/SB17

6-7-8-9-10-11-12
13-14-15-16-17
18-19-20-21-22 mm

1 009100030

910B

bi-hex hand sockets

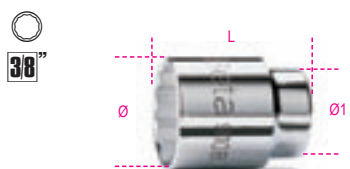

UNI/ISO 2725 DIN 3124

mm	Ø	L	Ø1		
6	9,5	28	16,7	5	009100106
7	10,7	28	16,7	5	009100107
8	12,1	28	16,7	5	009100108
9	13,2	28	16,7	5	009100109
10	14,6	29	16,7	5	009100110
11	15,8	29	16,7	5	009100111
12	17,2	30	17,7	5	009100112
13	18,4	31	17,0	5	009100113
14	19,7	32	17,5	5	009100114
15	20,9	32	18,0	5	009100115
16	22,2	33	18,5	5	009100116
17	23,2	33	19,0	5	009100117
18	24,7	34	20,0	5	009100118
19	25,8	35	21,0	5	009100119
20	27,2	35	22,0	5	009100120
21	28,2	36	23,0	5	009100121
22	29,7	37	24,0	5	009100122



910B/SB17

6-7-8-9-10-11-12
13-14-15-16-17
18-19-20-21-22 mm

1 009100130

Beta

910AL

hexagon hand sockets,
long series



UNI/ISO 2725 DIN 3124

mm	Ø	L	Ø1		
8	12,0	55	17	3	009100158
9	13,0	55	17	3	009100159
10	14,5	55	17	3	009100160
11	16,0	55	17	3	009100161
12	17,0	55	17	3	009100162
13	18,0	55	17	3	009100163
14	20,0	55	18	3	009100164
15	21,0	55	20	3	009100165
16	22,0	55	20	3	009100166
17	23,5	55	22	3	009100167
18	24,5	55	23	2	009100168
19	25,0	55	24	2	009100169
21	27,0	65	26	2	009100171
22	29,0	65	28	2	009100172



910AL/SB14

8-9-10-11-12-13-14
15-16-17-18-19-21-22 mm

1 009100174

910BL

bi-hex hand sockets, long series



UNI/ISO 2725 DIN 3124

mm	Ø	L	Ø1		
8	12,0	55	17	3	009100308
9	13,0	55	17	3	009100309
10	14,5	55	17	3	009100310
11	16,0	55	17	3	009100311
12	17,0	55	17	3	009100312
13	18,0	55	17	3	009100313
14	20,0	55	18	3	009100314
15	21,0	55	20	3	009100315
16	22,0	55	20	3	009100316
17	23,5	55	22	3	009100317
18	24,5	55	23	2	009100318
19	25,0	55	24	2	009100319
21	27,0	65	26	2	009100321
22	29,0	65	28	2	009100322



910BL/SB14

8-9-10-11-12-13
14-15-16-17-18
19-21-22 mm

1 009100340

910B/SN

swivel end bi-hex hand sockets

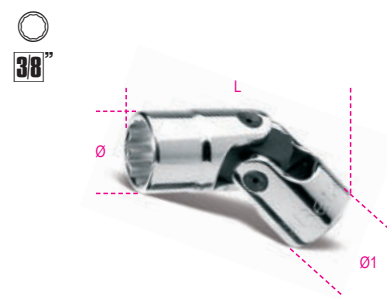

mm	Ø	L	Ø1		
10	14,5	48,5	19	2	009100230
11	15,8	49,5	19	2	009100231
12	17,0	50,0	19	2	009100232
13	18,3	51,0	19	2	009100233
14	19,5	51,0	19	2	009100234
15	20,8	53,5	19	2	009100235
16	22,0	53,5	19	2	009100236
17	23,3	54,5	19	2	009100237
18	24,5	54,5	19	2	009100238
19	25,8	56,5	19	2	009100239

910A/AS

hexagon hand sockets

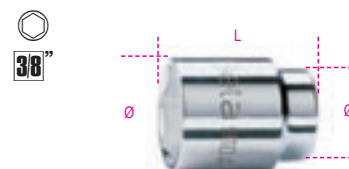

"	Ø	L	Ø1		
1/4	10,3	26	17,3	5	009100276
5/16	11,9	26	17,3	5	009100278
11/32	13,3	26	17,3	5	009100279
3/8	13,9	26	17,3	5	009100280
7/16	15,8	26	17,3	5	009100281
1/2	17,9	26	17,3	5	009100283
9/16	19,5	27	18,5	5	009100284
19/32	20,6	27	19,5	5	009100285
5/8	21,9	28	20,0	5	009100286
11/16	24,6	30	22,5	5	009100287
3/4	25,9	30	23,5	5	009100289
13/16	27,9	32	26,0	5	009100291
7/8	29,6	32	26,5	5	009100292



910A-AS/SB13

1/4-5/16-11/32-3/8-7/16
1/2-9/16-19/32-5/8-11/16
3/4-13/16-7/8

1 009100295

910AS

bi-hex hand sockets

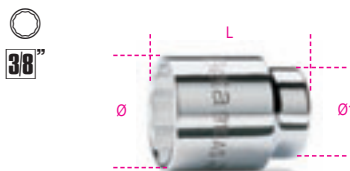

"	Ø mm	L mm	Ø1 mm	1	2
1/4	9,5	28	16,7	5	009100201
5/16	12,1	28	16,7	5	009100202
11/32	13,2	28	16,7	5	009100203
3/8	14,6	29	16,7	5	009100204
7/16	15,8	29	16,7	5	009100205
1/2	18,4	31	17,0	5	009100206
9/16	19,7	32	17,5	5	009100207
19/32	20,9	32	18,0	5	009100208
5/8	22,2	33	18,5	5	009100209
11/16	24,7	34	20,0	5	009100210
3/4	25,8	35	21,0	5	009100211
13/16	28,2	36	23,0	5	009100212
7/8	29,7	37	24,0	5	009100213



910AS/SB13	1	2
1/4-5/16-11/32-3/8-7/16	5	009100215
1/2-9/16-19/32-5/8-11/16		
3/4-13/16-7/8		

910AS/L

bi-hex hand sockets, long series

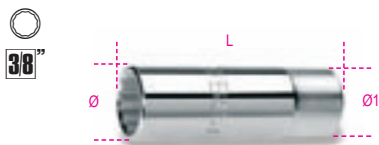

"	Ø mm	L mm	Ø1 mm	3	2
1/4	10	55	17	3	009100350
5/16	12	55	17	3	009100351
3/8	14	55	17	3	009100352
7/16	16	55	17	3	009100353
1/2	18	55	17	3	009100354
9/16	20	55	18	3	009100355
19/32	21	55	20	3	009100356
5/8	22	55	20	3	009100357
11/16	23	55	22	3	009100359
3/4	25	55	24	3	009100360
13/16	27	65	26	3	009100362
7/8	29	65	28	3	009100363



910ASL/SB12	1	2
1/4-5/16-3/8-7/16	3	009100365
1/2-9/16-19/32-5/8-11/16		
3/4-13/16-7/8		

910AS/SN

swivel end bi-hex hand sockets

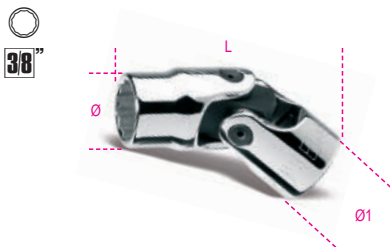

* SAE AS 954E

"	Ø mm	L mm	Ø1 mm	2	2
* 3/8	14,0	48,0	19	2	009100260
* 7/16	15,8	51,0	19	2	009100261
* 1/2	18,3	51,0	19	2	009100262
* 9/16	19,5	51,0	19	2	009100263
* 5/8	22,0	53,5	19	2	009100264
11/16	24,5	54,5	19	2	009100265
3/4	25,8	56,5	19	2	009100266

910FTX

hand sockets for Torx® head screws

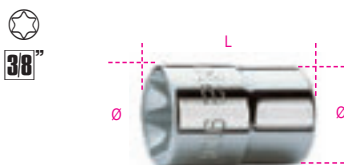

"	Ø mm	L mm	Ø1 mm	5	2
E4	6,2	26	17,3	5	009100404
E5	7,0	26	17,3	5	009100405
E6	8,3	26	17,3	5	009100406
E7	8,9	26	17,3	5	009100407
E8	9,9	26	17,3	5	009100408
E10	12,0	26	17,3	5	009100410
E12	14,5	26	17,3	5	009100412
E14	15,8	26	17,3	5	009100414
E16	18,0	26	17,3	5	009100416



910FTX/SB9	1	2
E4-E5-E6-E7-E8	5	009100430
E10-E12-14-E16		

910FTX/L

hand sockets for Torx® head screws, long series



"	Ø mm	L mm	Ø1 mm	3	2
E4	6,2	55	17,3	3	009100440
E5	7,0	55	17,3	3	009100441
E6	8,3	55	17,3	3	009100442
E7	8,9	55	17,3	3	009100443
E8	9,9	55	17,3	3	009100444
E10	12,0	55	17,3	3	009100445



910FTX-L/SB6	1	2
E4-E5-E6	3	009100449
E7-E8-E10		

910LP

socket drivers for slotted head screws



SxA mm	Ø mm	L mm	L1 mm	2	2
1x5,5	18,5	54	24	2	009100452
1,2x6,5	18,5	54	24	2	009100453
1,2x8	18,5	54	24	2	009100454
1,6x9	18,5	54	24	2	009100456

910PH

socket drivers for cross head Phillips® screws



PH	Ø mm	L mm	L1 mm	2	2
1	18,5	48	18	2	009100471
2	18,5	48	18	2	009100472
3	18,5	48	18	2	009100473
4	18,5	48	18	2	009100474

910PE

socket drivers for hexagon screws

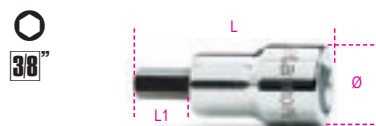

DIN 7422

mm	Ø mm	L mm	L1 mm	5	2
3	18,5	50	20	5	009100490
4	18,5	50	20	5	009100492
5	18,5	50	20	5	009100494
6	18,5	50	20	5	009100496
7	18,5	50	20	5	009100497
8	18,5	50	20	5	009100498
10	18,5	50	20	5	009100500



910PE/SB7	1	2
3-4-5-6-7-8-10 mm	5	009100503

910BP

ball head socket drivers for hexagon screws



mm	L mm	L1 mm	3	2
4L	92	62	3	009100584
5L	92	62	3	009100585
6L	92	62	3	009100586
7L	92	62	3	009100587
8L	92	62	3	009100588
10L	132	102	3	009100590

910ME

socket drivers for hexagon screws



mm	Ø mm	L mm	L1 mm		
4	18	62	15	5	009100504
5	18	62	15	5	009100505
6	18	62	15	5	009100506
7	18	62	15	5	009100507
8	19	62	15	5	009100508
10	20	62	15	5	009100510
12	20	62	15	5	009100512



910ME/SB5
4-5-6-8-10 mm

910PT

socket drivers for 5-star head screws

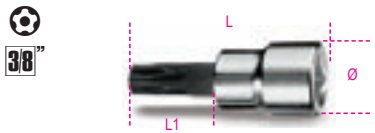

⊕	Ø mm	L mm	L1 mm		
PT40	20	50	20	3	009100540
PT45	20	50	20	3	009100545
PT50	20	50	20	3	009100550



910PT/SB8
PT10-PT15-PT20-PT25
PT30-PT40-PT45-PT50

910TX

socket drivers for Torx® head screws



⊕	Ø mm	L mm	L1 mm		
T15	18,5	50	20	5	009100519
T20	18,5	50	20	5	009100520
T25	18,5	50	20	5	009100521
T27	18,5	50	20	5	009100522
T30	18,5	50	20	5	009100523
T40	18,5	50	20	5	009100524



910TX/SB6
T15-T20-T25
T27-T30-T40

910CF

3/8" square drive crowfoot wrenches



mm	A mm	L mm		
10	21,3	32,3	2	009100135
11	23,1	34,3	2	009100136
12	25,5	36,2	2	009100137
13	26,9	37,4	2	009100138
14	30,2	40,0	2	009100139
15	33,3	41,3	2	009100140
16	33,3	41,3	2	009100141
17	38,1	46,5	2	009100142
18	38,1	46,5	2	009100143
19	39,6	48,0	2	009100144



910CF/SB10
10-11-12-13-14-15
16-17-18-19 mm

910/15

adaptor, 3/8" female
and 1/4" male drivers



UNI/ISO 3316 DIN 3123

L mm	Ø mm	□	■		
30	17,0	3/8	1/4	5	009100810



Always apply torque loads evenly
and progressively to avoid breakage
and any possible injury.

910/16

adaptor, 3/8" female
and 1/2" male drives



UNI/ISO 3316 DIN 3123

L mm	Ø mm	□	■		
32	18,0	3/8	1/2	5	009100814

910/20 - 910/21 - 910/22

3/8" drive extension bars

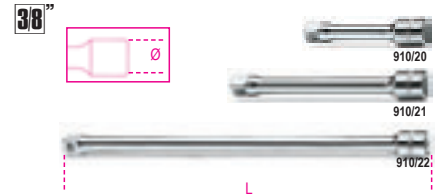

UNI/ISO 3316 DIN 3123

	L mm	Ø mm		
910/20	75	17	5	009100820
910/21	125	17	5	009100822
910/22	250	17	5	009100826

910AN

3/8" wobble extension bars

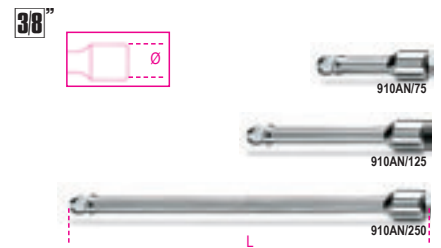

	L mm	Ø mm		
910AN/75	75	17	3	009100827
910AN/125	125	17	3	009100828
910AN/250	250	17	3	009100829

910/25

3/8" drive universal joint



UNI/ISO 3316 DIN 3123

L mm	Ø mm		
54,6	19	5	009100830

910M/35

3/8" swivel drive with metal handle



UNI/ISO 3315 DIN 3122

L mm			
250	3	009100839	

910/36A

3/8" drive swivel handle

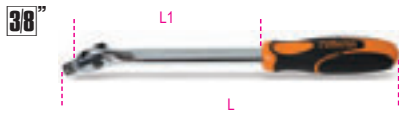

UNI/ISO 3315 DIN 3122

L	L1	
mm	mm	
255	154	3 009100845

910/40

3/8" drive swivel T-handle



L	L1	
mm	mm	
420	175	3 009100850

910/42

3/8" drive sliding T-handle

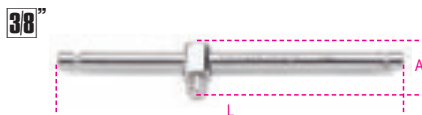

UNI/ISO 3315 DIN 3122

L	A	
mm	mm	
210	30,5	5 009100854

910/46

3/8" square drive with speed brace

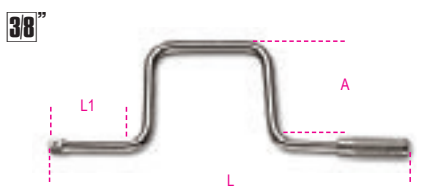

UNI/ISO 3315 DIN 3122

L	L1	A	
mm	mm	mm	
315	80	115	1 009100862

910/55

3/8" drive reversible ratchet 72 teeth



UNI/ISO 3315 DIN 3122

L	Ø	A	
mm	mm	mm	
200	30	33	3 009100882

910/55Q

3/8" drive reversible ratchet 48 teeth



UNI/ISO 3315 DIN 3122

L	Ø	A	
mm	mm	mm	
200	30	33	3 009100885

910M/55

3/8" drive reversible ratchet with metal handle



L	Ø	A	
mm	mm	mm	
178	30	26	2 009100875

910M/56

3/8" drive reversible swivel ratchet with metal handle



L	Ø	A	
mm	mm	mm	
265	31	29	2 009100887

910/58

3/8" drive reversible ratchet with rotating handle, 52 tooth mechanism

- Socket release button
- Ring nut reversal system on ratchet head
- Bi-material handle



L	Ø	A	
mm	mm	mm	
222	37	38,5	1 009100884

Spare parts rotating mechanism of ratchets, see table after item 929/C8

910.../C10

10 sockets and 2 accessories



910A/C10 1 009100909

910A	6 - 7 - 8 - 10 - 11 - 12
910/21	13 - 14 - 17 - 19 mm
910/55	125 mm
270x120x45 mm - 1,3 kg	

910B/C10 1 009100910

910B	6 - 7 - 8 - 10 - 11 - 12
910/21	13 - 14 - 17 - 19 mm
910/55	125 mm
270x120x45 mm - 1,3 kg	

910A/C16...

16 hexagon sockets and 5 accessories



910A/C16 1 009100936

910A	6 - 7 - 8 - 9 - 10 - 11 - 12 - 13
910/21	14 - 15 - 16 - 17 - 18 - 19
910/22	21 - 22 mm
910/25	125 mm
910/42	250 mm
910/55	21 - 22 mm
335x145x60 mm - 2,3 kg	

910A/C16Q 1 009100932

910A	6 - 7 - 8 - 9 - 10 - 11 - 12 - 13
910/21	14 - 15 - 16 - 17 - 18 - 19
910/22	21 - 22 mm
910/25	125 mm
910/42	250 mm
910/55Q	21 - 22 mm
335x145x60 mm - 2,3 kg	

910B/C16...

16 bi-hex sockets and 5 accessories

38"



910B/C16

1 009100937

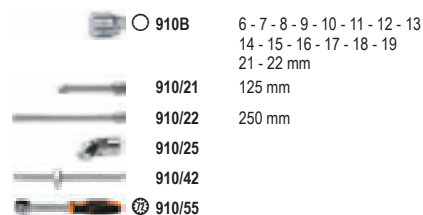

335x145x60 mm - 2,3 kg

910B/C16Q

1 009100933

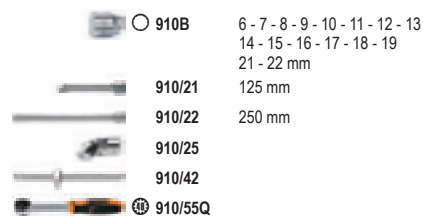

335x145x60 mm - 2,3 kg

910A/C17

17 hexagon sockets and 9 accessories

38"



910A/C17

1 009100938

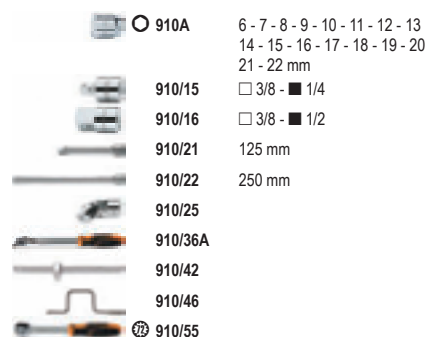

420x280x60 mm - 4,0 kg

910.../C29

17 sockets, 12 socket drivers and 5 accessories

38"



910A/C29

1 009100944

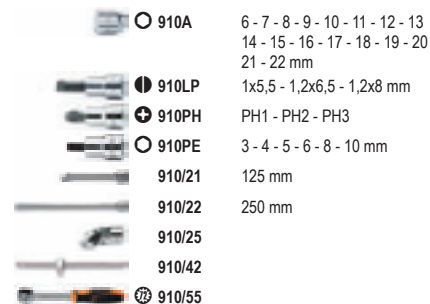

420x185x60 mm - 3,5 kg

910B/C29

1 009100945

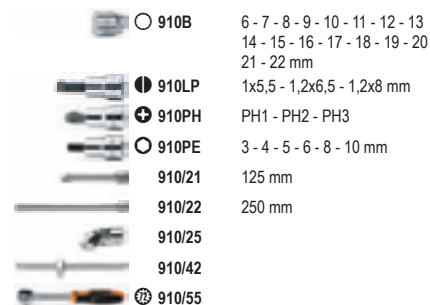

420x185x60 mm - 3,5 kg

910AS/C13...

13 bi-hex sockets and 5 accessories

38"



910AS/C13

1 009100925

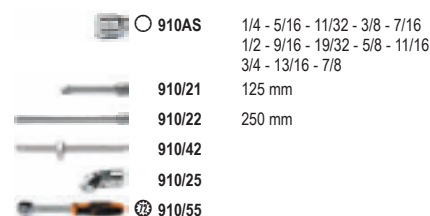

335x145x60 mm - 2,3 kg

910AS/MBM-C18

13 bi-hex sockets and 5 accessories for aeronautical maintenance

38"



910AS/MBM-C18

1 009100926

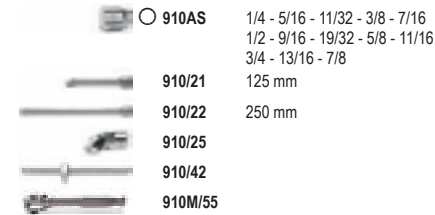

335x145x60 mm - 2,5 kg

910A/C16HR

16 hexagon sockets and 5 accessories

38"



910A/C16HR

1 009100935

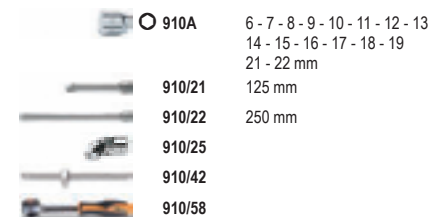

335x145x60 mm - 2,4 kg

920A

hexagon hand sockets

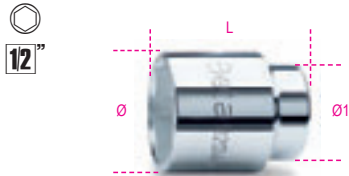

UNI/ISO 2725 DIN 3124

mm	Ø	L	Ø1		
8	12,4	38	21,7	10	009200008
9	13,5	38	21,7	10	009200009
10	14,9	38	21,7	10	009200010
11	16,1	38	21,7	10	009200011
12	17,5	38	21,7	10	009200012
13	18,7	38	21,7	10	009200013
14	20,1	38	21,7	10	009200014
15	21,5	38	22,5	10	009200015
16	22,7	38	23,7	10	009200016
17	24,1	38	23,1	10	009200017
18	25,3	39	24,0	10	009200018
19	26,6	39	24,0	10	009200019
20	27,8	40	25,0	5	009200020
21	28,8	40	25,0	5	009200021
22	29,9	41	26,0	5	009200022
23	30,8	42	26,0	5	009200023
24	32,2	43	27,0	5	009200024
25	33,2	44	27,0	5	009200025
26	34,7	45	28,0	5	009200026
27	36,2	46	29,0	5	009200027
28	37,2	47	30,0	5	009200028
29	38,6	48	31,0	5	009200029
30	40,2	48	32,0	5	009200030
32	42,3	49	34,0	5	009200032



920A/SB13
10-11-12-13-14-15-16
17-18-19-20-21-22 mm



920A/SB8
23-24-25-26-27-28-30-32 mm

920B

bi-hex hand sockets

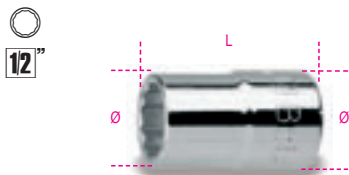

UNI/ISO 2725 DIN 3124

mm	Ø	L	Ø1		
8	12,4	38	21,7	10	009200108
9	13,5	38	21,7	10	009200109
10	14,9	38	21,7	10	009200110
11	16,1	38	21,7	10	009200111
12	17,5	38	21,7	10	009200112
13	18,7	38	21,7	10	009200113
14	20,1	38	21,7	10	009200114
15	21,5	38	22,5	10	009200115
16	22,7	38	23,7	10	009200116
17	24,1	38	23,1	10	009200117

mm	Ø	L	Ø1		
18	25,3	39	24,0	10	009200118
19	26,6	39	24,0	10	009200119
20	27,8	40	25,0	5	009200120
21	28,8	40	25,0	5	009200121
22	29,9	41	26,0	5	009200122
23	30,8	42	26,0	5	009200123
24	32,2	43	27,0	5	009200124
25	33,2	44	27,0	5	009200125
26	34,7	45	28,0	5	009200126
27	36,2	46	29,0	5	009200127
28	37,2	47	30,0	5	009200128
29	38,6	48	31,0	5	009200129
30	40,2	48	32,0	5	009200130
32	42,3	49	33,9	5	009200132



920B/SB13
10-11-12-13-14-15-16
17-18-19-20-21-22 mm



920B/SB8
23-24-25-26-27
28-30-32 mm

920AL

hexagon hand sockets,
long series



UNI/ISO 2725 DIN 3124

mm	Ø	L	Ø1		
10	14,7	77	21	5	009200626
12	17,8	77	21	5	009200627
13	19,0	77	22	5	009200628
14	20,3	77	22	5	009200629
15	21,5	77	22	5	009200630
16	22,8	77	22	5	009200631
17	24,0	77	23	5	009200632
18	25,0	77	24	5	009200633
19	26,5	77	25	5	009200634
21	29,0	77	27	5	009200635
22	30,0	77	28	5	009200636
23	31,5	77	29	5	009200637
24	32,8	77	30	5	009200638
27	36,5	77	33	3	009200639
30	40,0	77	36	3	009200640
32	42,8	77	38	3	009200641
36	48,0	77	41	3	009200642



920AL/SB11
10-12-13-14-15-16
17-18-19-21-22 mm

920BL

bi-hex hand sockets, long series

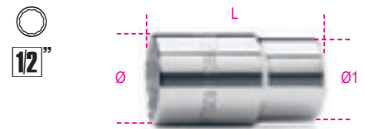

UNI/ISO 2725 DIN 3124

mm	Ø	L	Ø1		
10	14,7	77	21	5	009200310
12	17,8	77	21	5	009200312
13	19,0	77	22	5	009200313
14	20,3	77	22	5	009200314
15	21,5	77	22	5	009200315
16	22,8	77	22	5	009200316
17	24,0	77	23	5	009200317
18	25,0	77	24	5	009200318
19	26,5	77	25	5	009200319
21	29,0	77	27	5	009200321
22	30,0	77	28	5	009200322
23	31,5	77	29	5	009200323
24	32,8	77	30	5	009200324
27	36,5	77	33	3	009200327
30	40,0	77	36	3	009200330
32	42,8	77	38	3	009200332
36	48,0	77	41	3	009200336



920BL/SB11
10-12-13-14-15-16-17-18
19-21-22 mm

920A/AS

hexagon hand sockets

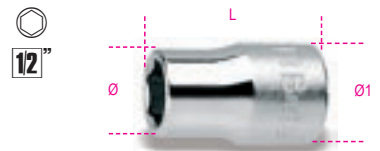

"	Ø	L	Ø1		
3/8	14,6	37	21	2	009200270
7/16	16,5	37	21	3	009200272
1/2	19,0	37	22	3	009200273
9/16	20,3	37	22	3	009200274
19/32	21,0	37	22	3	009200275
5/8	22,8	37	22	3	009200276
11/16	25,0	37	24	3	009200277
3/4	26,5	38	25	3	009200279
25/32	28,0	38	26	3	009200280
13/16	29,0	38	27	3	009200281
7/8	30,0	40	28	3	009200282
15/16	32,8	42	30	3	009200284
1	35,0	42	32	3	009200285
1.1/16	36,5	43	33	2	009200287
1.1/8	39,0	43	35	2	009200289
1.3/16	41,0	46	36	2	009200290
1.1/4	42,8	46	38	2	009200292



920A-AS/SB11
3/8-7/16-1/2-9/16-5/8
11/16-3/4-13/16-7/8
15/16-1

920AS

bi-hex hand sockets

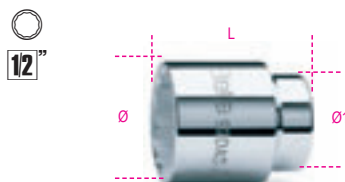

"	Ø mm	L mm	Ø1 mm		
3/8	14,9	38	21,7	3	009200201
7/16	16,1	38	21,7	3	009200202
1/2	18,7	38	21,7	3	009200203
9/16	20,1	38	21,7	3	009200204
5/8	22,7	38	22,5	3	009200206
19/32	21,5	38	23,7	3	009200207
11/16	25,3	39	24,0	3	009200208
3/4	26,6	39	24,0	3	009200209
25/32	27,8	40	25,0	3	009200210
13/16	28,8	40	25,0	3	009200211
7/8	29,9	41	26,0	3	009200212
15/16	32,2	43	27,0	3	009200214
1	34,2	45	28,0	3	009200216
1.1/16	36,2	46	29,0	2	009200217
1.1/8	38,6	48	31,0	2	009200218
1.3/16	40,2	48	32,0	2	009200219
1.1/4	42,3	49	33,5	2	009200220



920AS/SB11

3/8-7/16-1/2-9/16-5/8
11/16-3/4-13/16-7/8
15/16-1

1 009200225

920AS/L

bi-hex hand sockets, long series



"	Ø mm	L mm	Ø1 mm		
1/2	19,0	77	22	2	009200352
9/16	20,3	77	22	2	009200353
5/8	22,8	77	22	2	009200355
11/16	25,0	77	24	2	009200357
3/4	26,5	77	25	2	009200358
13/16	29,0	77	27	2	009200360
7/8	30,0	77	28	2	009200361
15/16	32,8	77	30	2	009200362
1	35,0	77	32	2	009200363
1.1/16	36,5	77	33,0	2	009200364
1.1/8	37,8	77	34	2	009200365



920ASL/SB11

1/2-9/16-5/8-11/16
3/4-13/16-7/8-15/16
1-1.1/8-1.1/16

1 009200369

920FTX

hand sockets for Torx® head screws

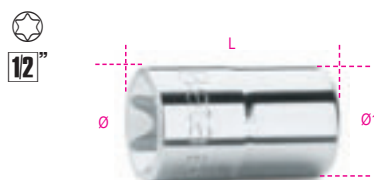

"	Ø mm	L mm	Ø1 mm		
E10	13,2	36	21	5	009200380
E12	15,0	37	21	5	009200381
E14	16,3	37	21	5	009200382
E16	18,8	37	22	5	009200383
E18	20,4	37	22	5	009200384
E20	22,9	37	22	5	009200385
E22	25,0	37	24	3	009200387
E24	26,5	40	25	3	009200388



920FTX/SB6

E10-E12-E14
E16-E18-E20

1 009200390



920FTX/C8

E10-E12-E14-E16
E18-E20-E22-E24

1 009200391

270X120X45 mm - 1 kg

920FTX/L

hand sockets for Torx® head screws,
long series



"	Ø mm	L mm	Ø1 mm		
E10	13,2	77	21,0	5	009200400
E12	15,0	77	21,0	5	009200401
E14	16,3	77	21,0	5	009200402
E16	18,8	77	21,8	3	009200403
E18	20,4	77	21,8	3	009200404
E20	22,9	77	22,0	3	009200405



920FTX-LSB6

E10-E12-E14
E16-E18-E20

1 009200409

920LP

socket drivers for slotted head screws

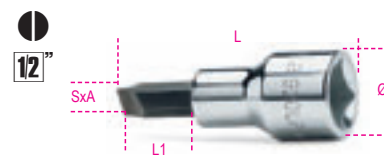

SxA mm	Ø mm	L mm	L1 mm		
1x5,5	22,5	62	24	3	009200452
1,2x6,5	22,5	62	24	3	009200453
1,2x8	22,5	62	24	3	009200454
1,6x9	22,5	62	24	3	009200456
2x12	22,5	62	24	3	009200458

920PH

socket drivers for cross head Phillips® screws



PH	Ø mm	L mm	L1 mm		
1	22,5	56	18	3	009200471
2	22,5	56	18	3	009200472
3	22,5	56	18	3	009200473
4	22,5	56	18	3	009200474

920LH/SB7

socket drivers for cross head
Phillips® screws



920LH/SB7

920LP 1,2x6,5 - 1,2x8
1,6x9 - 2x12 mm
920PH PH2 - PH3 - PH4

1 009200478

920PE

socket drivers for hexagon screws

12"

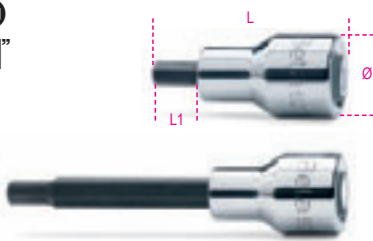

DIN 7422

mm	Ø mm	L mm	L1 mm	12"
3	22,5	58	20	5 009200410
4	22,5	58	20	5 009200412
5	22,5	58	20	5 009200414
5L	22,5	100	62	5 009200415
6	22,5	58	20	5 009200417
6L	22,5	100	62	5 009200418
7	22,5	58	20	5 009200420
7L	22,5	100	62	5 009200421
8	22,5	58	20	5 009200423
8L	22,5	100	62	5 009200424
9	22,5	58	20	5 009200425
9L	22,5	140	102	5 009200426
10	22,5	58	20	5 009200428
10L	22,5	140	102	5 009200429
12	23,0	58	20	5 009200432
12L	22,5	140	102	5 009200433
14	23,0	58	20	5 009200434
14L	22,5	140	102	5 009200435
17	29,5	60	22	5 009200437
19	29,5	60	22	5 009200439

12"



920PE/SB9
4-5-6-8-10 mm
5L-6L-8L-10L mm

12"



920PE/C10
4-5-6-7-8-10
12-14-17-19 mm
270X120X45 mm - 1,5 kg

920PE/AS

socket drivers for hexagon screws

12"



"	Ø mm	L mm	L1 mm	12"
1/8	22,5	58	20	2 009200460
3/16	22,5	58	20	2 009200461
1/4	22,5	58	20	2 009200463
3/8	22,5	58	20	2 009200464
1/2	22,5	60	20	2 009200465
3/4	22,5	60	20	1 009200468

920BP

ball head socket drivers
for hexagon screws

12"

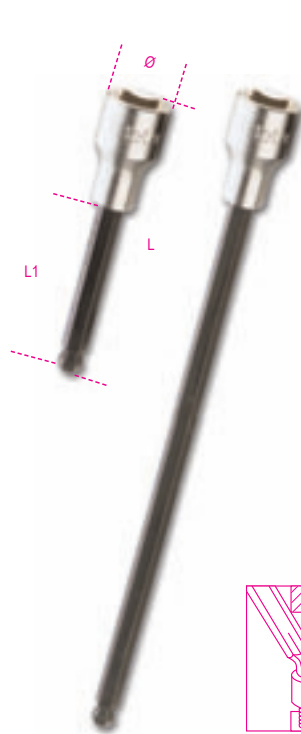

mm	Ø mm	L mm	L1 mm	12"
5L	22,5	100	62	5 009200490
5XL	22,5	240	202	1 009200495
6L	22,5	100	62	5 009200491
6XL	22,5	240	202	1 009200496
7L	22,5	100	62	5 009200492
8L	22,5	100	62	5 009200493
8XL	22,5	240	202	1 009200497
10L	22,5	140	102	5 009200494

12"



920BP/SB8
5L-6L-7L-8L-10L mm
5XL-6XL-8XL mm

920ME

socket drivers for hexagon screws

12"



mm	Ø mm	L mm	L1 mm	12"
5	21	75	15,5	5 009200505
6	21	75	15,5	5 009200506
7	21	75	15,5	5 009200507
8	21	75	15,5	5 009200508
10	23	75	15,5	5 009200510
12	24	75	15,5	5 009200512
14	24	75	15,5	5 009200514
17	24	75	15,5	5 009200517

12"



920ME/SB7
5-6-8-10-12-14-17 mm

12"



920ME/C7
5-6-8-10-12-14-17 mm
250X100X35 mm - 1,4 kg

920TX

socket drivers for Torx® head screws

12"

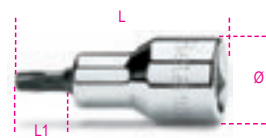

"	Ø mm	L mm	L1 mm	12"
T20	22,5	58	20	5 009200520
T20L	22,5	120	82	3 009200530
T25	22,5	58	20	5 009200521
T25L	22,5	120	82	3 009200531
T27	22,5	58	20	5 009200522
T27L	22,5	120	82	3 009200533
T30	22,5	58	20	5 009200523
T30L	22,5	120	82	3 009200534
T40	22,5	58	20	5 009200524
T40L	22,5	120	82	3 009200535
T45	22,5	58	20	5 009200525
T45L	22,5	120	82	3 009200537
T50	22,5	58	20	5 009200526
T50L	23,0	140	102	3 009200538
T55	23,0	58	20	3 009200527
T55L	23,0	140	102	3 009200539
T60	23,0	58	20	3 009200528
T60L	23,0	140	102	3 009200540
T70L	23,0	120	82	3 009200541

12"



920TX-SB9
T20-T25-T27-T30
T40-T45-T50-T55-T60



920TX-L/SB10
T20L-T25L-T27L-T30L-T40L-
T45L-T50L-T55L-T60L-T70L

12"



920TX/C9
T20-T25-T27-T30-T40
T45-T50-T55-T60
270X120X45 mm - 1,2 kg

920RTX

socket drivers
for Tamper Resistant Torx® head screws

12"



	Ø mm	L mm	L1 mm		
T20	22,5	58	20	5	009200370
T25	22,5	58	20	5	009200371
T27	22,5	58	20	5	009200372
T30	22,5	58	20	5	009200373
T40	22,5	58	20	5	009200374

12"



920RTX/SB5
T20-T25-T27-T30-T40

920XZN

socket drivers with XZN® profile

12"

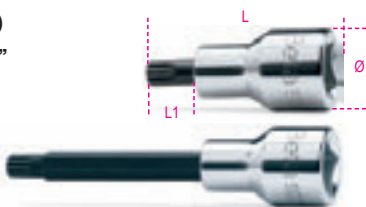

DIN 2324

	Ø mm	L mm	L1 mm		
M4	22,5	58	20	3	009200559
M5	22,5	58	20	3	009200560
M6	22,5	58	20	3	009200561
M6L	22,5	100	62	3	009200562
M8	22,5	58	20	3	009200563
M8L	22,5	100	62	3	009200564
M9	22,5	58	20	3	009200582
M9L	22,5	100	62	3	009200583
M10	22,5	58	20	3	009200565
M10L	22,5	100	62	3	009200566
M12	22,5	58	20	3	009200568
M12L	22,5	100	62	3	009200569
M14	23,0	58	20	3	009200571
M14L	23,0	100	62	3	009200572
M16	23,0	58	20	3	009200573
M18	23,0	58	20	3	009200574

12"



920XZN/SB7
M4-M5-M6-M8
M10-M12-M14

12"



920XZN/SB12
M5-M6-M8-M10-M12
M14-M16-M6L-M8L
M10L-M12L-M14L

12"



920XZN-L/S5
M6L-M8L-M10L
M12L-M14L

920ES

special form socket drivers

12"



UNI 9326

Ø mm		L mm	L1 mm		
7	(6R)	58	20	5	009200587
7XL	(6R)	240	202	1	009200607
9	(8R)	58	20	5	009200589
9XL	(8R)	240	202	1	009200609
10	(8S)	58	20	5	009200590
10XL	(8S)	240	202	1	009200610
11	(10R)	58	20	5	009200591
11XL	(10R)	240	202	1	009200611
12L	(10S)	100	62	3	009200592
12XL	(10S)	240	202	1	009200612
14L	(12S)	100	62	3	009200594
14XL	(12S)	240	202	1	009200614
16L	(14R)	100	62	3	009200596
16XL	(14R)	240	202	1	009200616

12"



920ES/SB7
7-9-10-11-12L-14L-16L

12"



920ES-XL/SB7
7XL-9XL-10XL-11XL
12XL-14XL-16XL

920/15

adaptor, 1/2" female
and 3/8" male drives

12"



UNI/ISO 3316 DIN 3123

L mm	□	■	Ø mm		
42	1/2	3/8	22,0	5	009200810



Always apply torque loads evenly
and progressively to avoid breakage
and any possible injury.

920/16

adaptor, 1/2" female
and 3/4" male drives

12"



UNI/ISO 3316 DIN 3123

L mm	□	■	Ø mm		
46	1/2	3/4	26	5	009200814

920/20÷920/23

1/2" drive extension bars

12"



UNI/ISO 3316 DIN 3123

	L mm	Ø mm		
920/20	75	22	5	009200818
920/21	125	22	5	009200822
920/22	255	22	5	009200826
920/23	375	22	2	009200827

920AN

1/2" wobble extension bars

12"

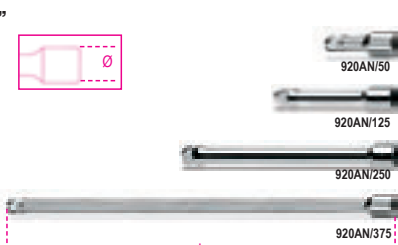

	L mm	Ø mm		
920AN/50	50	22	5	009200833
920AN/125	125	22	5	009200834
920AN/250	250	22	3	009200835
920AN/375	375	22	3	009200836



920/25

1/2" drive universal joint

12"



UNI/ISO 3316 DIN 3123

L	Ø		
mm	mm		
75	27	5	009200830

920/35A

1/2" drive swivel handle

12"



UNI/ISO 3315 DIN 3122

L	L1		
mm	mm		
285	160	3	009200846

920M/35

1/2" swivel drive with metal handle

12"



UNI/ISO 3315 DIN 3122

L			
mm			
380		2	009200845

920M/35L

1/2" swivel drive with metal handle, long series

12"



L
mm
600

		1	009200843



Always apply torque loads evenly and progressively to avoid breakage and any possible injury.

920/36A

1/2" drive swivel handle

12"

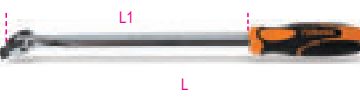

UNI/ISO 3315 DIN 3122

L	L1		
mm	mm		
408	283	2	009200847

920/38

1/2" extension drive swivel handle

12"



L	L max		
mm	mm		
262	402	1	009200839

920/40

1/2" drive swivel T-handle

12"



L	L1		
mm	mm		
490	230	2	009200850

920/42

1/2" drive sliding T handle

12"

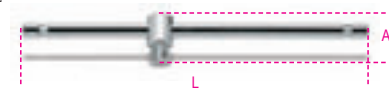

L	A		
mm	mm		
305	42	5	009200854

920/44

1/2" drive offset handle

12"



L	L1		
mm	mm		
230	60	3	009200858

920/46

1/2" drive with speed brace

12"



L	L1	A		
mm	mm	mm		
385	110	160	1	009200862

920/50

1/2" push-through drive ratchet, 72 teeth

72

12"



UNI/ISO 3315 DIN 3122

L	Ø	A		
mm	mm	mm		
275	40	42	3	009200871

920/50F

1/2" female square drive ratchet, 72 teeth

72

12"



UNI/ISO 3315 DIN 3122

L	Ø	A		
mm	mm	mm		
275	40	27	2	009200889

920/55

1/2" drive reversible ratchet, 72 teeth

72

12"



UNI/ISO 3315 DIN 3122

L	Ø	A		
mm	mm	mm		
275	40	43	3	009200882

920/55Q

1/2" drive reversible ratchet, 48 teeth

48

12"



UNI/ISO 3315 DIN 3122

L	Ø	A		
mm	mm	mm		
275	40	43	3	009200885

920/55X

1/2" drive reversible ratchet, 72 teeth



UNI/ISO 3315 DIN 3122

L	Ø	A		
mm	mm	mm		
200	30	33	3	009200895

920/55LC

1/2" drive reversible ratchet
"Locking System", 72 teeth

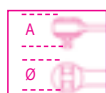

UNI/ISO 3315 DIN 3122

L	Ø	A		
mm	mm	mm		
275	40	43	2	009200896

920/55L

extension reversible ratchet,
1/2" male drive,
72 tooth mechanism



L	L max	Ø	A		
mm	mm	mm	mm		
282	422	40	43	1	009200927

920M/55

1/2" drive reversible ratchet
with metal handle



L	Ø	A		
mm	mm	mm		
253	38	35	1	009200893

920/56A

1/2" drive swivel reversible ratchet,
72 teeth



L	Ø	A		
mm	mm	mm		
315	40	43	1	009200911

920M/56

1/2" drive reversible swivel ratchet
with metal handle



L	Ø	A		
mm	mm	mm		
330	38	35,7	2	009200894

920/58

1/2" drive reversible ratchet
with rotating handle,
52 tooth mechanism

- Socket release button
- Ring nut reversal system on ratchet head
- Bi-material handle



L	Ø	A		
mm	mm	mm		
281	42,5	45	1	009200926

Spare parts
rotating mechanism of ratchets,
see table after item 929/C8

920.../C11

11 sockets and 2 accessories



920A/C11 1 009200921

920A	10 - 12 - 13 - 14 - 15 - 16 17 - 18 - 19 - 21 - 22 mm
920/22	255 mm
920/50	
335x145x60 mm - 2,5 kg	

920B/C11 1 009200922

920B	10 - 12 - 13 - 14 - 15 - 16 17 - 18 - 19 - 21 - 22 mm
920/22	255 mm
920/50	
335x145x60 mm - 2,5 kg	

920.../C12...

12 sockets and 5 accessories











920A/C12X 1 009200933

920A	10 - 11 - 12 - 13 - 14 - 17 - 19 22 - 24 - 27 - 30 - 32 mm
920/21	125 mm
920/22	255 mm
920/25	
920/42	
920/55	
420x185x60 mm - 4,2 kg	







920A/C12 1 009200931

920A	10 - 11 - 12 - 13 - 14 - 17 - 19 22 - 24 - 27 - 30 - 32 mm
920/21	125 mm
920/22	255 mm
920/25	
920/42	
920/50	
420x185x60 mm - 4,2 kg	

920B/C12X 1 009200934

-  **920B** 10 - 11 - 12 - 13 - 14 - 17 - 19
22 - 24 - 27 - 30 - 32 mm
 -  **920/21** 125 mm
 -  **920/22** 255 mm
 -  **920/25**
 -  **920/42**
 -  **920/55**
-  420x185x60 mm -  4,0 kg









920B/C12 1 009200932

-  **920B** 10 - 11 - 12 - 13 - 14 - 17 - 19
22 - 24 - 27 - 30 - 32 mm
 -  **920/21** 125 mm
 -  **920/22** 255 mm
 -  **920/25**
 -  **920/42**
 -  **920/50**
-  420x185x60 mm -  4,0 kg









920.../C20...
20 sockets and 5 accessories











920A/C20X 1 009200950

-  **920A** 10 - 11 - 12 - 13 - 14 - 15 - 16
17 - 18 - 19 - 20 - 21 - 22 - 23
24 - 26 - 27 - 28 - 30 - 32 mm
 -  **920/21** 125 mm
 -  **920/22** 255 mm
 -  **920/25**
 -  **920/42**
 -  **920/55**
-  420x185x60 mm -  5,1 kg









920A/C20 1 009200948

-  **920A** 10 - 11 - 12 - 13 - 14 - 15 - 16
17 - 18 - 19 - 20 - 21 - 22 - 23
24 - 26 - 27 - 28 - 30 - 32 mm
 -  **920/21** 125 mm
 -  **920/22** 255 mm
 -  **920/25**
 -  **920/42**
 -  **920/50**
-  420x185x60 mm -  5,1 kg









920A/C20Q 1 009200955

-  **920A** 10 - 11 - 12 - 13 - 14 - 15 - 16
17 - 18 - 19 - 20 - 21 - 22 - 23
24 - 26 - 27 - 28 - 30 - 32 mm
 -  **920/21** 125 mm
 -  **920/22** 255 mm
 -  **920/25**
 -  **920/42**
 -  **920/55Q**
-  420x185x60 mm -  5,1 kg

920B/C20 1 009200949

-  **920B** 10 - 11 - 12 - 13 - 14 - 15 - 16
17 - 18 - 19 - 20 - 21 - 22 - 23
24 - 26 - 27 - 28 - 30 - 32 mm
 -  **920/21** 125 mm
 -  **920/22** 255 mm
 -  **920/25**
 -  **920/42**
 -  **920/50**
-  420x185x60 mm -  5,0 kg

920B/C20X 1 009200951

-  **920B** 10 - 11 - 12 - 13 - 14 - 15 - 16
17 - 18 - 19 - 20 - 21 - 22 - 23
24 - 26 - 27 - 28 - 30 - 32 mm
 -  **920/21** 125 mm
 -  **920/22** 255 mm
 -  **920/25**
 -  **920/42**
 -  **920/55**
-  420x185x60 mm -  5,0 kg

920.../C21...
21 sockets and 6 accessories











920A/C21 1 009200952

-  **920A** 10 - 11 - 12 - 13 - 14 - 15 - 16
17 - 18 - 19 - 20 - 21 - 22 - 23
24 - 25 - 26 - 27 - 28 - 30 - 32 mm
 -  **920/21** 125 mm
 -  **920/22** 255 mm
 -  **920/25**
 -  **920/42**
 -  **920/46**
 -  **920/50**
-  420x280x60 mm -  6,5 kg









920A/C21X 1 009200983

-  **920A** 10 - 11 - 12 - 13 - 14 - 15 - 16
17 - 18 - 19 - 20 - 21 - 22 - 23
24 - 25 - 26 - 27 - 28 - 30 - 32 mm
 -  **920/21** 125 mm
 -  **920/22** 255 mm
 -  **920/25**
 -  **920/42**
 -  **920/46**
 -  **920/55**
-  420x280x60 mm -  6,4 kg

920B/C21 1 009200953

-  **920B** 10 - 11 - 12 - 13 - 14 - 15 - 16
17 - 18 - 19 - 20 - 21 - 22 - 23
24 - 25 - 26 - 27 - 28 - 30 - 32 mm
 -  **920/21** 125 mm
 -  **920/22** 255 mm
 -  **920/25**
 -  **920/42**
 -  **920/46**
 -  **920/50**
-  420x280x60 mm -  6,4 kg

920B/C21X 1 009200984

-  **920B** 10 - 11 - 12 - 13 - 14 - 15 - 16
17 - 18 - 19 - 20 - 21 - 22 - 23
24 - 25 - 26 - 27 - 28 - 30 - 32 mm
 -  **920/21** 125 mm
 -  **920/22** 255 mm
 -  **920/25**
 -  **920/42**
 -  **920/46**
 -  **920/55**
-  420x280x60 mm -  6,4 kg



920B/C30Q

30 bi-hex sockets and 5 accessories

12"



920B/C30Q

1 009200975

	○ 920B	8 - 9 - 10 - 11 - 12 - 13 - 14 15 - 16 - 17 - 18 - 19 - 20 - 21 22 - 23 - 24 - 26 - 27 - 30 mm
	○ 920BL	12 - 13 - 14 - 17 - 19 - 21 22 - 24 - 27 - 30 mm
	920/21	125 mm
	920/22	255 mm
	920/25	
	920/42	
	920/55Q	

420x280x60 mm - 7,6 kg

920.../C33

20 sockets, 13 socket drivers
and 5 accessories

12"



920A/C33

1 009200985

	○ 920A	10 - 11 - 12 - 13 - 14 - 15 - 16 17 - 18 - 19 - 20 - 21 - 22 - 23 24 - 26 - 27 - 28 - 30 - 32 mm
	● 920LP	1,2x8 - 1,6x9 - 2x12 mm
	⊕ 920PH	PH2 - PH3 - PH4
	○ 920PE	4 - 5 - 6 - 8 - 10 - 12 - 14 mm
	920/21	125 mm
	920/22	255 mm
	920/25	
	920/42	
	920/55	

420x280x60 mm - 6,7 kg

920B/C33

1 009200986

	○ 920B	10 - 11 - 12 - 13 - 14 - 15 - 16 17 - 18 - 19 - 20 - 21 - 22 - 23 24 - 26 - 27 - 28 - 30 - 32 mm
	● 920LP	1,2x8 - 1,6x9 - 2x12 mm
	⊕ 920PH	PH2 - PH3 - PH4
	○ 920PE	4 - 5 - 6 - 8 - 10 - 12 - 14 mm
	920/21	125 mm
	920/22	255 mm
	920/25	
	920/42	
	920/55	

420x280x60 mm - 6,7 kg

920/C37

37 bi-hex sockets and 5 accessories

12"



920/C37

1 009200988

	○ 920B	10 - 11 - 12 - 13 - 14 - 15 - 16 17 - 18 - 19 - 20 - 21 - 22 - 23 24 - 26 - 27 - 28 - 30 - 32 mm
	○ 920AS	3/8 - 7/16 - 1/2 - 9/16 - 19/32 5/8 - 11/16 - 3/4 - 25/32 - 13/16 7/8 - 15/16 - 1 - 1.1/16 - 1.1/8 1.3/16 - 1.1/4
	920/21	125 mm
	920/22	255 mm
	920/25	
	920/42	
	920/55	

420x280x60 mm - 7,5 kg

920AS/C10

10 bi-hex sockets and 2 accessories

12"



920AS/C10

1 009200919

	○ 920AS	3/8 - 7/16 - 1/2 - 9/16 - 5/8 11/16 - 3/4 - 13/16 - 7/8 - 15/16
	920/22	255 mm
	920/50	

335x145x60 mm - 2,6 kg

920AS/C15

15 bi-hex sockets and 6 accessories

12"



920AS/C15

1 009200947

	○ 920AS	3/8 - 7/16 - 1/2 - 9/16 - 5/8 - 11/16 3/4 - 13/16 - 7/8 - 15/16 - 1 1.1/16 - 1.1/8 - 1.3/16 - 1.1/4
	920/21	125 mm
	920/22	255 mm
	920/25	
	920/42	
	920/46	
	920/50	

420x280x60 mm - 5,9 kg

Beta

920AS/C17X

17 bi-hex sockets and 5 accessories

12"



920AS/C17X 1 009200942

	○ 920AS	3/8 - 7/16 - 1/2 - 9/16 - 19/32 - 5/8 11/16 - 3/4 - 25/32 - 13/16 - 7/8 15/16 - 1 - 1.1/16 - 1.1/8 - 1.3/16 - 1.1/4
	920/21	125 mm
	920/22	255 mm
	920/25	
	920/42	
	920/55	
420x185x60 mm - 4,8 kg		

920AS/MBM-C21

16 bi-hex sockets and 5 accessories for aeronautical maintenance

12"



920AS/MBM-C21 1 009200944

	○ 920AS	3/8 - 7/16 - 1/2 - 9/16 19/32 - 5/8 - 11/16 - 3/4 25/32 - 13/16 - 7/8 - 15/16 1 - 1.1/16 - 1.3/16 - 1.1/4
	920M/55	
	920/21	125 mm
	920/22	255 mm
	920/25	
	920/42	
420x185x60 mm - 5,0 kg		

920TX/C17

6 bits, 6 sockets, 5 socket drivers and 4 accessories for Torx® head screws



12"



920TX/C17 1 009200989

	861TX	T8 - T10 - T15 - T20 - T25 - T27
	897	
	920TX	T27 - T30 - T40 - T45 - T50
	920FTX	E10 - E12 - E14 - E16 - E18 - E20
	920/20	75 mm
	920/22	255 mm
	920/55	
420x185x60 mm - 2,9 kg		

920A/C17HR

17 hexagon sockets and 5 accessories in hard foam tray, in metal case

12"



920A/C17HR 1 009200939

	○ 920A	10-11-12-13-14-15-16-17-18-19-20- 21-22-24-27-30-32 mm
	920/21	125 mm
	920/22	255 mm
	920/25	
	920/42	
	920/58	
420x185x60 mm - 5,1 kg		

928A

hexagon hand sockets



3/4"



UNI/ISO 2725
DIN 3124

Ø	Ø	L	Ø1		
mm	mm	mm	mm		
19	29,2	50	34	5	009280019
22	31,3	53	34	5	009280022
23	33,3	53	34	5	009280023
24	34,5	53	34	5	009280024
26	36,8	55	35	5	009280026
27	38,0	56	35	5	009280027
28	39,0	57	35	3	009280028
29	40,2	58	35	3	009280029
30	41,5	58	37	3	009280030
32	44,3	60	37	3	009280032
33	45,8	60	37	3	009280033
34	46,8	60	37	3	009280034
35	48,1	62	38	3	009280035
36	49,5	64	38	3	009280036
38	52,0	68	40	3	009280038
41	56,0	71	40	3	009280041
46	62,3	75	43	3	009280046
50	67,4	80	43	3	009280050
55	73,7	84	48	1	009280055
60	80,0	87	48	1	009280060

928B

bi-hex hand sockets



3/4"

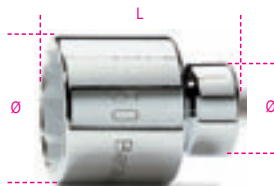

UNI/ISO 2725
DIN 3124

Ø	Ø	L	Ø1		
mm	mm	mm	mm		
19	29,2	50	34	5	009280119
22	31,3	53	34	5	009280122
23	33,3	53	34	5	009280123
24	34,5	53	34	5	009280124
26	36,8	55	35	5	009280126
27	38,0	56	35	5	009280127
28	39,0	57	35	3	009280128
29	40,2	58	35	3	009280129
30	41,5	58	37	3	009280130
32	44,3	60	37	3	009280132
33	45,8	60	37	3	009280133
34	46,8	60	37	3	009280134
35	48,1	62	38	3	009280135
36	49,5	64	38	3	009280136
38	52,0	68	40	3	009280138
41	56,0	71	40	3	009280141
46	62,3	75	43	3	009280146
50	67,4	80	43	3	009280150
55	73,7	84	48	1	009280155
60	80,0	87	48	1	009280160

928AS

hexagon hand sockets

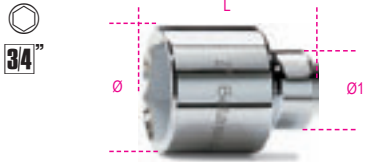

"	Ø mm	L mm	Ø1 mm		
7/8	32,0	53	34	1	009280202
15/16	34,5	53	34	1	009280203
1	36,2	55	35	1	009280204
1.1/16	38,0	56	35	1	009280205
1.1/8	40,2	58	35	1	009280206
1.1/4	44,2	60	37	1	009280208
1.5/16	45,8	60	37	1	009280209
1.3/8	48,1	62	38	1	009280210
1.7/16	49,5	64	38	1	009280211
1.1/2	52,0	68	40	1	009280212
1.5/8	56,0	71	40	1	009280214
1.11/16	58,8	74	40	1	009280215
1.13/16	62,3	75	43	1	009280217
1.7/8	65,0	78	43	1	009280218
2	68,3	80	43	1	009280219
2.1/16	71,5	83	48	1	009280220

928ME

socket drivers for hexagon screws

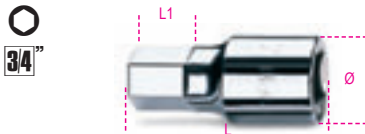

mm	Ø mm	L mm	L1 mm		
14	35	75	15,5	2	009280514
17	35	75	15,5	2	009280517
19	35	75	15,5	2	009280519
22	35	75	22,5	2	009280522

928/15

adaptor, 3/4" female and 1/2" male drives



UNI/ISO 3316
DIN 3123

L mm	Ø mm	□	■		
51,5	34	3/4	1/2	5	009280801



Always apply torque loads evenly and progressively to avoid breakage and any possible injury.

928/16

adaptor, 3/4" female and 1" male drives



UNI/ISO 3316

DIN 3123

L mm	Ø mm	□	■		
65	34	3/4	1"	5	009280807

928/20 - 928/21 - 928/22

3/4" drive extension bars

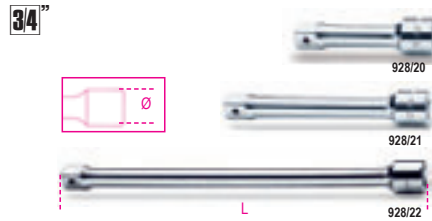

UNI/ISO 3316
DIN 3123

	L mm	Ø mm		
928/20	100	34	3	009280810
928/21	200	34	3	009280815
928/22	380	34	3	009280825

928/25

3/4" drive universal joint



UNI/ISO 3316 DIN 3123

L mm	Ø mm		
108	40	1	009280830

928/36A

3/4" drive swivel handle



L mm		
545	1	009280844

928/42

3/4" drive slide T-handle



UNI/ISO 3315 DIN 3122

L mm	A mm		
450	62,5	3	009280850

928/55

3/4" drive reversible ratchet, 72 teeth



L mm	Ø mm	A mm		
510	58	59	2	009280862

Spare parts
rotating mechanism of ratchets,
see table after item 929/C8

928.../C12

assortment of 12 hexagon hand sockets and 5 accessories in sheet metal case



928A/C12 1 009280955

928A	22 - 24 - 27 - 30 - 32 - 34 - 36 38 - 41 - 46 - 50 - 55 mm
928/21	200 mm
928/22	380 mm
928/25	
928/42	
928/55	

530x220x80 mm - 13,5 kg

928B/C12 1 009280957

928B	22 - 24 - 27 - 30 - 32 - 34 - 36 38 - 41 - 46 - 50 - 55 mm
928/21	200 mm
928/22	380 mm
928/25	
928/42	
928/55	

530x220x80 mm - 13,5 kg

928AS/C12

assortment of 12 hexagon hand sockets and 5 accessories in sheet metal case



928AS/C12 1 009280968

928AS	7/8-15/16-1.1/16-1.1/8-1.1/4 1.5/16-1.7/16-1.1/2-1.11/16 1.13/16-1.7/8-2.1/16
928/21	200 mm
928/22	380 mm
928/25	
928/42	
928/55	

530x220x80 mm - 13,5 kg

929

hexagon hand sockets



UNI/ISO 2725 DIN 3124

Ø mm	Ø mm	L mm	Ø1 mm	
36	49,5	65	48	1 009290036
41	56,0	70	48	1 009290041
46	62,0	75	48	1 009290046
50	67,5	80	48	1 009290050
55	74,0	85	54	1 009290055
60	80,0	90	54	1 009290060
65	86,0	95	54	1 009290065
70	92,0	100	60	1 009290070
75	99,0	110	60	1 009290075
80	106,0	120	60	1 009290080

929/15

adaptor, 1" female and 3/4" male drives

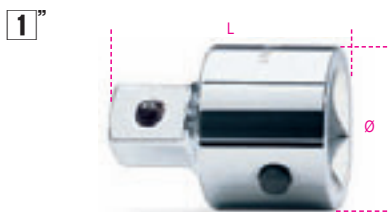

UNI/ISO 3316 DIN 3123

L mm	Ø mm	□	■	
65	47	1"	3/4"	2 009290801



Always apply torque loads evenly and progressively to avoid breakage and any possible injury.

929/21 - 929/22

1" drive extension bars



UNI/ISO 3316 DIN 3123

	L mm	Ø mm	
929/21	200	47	1 009290815
929/22	400	47	1 009290825

929/42

1" drive slide T-handle



UNI/ISO 3315 DIN 3122

L mm	
535	1 009290850

929/55

1" reversible ratchet 72 teeth



UNI/ISO 3315 DIN 3122

L mm	Ø mm	A mm	
770	62	63	1 009290860

929/C8

8 hexagon sockets and 5 accessories



929/C8 1 009290925

929	46 - 50 - 55 - 60 - 65 70 - 75 - 80 mm □ 1" - ■ 3/4"
929/15	
929/21	200 mm
929/22	400 mm
929/42	
929/55	

560x290x12 mm - 29 kg

900/R55



900/R55 900/55 1 009000871

900M/R55



900M/R55 900M/55 1 009000888

910/R55



910/R55 606/6-606/10-612
666/6-666/10-910/55
599DGT/6 1 009100879

910M/R55



910M/R55 910M/55-910M/56 1 009100888

910/R55Q



910/R55Q 910/55Q 1 009100877

910/R55X



910/R55X 666N/2X 1 009100897

920/R50



920/R50
614/50-667/20-667/30
920/50

1 009200866

920/R55



920/R55
606/20-606/30-666/20-666/30
920/55-920/56A- 599DGT/20-599DGT/30

1 009200879

920M/R55



920M/R55
920M/55-920M/56

1 009200888

920/R55Q



920/R55Q
920/55Q

1 009200877

920/R55X



920/R55X
606/10X-612X
666/10X-920/55X-599DGT/10X

1 009200878

920/R55LC



920/R55LC
920/55LC "Locking System"

1 009200887

928/R55



928/R55
928/55

1 009280859

928/R55X



928/R55X
614X

1 009280858

929/R55



929/R55
929/55

1 009290859

930

double ended bi-hex tubular socket wrenches,
heavy series



UNI 6745

mm	L	Ø	Ø1	
6x7	100	9,5	11,0	3 009300006
8x9	108	12,5	14,0	3 009300010
10x11	116	15,0	16,5	3 009300014
12x13	124	17,5	19,0	3 009300018
14x15	132	20,0	21,5	3 009300023
16x17	140	23,0	24,0	3 009300027
18x19	148	25,0	26,5	3 009300032
20x22	156	28,0	30,0	2 009300036
21x23	163	29,0	31,5	2 009300040
24x26	173	33,0	35,5	2 009300044
25x28	182	34,5	38,0	2 009300048
27x29	191	37,0	39,5	2 009300052
30x32	200	40,5	43,0	2 009300056



930/S8

6x7-8x9-10x11
12x13-14x15-16x17
18x19-20x22 mm

940/1 - /2

1 009300081

930/S13

6x7-8x9-10x11-12x13
14x15-16x17-18x19
20x22-21x23-24x26
25x28-27x29-30x32 mm
940/1 - /2 - /3

1 009300083



930/C13

6x7-8x9-10x11-12x13
14x15-16x17-18x19
20x22-21x23-24x26
25x28-27x29-30x32 mm
940/1 - /2 - /3

1 009300098

932

double ended hexagon / bi-hex offset
socket wrenches, bright chrome-plated

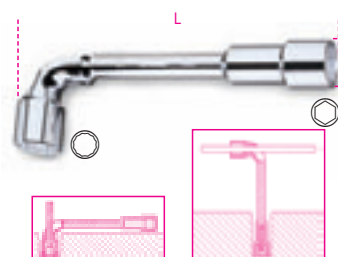

NF E 74.303

mm	Ø	L	
6x6	11,5	110	5 009320006
7x7	12,5	116	5 009320007
8x8	13,0	120	5 009320008
9x9	14,0	125	5 009320009
10x10	16,5	133	5 009320010
11x11	17,5	143	5 009320011
12x12	19,0	148	5 009320012
13x13	19,5	154	5 009320013
14x14	21,5	167	5 009320014
15x15	22,5	182	5 009320015
16x16	24,5	193	5 009320016
17x17	26,0	198	5 009320017
18x18	26,5	215	5 009320018
19x19	29,0	220	5 009320019
20x20	30,5	222	3 009320020
21x21	30,5	236	3 009320021
22x22	32,5	250	2 009320022
23x23	33,5	256	2 009320023
24x24	35,0	272	2 009320024
25x25	36,5	282	2 009320025
26x26	37,5	296	2 009320026
27x27	39,0	296	2 009320027
28x28	39,0	314	2 009320028
30x30	42,5	348	2 009320030
32x32	45,5	364	2 009320032



932/S11

6-7-8-10-11-12
13-14-17-19-22 mm

932/S17

6-7-8-9-10-11-12
13-14-15-16-17
18-19-20-21-22 mm

932/S25

6-7-8-9-10-11-12-13
14-15-16-17-18-19
20-21-22-23-24-25
26-27-28-30-32 mm

1 009320080

1 009320081

1 009320082

933

double ended offset hexagon socket wrenches, bright chrome-plated

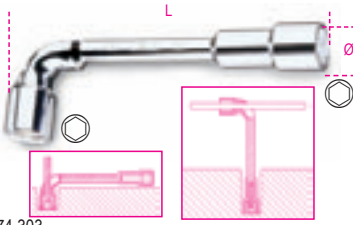

NF E 74.303

mm	Ø mm	L mm		
6x6	11,5	110	5	009330006
7x7	12,5	116	5	009330007
8x8	13,0	120	5	009330008
9x9	14,0	125	5	009330009
10x10	16,5	133	5	009330010
11x11	17,5	143	5	009330011
12x12	19,0	148	5	009330012
13x13	19,5	154	5	009330013
14x14	21,5	167	5	009330014
15x15	22,5	182	5	009330015
16x16	24,5	193	5	009330016
17x17	26,0	198	5	009330017
18x18	26,5	215	5	009330018
19x19	29,0	220	5	009330019
20x20	30,5	222	3	009330020
21x21	30,5	236	3	009330021
22x22	32,5	250	2	009330022
23x23	33,5	256	2	009330023
24x24	35,0	272	2	009330024
25x25	36,5	282	2	009330025
26x26	37,5	296	2	009330026
27x27	39,0	296	2	009330027
28x28	39,0	314	2	009330028
30x30	42,5	348	2	009330030
32x32	45,5	364	2	009330032

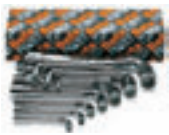

933/S11 6-7-8-10-11-12 13-14-17-19-22 mm	1	009330080
933/S17 6-7-8-9-10-11-12 13-14-15-16-17 18-19-20-21-22 mm	1	009330081
933/S25 6-7-8-9-10-11-12-13 14-15-16-17-18-19 20-21-22-23-24-25 26-27-28-30-32 mm	1	009330082

935

double ended hexagon tubular socket wrenches, light series



UNI 6746 DIN 896

mm	L mm		
6x7	100	5	009350105
8x9	110	5	009350111
10x11	120	5	009350115
12x13	130	5	009350117
14x15	140	5	009350126
16x17	150	5	009350128
18x19	160	5	009350131
20x22	170	3	009350138
21x23	180	3	009350141
24x26	190	3	009350144
25x28	200	2	009350150
27x29	210	2	009350153
30x32	220	2	009350156

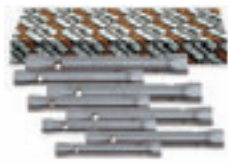

935/S8 6x7-8x9-10x11 12x13-14x15-16x17 18x19-20x22 mm	1	009350181
940/1 - /2 935/S13 6x7-8x9-10x11 12x13-14x15-16x17 18x19-20x22-21x23 24x26-25x28-27x29 30x32 mm	1	009350183
940/1 - /2 - /3		

937

double ended hexagon / bi-hex socket wrenches, chrome-plated

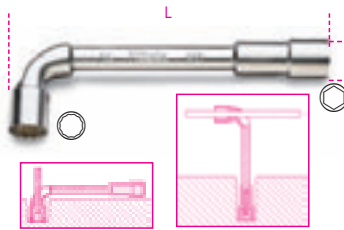

mm	Ø mm	L mm		
6x6	11,5	110	5	009370006
7x7	12,5	116	5	009370007
8x8	13,0	120	5	009370008
9x9	14,0	125	5	009370009
10x10	16,5	133	5	009370010
11x11	17,5	143	5	009370011
12x12	19,0	148	5	009370012
13x13	19,5	154	5	009370013
14x14	21,5	167	5	009370014
15x15	22,5	182	5	009370015
16x16	24,5	193	5	009370016
17x17	26,0	198	5	009370017
18x18	26,5	215	5	009370018
19x19	29,0	220	5	009370019
20x20	30,5	222	3	009370020
21x21	30,5	236	3	009370021
22x22	32,5	250	2	009370022
23x23	33,5	256	2	009370023
24x24	35,0	272	2	009370024
25x25	36,5	282	2	009370025
26x26	37,5	296	2	009370026
27x27	39,0	296	2	009370027
28x28	39,0	314	2	009370028
30x30	42,5	348	2	009370030
32x32	45,5	364	2	009370032



937/S11 6-7-8-10-11-12 13-14-17-19-22 mm	1	009370080
937/S17 6-7-8-9-10-11-12 13-14-15-16-17 18-19-20-21-22 mm	1	009370081

940

tommy bars for tubular wrenches items 930 and 935



	mm	L mm		
940/1	6+13	100	5	009400001
940/2	14+22	170	5	009400002
940/3	21+32	290	5	009400003

941

hexagon / bi-hex socket wrenches, with high torque handles

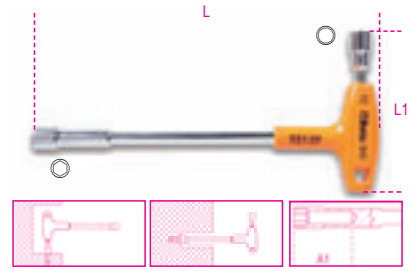

mm	L mm	L1 mm	A1 mm		
7x7	200	91	35	2	009410107
8x8	220	107	50	2	009410108
9x9	220	109	50	2	009410109
10x10	236	111	50	2	009410110
11x11	236	114	50	2	009410111
12x12	255	122	50	2	009410112
13x13	255	124	55	2	009410113



941/S7 7-8-9-10-11-12-13 mm	1	009410170
---------------------------------------	---	-----------

942BX

hi-torque hexagon nut spinners short series



UNI 6750

mm	L mm	L1 mm	A1 mm		
4	190	70	13,0	5	009420003
5	190	70	14,0	5	009420004
5,5	190	70	12,5	5	009420005
6	190	70	14,5	5	009420006
7	190	70	15,5	5	009420007
8	202	70	18,5	5	009420008
9	202	70	19,5	5	009420009
10	202	70	20,5	3	009420010
11	202	70	21,5	3	009420011
12	202	70	22,5	3	009420012
13	202	70	23,5	3	009420013
14	202	70	24,5	3	009420014



942BX/S12
4-5-5,5-6-7-8-9
10-11-12-13-14 mm

1 009420030

943BX

hi-torque hexagon nut spinners
long series



ISO 2236 UNI 6750

Ø mm	L mm	L1 mm	A1 mm	
4	270	150	13,0	5 009430003
5	270	150	14,0	5 009430004
5,5	270	150	12,5	5 009430005
6	270	150	14,5	5 009430006
7	270	150	15,5	5 009430007
8	282	150	18,5	5 009430008
9	282	150	19,5	5 009430009
10	282	150	20,5	3 009430010
11	282	150	21,5	3 009430011
12	282	150	22,5	3 009430012
13	282	150	23,5	3 009430013
14	282	150	24,5	3 009430014



943BX/S12
4-5-5,5-6-7-8-9
10-11-12-13-14 mm

1 009430030



943BX/D6
5-6-7-8-10-13 mm

1 009430026



943FL

flexible hexagon nut spinners
with handles



Ø mm	L mm	L1 mm	Ø mm	
5	265	150	8	2 009430304
5,5	265	150	8	2 009430305
6	265	150	9	2 009430306
7	265	150	11	2 009430307
8	265	150	12	2 009430308
10	290	175	14	2 009430310



943FL/S6
5-5,5-6-7-8-10 mm

1 009430320

944BX

deep, hi-torque hexagon nut spinners
long series



ISO 2236 UNI 6750

Ø mm	L mm	L1 mm	A1 mm	
4	245	125	20	3 009440003
5	245	125	25	3 009440004
5,5	245	125	30	3 009440005
6	245	125	35	3 009440006
7	245	125	35	3 009440007
8	257	125	50	3 009440008
9	257	125	50	3 009440009
10	257	125	50	3 009440010
11	257	125	50	3 009440011
12	257	125	50	3 009440012
13	257	125	55	3 009440013
14	257	125	55	3 009440014



944BX/S12
4-5-5,5-6-7-8-9
10-11-12-13-14 mm

1 009440062



944BX/D6
5-6-7-8-10-13 mm

1 009440056

949

deep T-handle socket wrenches

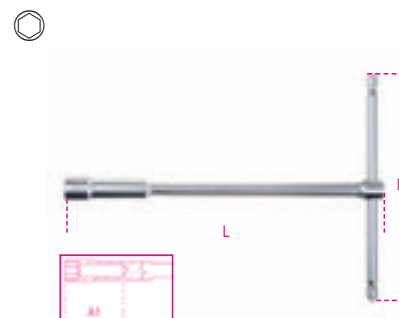

Ø mm	L mm	L1 mm	A1 mm	
8	220	160	50	2 009490008
10	230	160	50	2 009490010
12	240	175	50	2 009490012
13	244	175	55	2 009490013
14	250	190	55	2 009490014
17	264	200	60	2 009490017



949/S6
8-10-12-13-14-17mm

1 009490076



950

T-handle hexagon socket wrenches

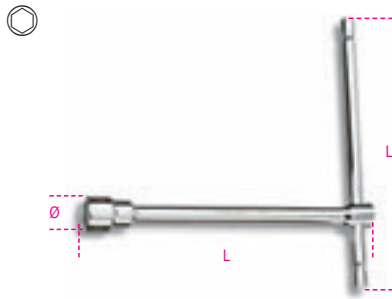

UNI 6742 DIN 3112

mm	L mm	Ø mm	L1 mm		
6	210	10,1	145	3	009500006
7	212	11,2	145	3	009500007
8	220	12,4	160	3	009500008
9	223	13,5	160	3	009500009
10	230	14,9	160	3	009500010
11	233	16,1	160	3	009500011
12	240	17,5	175	3	009500012
13	244	19,7	175	3	009500013
14	250	20,1	190	3	009500014
15	254	21,5	190	3	009500015
16	260	22,7	200	3	009500016
17	264	24,1	200	3	009500017
19	274	26,6	230	3	009500019
22	290	29,9	290	2	009500022
24	300	32,2	320	2	009500024
27	315	36,2	370	2	009500027



950/S9	7-8-10-11-12	1	009500079
	13-14-17-19 mm		
950/S14	6-7-8-9-10-11-12-13	1	009500082
	14-15-16-17-19-22 mm		

951

T-handle wrenches with three hexagon male ends

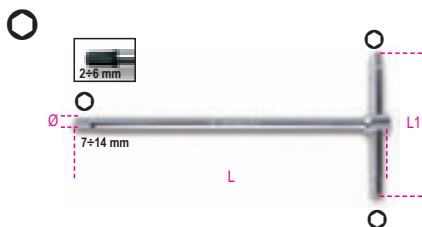

mm	L mm	L1 mm	Ø mm		
2	125	63	4,0	5	009510521
2,5	150	63	4,0	5	009510525
3	150	63	4,0	5	009510530
3,5	175	76	5,5	5	009510535
4	175	76	5,5	5	009510540
4,5	195	87	6,5	5	009510545
5	195	87	6,5	5	009510550
6	215	99	8,0	5	009510560
7	230	109	9,0	5	009510570
8	250	122	10,0	5	009510580
9	265	132	11,0	5	009510590
10	280	142	12,0	5	009510610
12	305	160	15,0	3	009510620
14	330	178	17,0	3	009510640

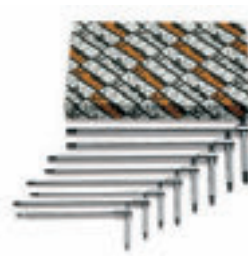

951/S6	2,5-3-4-5-6-8 mm	1	009510687
951/S8	2-2,5-3-3,5-4-4,5-5-6 mm	1	009510693
951/S14	2-2,5-3-3,5-4-4,5-5-6-7-8-9-10-12-14 mm	1	009510695



951/SP6	3-4-5-6-8-10 mm	1	009510696
951/SPV		1	009510697

951AS

T-handle wrenches with three hexagon male ends

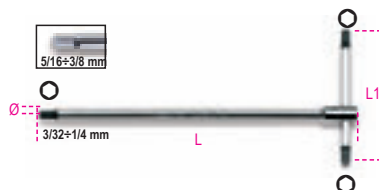

"	L mm	L1 mm	Ø mm		
3/32	125	63	4,0	2	009510750
7/64	150	63	4,0	2	009510751
1/8	150	63	4,0	2	009510752
9/64	175	76	5,5	2	009510753
5/32	175	76	5,5	2	009510754
3/16	195	86	6,5	2	009510755
7/32	215	99	8,0	2	009510757
1/4	230	109	9,0	2	009510758
5/16	250	122	10,0	2	009510759
3/8	280	142	12,0	2	009510760

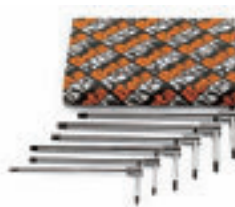

951AS/S6X	1/8-3/16-7/32-1/4-5/16-3/8	1	009510771
------------------	----------------------------	---	-----------

951TX

T-handle wrenches with three male ends for Torx® head screws



	L mm	L1 mm	Ø mm		
T6	125	63	4	3	009510806
T7	125	63	4	3	009510807
T8	125	63	4	3	009510808
T9	125	63	4	3	009510809
T10	150	63	4	3	009510810
T15	150	63	4	3	009510815
T20	175	76	5	3	009510820
T25	175	76	5	3	009510825
T27	195	87	6	3	009510827
T30	195	87	6	3	009510830
T40	215	99	7	3	009510840
T45	230	109	8	3	009510845
T50	250	122	9	3	009510850

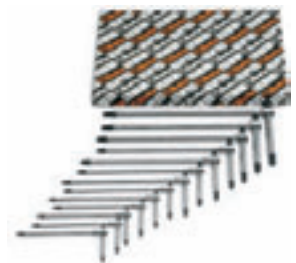

951TX/S6	T8-T10-T15-T20-T25-T30	1	009510866
951TX/S13	T6-T7-T8-T9-T10-T15-T20-T25-T27-T30-T40-T45-T50	1	009510863

952

T-handle wrenches with swivelling hexagon sockets

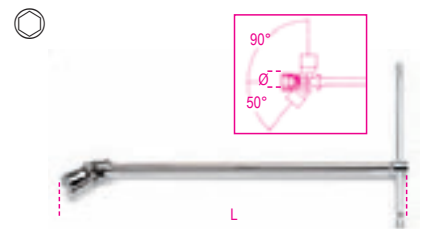

UNI 6743

mm	Ø mm	L mm		
6	9,5	395	5	009520006
7	10,7	395	5	009520007
8	12,1	395	5	009520008
9	13,2	395	5	009520009
10	14,6	400	5	009520010
11	15,8	400	5	009520011
12	17,0	400	5	009520012
13	18,7	432	5	009520013
14	19,7	432	5	009520014
15	20,9	450	3	009520015
16	22,0	450	3	009520016
17	23,4	450	3	009520017
18	24,7	450	3	009520018
19	26,0	500	3	009520019
20	27,4	500	3	009520020
21	28,5	500	3	009520021
22	29,7	500	3	009520022
24	32,4	500	3	009520024



952/S7 8-10-11-13-14-17-19 mm	1	009520074
952/S10 7-8-10-11-12-13-14-15-17-19 mm	1	009520080
952/S18 6-7-8-9-10-11-12-13-14-15-16-17-18-19-20-21-22-24 mm	1	009520083

952AS

T-handle wrenches with swivelling hexagon sockets

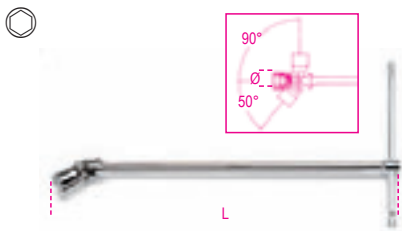

⌀	Ø	L		
"	mm	mm		
1/4	9,5	395	2	009520256
5/16	12,1	395	2	009520258
3/8	14,6	400	2	009520260
7/16	15,8	400	2	009520261
1/2	18,7	432	2	009520263
9/16	19,7	432	2	009520264
5/8	22,0	450	2	009520266
11/16	23,4	450	2	009520267
3/4	26,0	500	2	009520269

952L

T-handle wrenches with swivelling hexagon sockets, long series

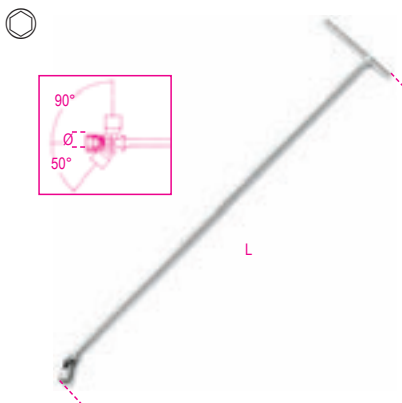

⌀	Ø	L		
mm	mm	mm		
10	14,6	930	1	009520410
12	17,0	1063	1	009520412
13	18,7	1100	1	009520413
14	19,7	1100	1	009520414
15	20,9	1100	1	009520415
16	22,0	1100	1	009520416
17	23,4	1100	1	009520417
18	24,7	1100	1	009520418
19	26,0	1100	1	009520419

952FTX

T-handle wrenches with swivelling socket, for Torx® head screws

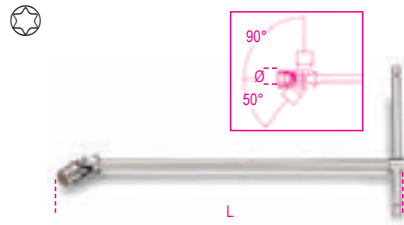

⌀	Ø	L		
mm	mm	mm		
E6	8	392	2	009520106
E7	9	392	2	009520107
E8	10	395	2	009520108
E10	13	400	2	009520110
E12	15	440	2	009520112
E14	17	490	2	009520114
E16	19	490	2	009520116
E18	21	490	2	009520118
E20	23	490	2	009520120



952FTX/S9 E6-E7-E8-E10-E12 E14-E16-E18-E20	1	009520141
---	---	-----------

953

T-handle wrenches with swivelling hexagon male ends

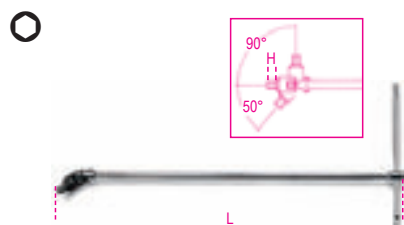

UNI 6754

mm	H	L		
mm	mm	mm		
3	5	395	5	009530130
3,5	6	395	3	009530135
4	6	395	5	009530140
4,5	7	395	3	009530145
5	7	395	5	009530150
6	9	400	5	009530160
7	10	425	3	009530170
8	11	425	5	009530180
10	13	440	5	009530200



953/S5 3-4-5-6-8 mm	1	009530305
953/S9 3-3,5-4-4,5 5-6-7-8-10 mm	1	009530301

953TX

T-handle wrenches with swivelling end for Torx® head screws

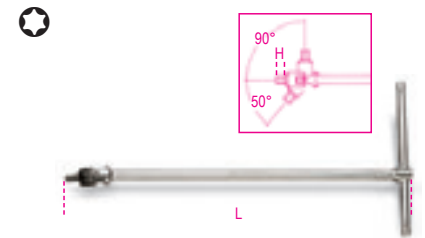

⌀	H	L		
mm	mm	mm		
T20	11	396	2	009530020
T25	11	396	2	009530025
T27	11	396	2	009530027
T30	13	400	2	009530030
T40	13	400	2	009530040
T45	13	426	2	009530045
T50	14	442	2	009530050
T55	14	442	2	009530055



953TX/S8 T20-T25-T27-T30 T40-T45-T50-T55	1	009530060
---	---	-----------

990

straight thin knurled point spring tweezers made from stainless steel bright finish



991

bent thin knurled point spring tweezers made from stainless steel, bright finish



992

straight thin knurled point pin spring tweezers made from stainless steel bright finish



993

bent thin knurled point pin spring tweezers made from stainless steel bright finish



L
mm 145 5 009930001

993PL

bent thin knurled point pin spring tweezers made from stainless steel PVC-coated



L
mm 150 3 009930010

993G

pin spring tweezers, curved round ends, knurled made from stainless steel bright finish



L
mm 160 3 009930030

994

straight large knurled point spring tweezers made from stainless steel bright finish



L
mm 150 5 009940001

994PL

straight large knurled point spring tweezers made from stainless steel PVC-coated



L
mm 150 3 009940010

994TF

spring tweezers, acid and magnetic resistant, large round noses, strong and knurled ends made from stainless steel semi-bright finish



L
mm 150 3 009940020

996

straight end spring tweezers with wide tips made from stainless steel bright finish



L
mm 150 5 009960001

998

cross knurled end spring tweezers made from stainless steel bright finish



L
mm 155 5 009980001

999

flat round end spring tweezers, acid and magnetic resistant made from stainless steel semi-bright finish



L
mm 115 3 009990011

999A

extra slim short end spring tweezers, acid and magnetic resistant made from stainless steel semi-bright finish



L
mm 120 3 009990015

999B

strong straight end spring tweezers, acid and magnetic resistant made from stainless steel semi-bright finish



L
mm 120 3 009990017

999C

extra slim straight end spring tweezers, acid and magnetic resistant made from stainless steel semi-bright finish



L
mm 110 3 009990019

999D

extra slim angled end spring tweezers, acid and magnetic resistant made from stainless steel semi-bright finish



L
mm 115 3 009990021

999E

extra slim curved end spring tweezers, acid and magnetic resistant made from stainless steel semi-bright finish



L
mm 120 3 009990023

999G

extra slim straight end spring tweezers, acid and magnetic resistant with stop mechanism made from stainless steel semi-bright finish



L
mm 140 3 009990027

999/B6

set of 6 spring tweezers, acid and magnetic resistant



999/B6
999-999A-999B
999C-999D-999E

1 009990050

1002

self-locking round end knurled tool made of stainless steel



L
mm
160

2 010020001

1008

long flat knurled nose pliers, slip-proof double layer PVC coated handles



ISO 5745

L mm 160
L1 mm 51,5

5 010080006

1008BM

long flat knurled nose pliers bi-material handles



ISO 5745

L mm 160
L1 mm 51,5

3 010080036

1009

extra-long knurled nose pliers, slip-proof double layer PVC coated handles



L mm 160
L1 mm 56,5

2 010090006

1009L/A

extra long needle knurled nose pliers, for special operations, slip-proof double layer PVC coated handles



L mm 283
L1 mm 80

2 010090008

1009L/B

curved extra long knurled nose pliers, 45°, for special operations, slip-proof double layer PVC coated handles



L mm 273
L1 mm 73

2 010090009

1009L/C

bent extra long knurled nose pliers, 90°, for special operations, slip-proof double layer PVC coated handles



L mm 253
L1 mm 45

2 010090010

1009L/D

extra-long, knurled double swivel nose pliers, slip-proof double layer PVC coated handles



L mm 342
L1 mm 71

1 010090058

1009L/DP

curved extra-long knurled double swivel nose pliers, 45°, slip-proof double layer PVC-coated handles



L mm 336
L1 mm 66

1 010090059

1010

long round knurled nose pliers, slip-proof double layer PVC coated handles



ISO 5745

L mm 160
L1 mm 51,5

2 010100006

1010BM

long round knurled nose pliers bi-material handles



ISO 5745

L mm 160
L1 mm 51,5

2 010100036

1031/S4

set of 4 circlip pliers



1031/S4

1032 180 ⌀ 19 ÷ 60 mm
1034 170 ⌀ 19 ÷ 60 mm
1036 175 ⌀ 19 ÷ 60 mm
1038 175 ⌀ 19 ÷ 60 mm

1 010310000

1032

internal circlip pliers, straight pattern
PVC-coated handles



UNI 7914 DIN 5256

L mm	∅ mm	
140x0,9	8÷12	5 010320013
140x1,3	12÷25	5 010320014
180	19÷60	5 010320017
225	40÷100	3 010320021
300	85÷200	2 010320028

1033

internal circlip pliers, bent pattern,
45° PVC-coated handles



UNI 7914 DIN 5256

L mm	∅ mm	
140x0,9	8÷12	5 010330013
140x1,3	12÷25	5 010330014
180	19÷60	5 010330017
225	40÷100	3 010330021

1034

internal circlip pliers, bent pattern,
90° PVC-coated handles



UNI 7914 DIN 5256

L mm	∅ mm	
130x0,9	8÷12	5 010340013
130x1,3	12÷25	5 010340014
170	19÷60	5 010340017
210	40÷100	3 010340021
290	85÷200	2 010340028

1034L

90° curved long nose pliers
for elastic safety rings for holes,
PVC-coated handles



L mm	∅ mm	
190	40÷100	2 010340320

1036

external circlip pliers, straight pattern
PVC-coated handles



UNI 7915 DIN 5254

L mm	∅ mm	
140x0,9	3÷10	5 010360013
140x1,3	10÷25	5 010360014
175	19÷60	5 010360017
225	40÷100	3 010360021
300	85÷200	2 010360028

1037

external circlip pliers, bent pattern,
45° PVC-coated handles



UNI 7915 DIN 5254

L mm	∅ mm	
140x0,9	3÷10	5 010370013
140x1,3	10÷25	5 010370014
175	19÷60	5 010370017
225	40÷100	3 010370021

1038

external circlip pliers, bent pattern,
90° PVC-coated handles



UNI 7915 DIN 5254

L mm	∅ mm	
135x0,9	3÷10	5 010380013
135x1,3	10÷25	5 010380014
175	19÷60	5 010380017
220	40÷100	3 010380021
300	85÷200	2 010380028

1039

straight point pliers for internal
and external circlips PVC-coated handles



L mm	∅ mm	∅ mm	
150	10÷15	6÷25	2 010390015

1558/C4

internal and external snap ring tool,
screw-operated

square drive allows a high force to be applied
in both operating conditions

Supplied tips:
∅ 2.5-3-3.5 mm



∅ mm	∅ mm	
1558/C4 5,5 ÷ 77	5,5 ÷ 77	1 015580100

330x220x50 mm - 900 g

1044

slip joint pliers overlapping joint
PVC-coated handles

· 9-position model



ISO 8976

L mm	A max mm	L1 mm	
250	48	39	5 010440250

1044F

slip joint pliers
overlapping joint
PVC-coated handles

· 9-position model



ISO 8976

L mm	A max mm	L1 mm	
250	48	39	5 010440015

1046

slip joint pliers overlapping rack-type joint
PVC-coated handles

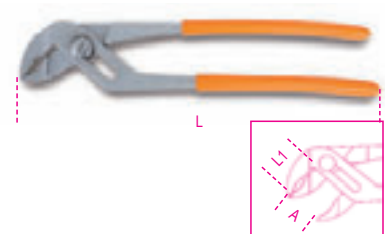

ISO 8976

L mm	A max mm	L1 mm	
240	28	33	5 010460240
400	107	55	1 010460400

1047

slip joint pliers, push button adjustment

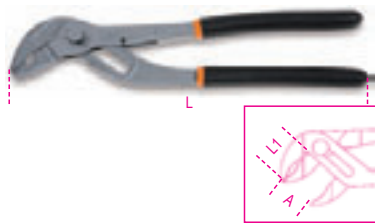

L mm	A max mm	L1 mm		
180	30	29	2	010470180
240	36	35	2	010470240
300	50	48	1	010470300

1047BM

slip joint pliers, push button adjustment, bimaterial handles

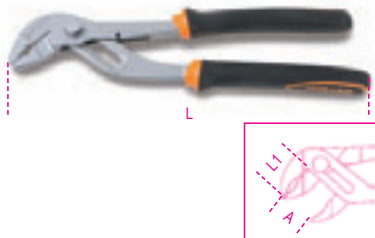

L mm	A max mm	L1 mm		
240	36	35	2	010470340

1048

Slip joint pliers, boxed joints, slip-proof double layer PVC coated handles

· 9-position model

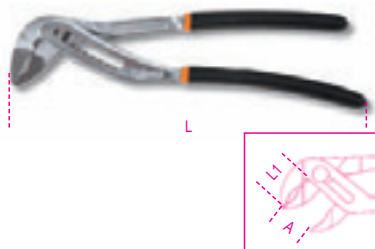

ISO 8976

L mm	A max mm	L1 mm		
175	30	29	3	010480010
250	48	39	5	010480015
300	56	47	2	010480020

1048BM

slip joint pliers, boxed joint, bimaterial handles

· new 9-position model

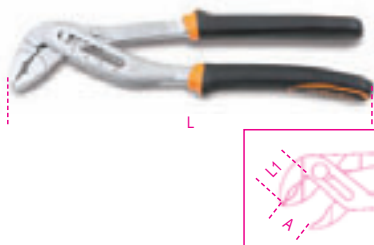

L mm	A max mm	L1 mm		
250	48	39	3	010480215

1048V

slip joint pliers boxed joints, orange lacquered

· new 9-position model

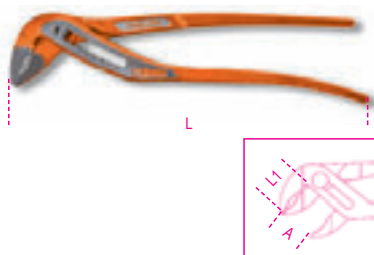

ISO 8976

L mm	A max mm	L1 mm		
175	30	29	3	010480110
250	48	39	5	010480115
300	56	47	2	010480120

1050

double adjustment self-locking pliers

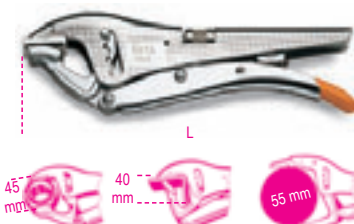

L mm		
220	2	010500022

1051

double adjustment self-locking pliers long jaws



L mm		
255	2	010510025

1051GM

double adjustment self-locking pliers, floating jaw

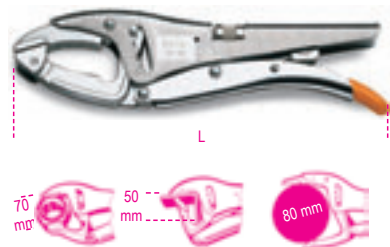

L mm		
255	2	010510250

1051L

large-capacity double adjustment self-locking pliers

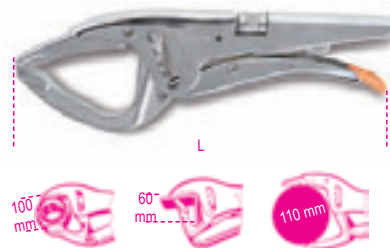

L mm		
270	2	010510100

1051XL

large-capacity double adjustment self-locking pliers, extra-long jaws

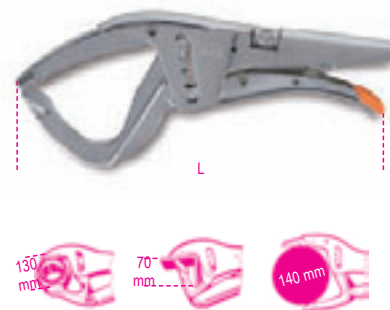

L mm		
270	2	010510140

1052

adjustable self-locking pliers, concave jaws

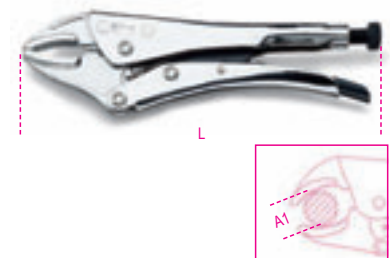

L mm	A1 max mm		
140	22	3	010520014
190	36	3	010520019
240	42	3	010520024
300	55	2	010520030

Beta

1053

adjustable self-locking pliers,
floating jaw



L

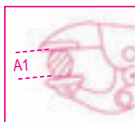

L mm	A1 max mm		
240	35	2	010530024

1054

adjustable self-locking pliers,
straight jaws



L

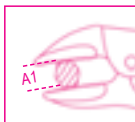

L mm	A1 max mm		
235	40	2	010540022

1055

adjustable self-locking pliers,
curved jaws



L

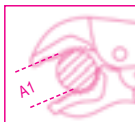

L mm	A1 max mm		
250	60	2	010550024

1056

adjustable self-locking pliers
for refrigerator engineers



L



L mm	A1 max mm		
190	3	2	010560019

1057A

automatic self-locking pliers with adjustable
force



L



L mm			
240		2	010570124

1058

adjustable self-locking pliers,
long jaws



L

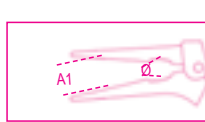

L mm	A1 max mm	Ø max mm		
180	35	22	2	010580018
240	50	35	2	010580024
310	65	40	2	010580031

1060

adjustable self-locking pliers,
fork-type jaws



L



L mm	A1 max mm		
200	50	2	010600020
280	80	2	010600028

1061

adjustable self-locking pliers,
fork-type jaws



L



L mm	A1 max mm		
290	80	2	010610028

1062

adjustable self-locking pliers
with C-shaped jaws



L



L mm	A1 max mm		
170	50	2	010620017
290	120	2	010620029
460	250	1	010620046

1062AL

adjustable self-locking pliers,
aluminium C-shaped jaws



L



L mm	A1 max mm		
290	104	2	010620329

1062GM

adjustable self-locking pliers
with floating C-shaped jaws



L



L mm	A1 max mm		
170	45	2	010620217
290	88	2	010620229
460	260	1	010620246

1063

adjustable self-locking pliers for tinsmiths



L	A1 max		
mm	mm		
200	30	2	010630020

1064

adjustable self-locking pliers with chain



L	Ø		
mm	mm		
240	150	2	010640024

1065F

hand punch steel punch and matrix

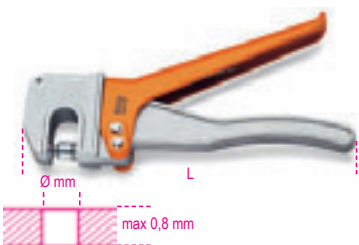

Ø	L		
mm	mm		
5	228	1	010650010
6	228	1	010650015

1065P

hand crimper steel matrix



L			
mm			
228		1	010650020

1077

straight wide blade tinsmith's pliers, PVC-coated handles



L	A	L1		
mm	mm	mm		
280	60	53	1	010770026

1078

curved wide blade tinsmith's pliers, 45° PVC-coated handles



L	A	L1		
mm	mm	mm		
280	60	77	1	010780026

1080D

diagonal flush cutting nippers, slip-proof double layer PVC coated handles

For cutting plastic



α	L	L1		
°	mm	mm		
15°	160	22	3	010800015
45°	160	22	3	010800045

1082

diagonal cutting nippers, slip-proof double layer PVC coated handles



UNI/ISO 5749

L	L1	≠		
mm	mm	mm		
140	20	1,6	5	010820004
160	22	1,6	5	010820006

1082BM

diagonal cutting nippers, bi-material handles



UNI/ISO 5749

L	L1	≠		
mm	mm	mm		
140	20	1,6	3	010820034
160	22	1,6	3	010820036

1084

heavy duty diagonal cutting nippers, slip-proof double layer PVC coated handles



UNI/ISO 5749

L	L1	≠		
mm	mm	mm		
140	20	1,4	5	010840004
160	22	1,6	5	010840006
180	25	1,8	3	010840008
200	28	2,0	3	010840010

1084BM

heavy duty diagonal cutting nippers, bi-material handles



UNI/ISO 5749

L	L1	≠		
mm	mm	mm		
140	20	1,4	3	010840034
160	22	1,6	3	010840036
180	25	1,8	3	010840038
200	28	2,0	3	010840040

1088

heavy duty end cutting nippers, slip-proof double layer PVC coated handles

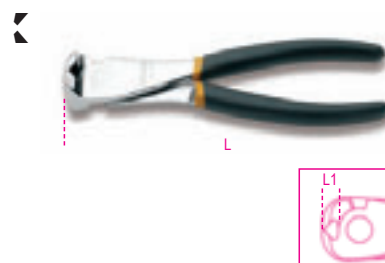

UNI/ISO 5748

L	L1	≠		
mm	mm	mm		
160	9	1,6	2	010880006
200	11	2,0	2	010880010

1088BM

heavy duty end cutting nippers, bi-material handles

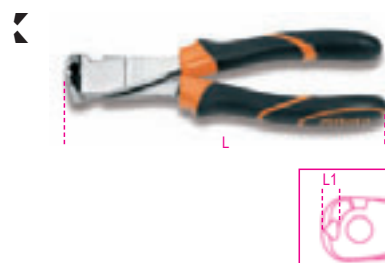

UNI/ISO 5748

L	L1	≠		
mm	mm	mm		
160	9	1,6	2	010880036
200	11	2,0	2	010880040

1092V

toggle lever assisted end cutting nippers

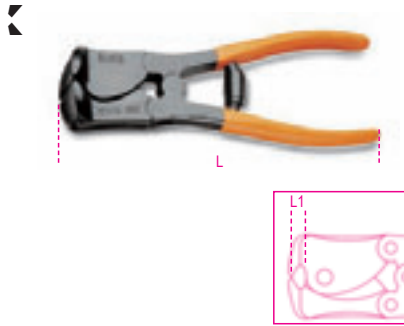

UNI/ISO 5748

L mm	L1 mm	$\frac{R}{\text{mm}}$	
180	8	2,0	2 010920280
200	9	2,5	2 010920310

1094V

toggle lever assisted diagonal cutting nippers



UNI/ISO 5749

L mm	L1 mm	$\frac{R}{\text{mm}}$	
200	23	2,5	2 010940200

1095N

toggle lever assisted diagonal cutting nippers



L mm	L1 mm	$\frac{R}{\text{mm}}$	
195	26	1,6	2 010950010

1096

carpenter's pincers



ISO 9243

L mm	L1 mm	
160	21	5 010960016
200	23	5 010960020
250	30	5 010960025

1098

construction worker's pincers



ISO 9242 DIN 5242

L mm	L1 mm	
190	12	5 010980190
220	13	5 010980220
250	15	5 010980250
280	18	5 010980280

1098PL

construction worker's pincers, PVC coated handles



ISO 9242 DIN 5242

L mm	L1 mm	
220	13	5 010980320
250	15	5 010980350
280	18	5 010980380

1101

bolt cutter phosphatized blades and rubber grip handles



L mm	L mm	
300	12	2 011010030
350	14	2 011010035
450	18	1 011010045
600	24	1 011010060
750	30	1 011010075
900	36	1 011010090

L mm	R = 80 Kgf/mm ² Ø mm	R = 140 Kgf/mm ² Ø mm	g
300	5	4	745
350	6	5	1043
450	7	6	1537
600	9	7	2540
750	11	8	3870
900	12	9	6170

1101R

spare blades for item 1101



mm	1101	
300	300	1 011010130
350	350	1 011010135
450	450	1 011010145
600	600	1 011010160
750	750	1 011010175
900	900	1 011010190

1102

bolt cutters, small series

Cutting capacity
R= $\frac{R}{\text{mm}}$ 80 Kgf/mm²



L mm	$\frac{R}{\text{mm}}$	
230	4	3 011020020

1104

heavy-duty cutters for flexible steel cables, handles with thermoplastic grips

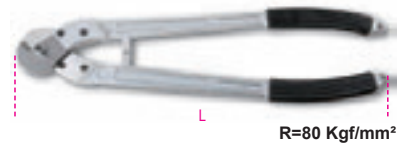

L mm	$\frac{R}{\text{mm}}$	
420	12	1 011040004
600	16	1 011040006

1104R

spare blades for item 1104



mm	
420	1 011040014
600	1 011040016

 **Beta**

 **Beta**

1105

punches made from burnished steel

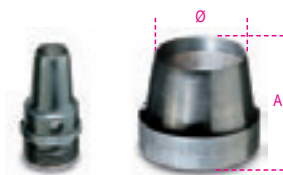

Ø mm	A mm		
2	27	1	011050002
3	27	1	011050003
4	27	1	011050004
5	27	1	011050005
6	27	1	011050006
7	27	1	011050007
8	27	1	011050008
9	27	1	011050009
10	27	1	011050010
12	27	1	011050012
14	27	1	011050014
16	27	1	011050016
18	27	1	011050018
20	27	1	011050020
22	32	1	011050022
24	32	1	011050024
26	32	1	011050026
28	32	1	011050028
30	32	1	011050030
32	37	1	011050032
34	37	1	011050034
36	37	1	011050036
38	37	1	011050038
40	37	1	011050040
42	42	1	011050042
44	42	1	011050044
46	42	1	011050046
48	42	1	011050048
50	42	1	011050050

1105T30

shank for punches 1105,
3 to 30 mm



L mm	
155	1 011050201

1105T50

shank for punches 1105
2 to 50 mm



L mm	
155	1 011050202

1105AD-50

shank adaptor for item 1105T50



Ø mm	
57	1 011050210

1105/C15T

assortment of 15 punches,
3 to 30 mm



1105C/15T	
	1 011050251

1105	3 - 4 - 6 - 8 - 10 - 12 - 14 - 16 - 18 - 20 - 22 - 24 - 26 - 28 - 30 mm
1105T30	
230x190x50 mm	

1105/C29T

assortment of 29 punches,
2 to 50 mm



1105C/29T	
	1 011050252

1105	2 - 3 - 4 - 5 - 6 - 7 - 8 - 9 - 10 - 12 - 14 - 16 - 18 - 20 - 22 - 24 - 26 - 28 - 30 - 32 - 34 - 36 - 38 - 40 - 42 - 44 - 46 - 48 - 50 mm
1105T50	
1105AD-50	
325x280x55 mm	

1112

tin snips straight wide blades

Cutting capacity
R = $\frac{S}{A} \leq 60 \text{ Kg/mm}^2$

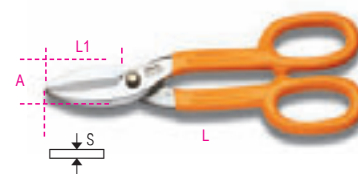

L	L1	S	A		
~	mm	mm	mm		
200	50	0,5	26	2	011120020
250	62	0,8	33	2	011120025
300	76	1,0	37	2	011120030
375	76	1,2	44	1	011120037

1114

tin snips straight narrow blades

R = 60 Kg/mm²

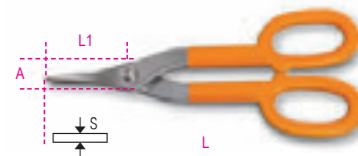

L	L1	S	A		
~	mm	mm	mm		
250	58	0,5	15	1	011140265
350	76	1	22	1	011140340

1118

safety strap cutting shears

Fe = normal steel
Inox = stainless steel



L	L1	Fe	Inox		
~	mm	S mm	S mm		
310	42	1	0,8	2	011180001

1120A

hand nibbler

Fe = normal steel



L	Fe		
mm	S mm		
280	1,2	1	011200101

1120ARL - ARG

spare parts for item 1120A



1120ARL	1	011200110
1120ARG	1	011200120

1122

compound leverage shears,
straight blades

Inox = stainless steel



L	L1	Inox	A		
mm	mm	S mm	mm		
250	40	1	24	2	011220020

1123

right cut compound leverage shears,
curved blades

Inox = stainless steel

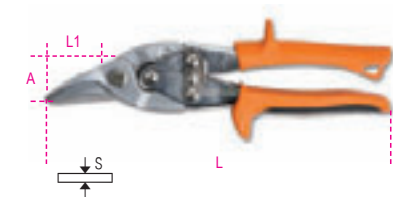

L	L1	Inox	A		
mm	mm	S mm	mm		
250	40	1	24	2	011230020

1124

left cut compound leverage shears,
curved blades

Inox = stainless steel



L	L1	Inox	A		
mm	mm	S mm	mm		
250	40	1	24	2	011240020

1125

compound leverage shears
for straight and right cuts

Inox = stainless steel

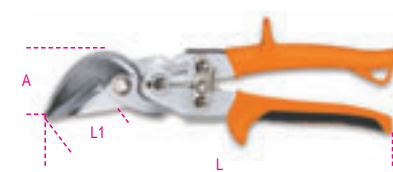

L	L1	Inox	A		
mm	mm	S mm	mm		
250	35	1	46	2	011250020

1126

compound leverage shears
for straight and left cuts

Inox = stainless steel

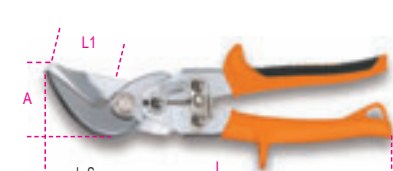

L	L1	Inox	A		
mm	mm	S mm	mm		
250	35	1	46	2	011260020

1122 - 1125MOL



1122 MOL	1122 - 1124	1	011220010
1123 MOL	1123	1	011230010
1125 MOL	1125 - 1126	1	011250040

1127

telephone engineer's scissors,
straight blades



L	L1		
mm	mm		
150	35	5	011270001

1128BAX

Double-acting electricians' scissors,
with milling profiles in DLC-coated stainless
steel

Double-acting cutting: a special cam on the fulcrum allows the blades to run lengthwise, which results in increased cutting power while closing the blades.

Profile and mill: designed to enlarge holes on plastic, from 13 mm to 25 mm.

DLC coating: DLC (diamond-like carbon) is an innovative carbon-based coating: the high hardness and low coefficient of friction arise from the simultaneous presence of carbon on the surface in the form of graphite, and diamond.

- High blade surface hardness (resistance to abrasion and wear)
- Low coefficient of friction (smoothness and anti-adherence)
- Anti-loose eccentric pin
- Large handles with pipe throttling grooves
- With articulated plastic case
- Patented

PATENTED



L	L1	mm ²		
mm	mm			
150	50	50	5	011280088

1128BCX

electrician's scissors,
straight stainless steel blades,
with microteeth, cable cutting groove and
crimping pliers for tube terminals

tube terminal crimping: 1÷4 mm²
in jointed plastic case



L	L1	mm ²		
mm	mm			
155	55	50	5	011280080

1128BMX

electrician's scissors,
straight stainless steel blades,
with microteeth

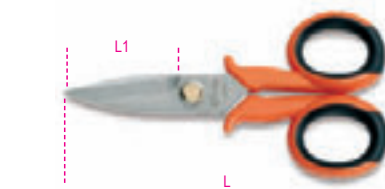

L	L1		
mm	mm		
145	54	5	011280050

1128BSX

electrician's scissors
with graduated milling profiles with case

PATENTED



L	L1		
mm	mm		
145	50	5	011280060

1128BM

electrician's scissors, straight blades



L	L1		
mm	mm		
145	50	5	011280060

1129BM

electrician's scissors, curved blades



L	L1		
mm	mm		
145	44	5	011290000

1130BMX

Multiuse scissors, straight stainless steel blades, with microteeth



L	L1		
mm	mm		
190	58	1	011300001

1131CK

Kevlar® and fibre optics scissors



L	L1		
mm	mm		
203	75	1	011310001

1132

cable cutters for insulated copper and aluminium cables, slip-proof double layer PVC coated handles



UNI 8791			
L	~	mm	mm ²
170	14	50	2 011320107
230	18	95	2 011320113

1132BM

cable cutters for insulated copper and aluminium cables, bi-material handles



UNI 8791			
L	~	mm	mm ²
170	14	50	2 011320137
230	18	95	2 011320143

1133

cable cutter for copper cables, flexible

up to 325 mm²



L	~	mm	mm ²		
600	32	300	1	011330001	

1133RL

spare blades for item 1133



1133RL					
				1	011330011

1134

ratchet cable cutters burnished finish, plastic handles



L	~	mm	mm ²		
260	35	400	1	011340032	

1134RL

spare blade for item 1134



1134RL					
				1	011340132

1134A

ratchet cable cutters burnished finish, plastic handles



L	~	mm	mm ²		
240	45	500	1	011340045	

1134A/RL

spare blade for item 1134A



1134A/RL					
				1	011340145

1136

cable cutter for steel cables

Cutting capacity
Ø 5 mm for cable R ≤ 160 Kg/mm²
Ø 4 mm for mild steel bolts



L	~	mm			
165			2	011360001	

1142BM

wire stripping pliers, bi-material handles



UNI 7923					
L	~	mm ²	mm		
160	0,5÷6	0-2,8	3	011420036	

1143

wire stripping pliers



L	~	mm ²	mm		
165	1÷6	1-3,2	1	011430001	

1143R

spare blades for item 1143

1143R					
				1	011430011



1144D

cable stripping tool



L mm	mm ²	mm	
170	4,5÷240	2,5-18	1 011440010

1144D/RG

spare hook for item 1144D



1144D/RG	1 011440012
----------	-------------

1144D/RL

spare blades for item 1144D

1144D/RL	1 011440011
----------	-------------

1144G

cable stripping tool

with adjustable blade for transverse and longitudinal cuts



L mm	mm ²	mm	
140	6÷75	2.8-12	1 011440004

1144G/RL

spare blade for item 1144G



1144G/RL	1 011440005
----------	-------------

1148A

wire stripping pliers, self-adjusting, with cutting device

cutting capacity
≠10 mm² (8 AWG) flexible wires
≠1,5 mm² (16 AWG) sturdy wires



L mm	mm ²	mm	
190	0,02÷10	0-4	1 011480100

1148A/R

spare blades for item 1148A



1148A/R	1 011480102
---------	-------------

1148B

wire stripping pliers, self-adjusting, with cutting device

cutting capacity
≠10 mm² (8 AWG) flexible wires
≠1,5 mm² (16 AWG) sturdy wires



L mm	mm ²	mm	
190	4÷16	2-5	1 011480200

1148B/R

spare blades for item 1148B



1148B/R	1 011480202
---------	-------------

1149F

front wire stripping pliers with cutting blade, self-adjusting



L mm	mm ²		
175	0,2 ÷ 6	1 011490010	

1150

combination pliers bright chrome-plated, slip-proof double layer PVC coated handles



ISO 5746

L mm	L1 mm	≠ mm	
160	37	1,6	5 011500006
180	41	1,8	5 011500008
200	45	2,0	5 011500010
220	50	2,0	2 011500012

1150BM

combination pliers bright chrome-plated, bi-material handles



ISO 5746

L mm	L1 mm	≠ mm	
160	37	1,6	3 011500036
180	41	1,8	3 011500038
200	45	2,0	3 011500040
220	50	2,0	2 011500042

1153

adjustable pliers, two positions, PVC-coated handles



UNI ISO 9343

L mm	L1 mm		
200	34	2 011530120	

1162

extra long flat knurled nose pliers, slip-proof double layer PVC coated handles



ISO 5745

L mm	L1 mm	≠ mm	
160	58	1,6	5 011620006
200	86	1,6	5 011620010

1162BM

extra long flat knurled nose pliers bi-material handles



ISO 5745

L mm	L1 mm	≠ mm	
160	58	1,6	3 011620036
200	86	1,6	3 011620040

Beta

1164

extra long bent flat knurled nose pliers,
slip-proof double layer PVC coated handles



ISO 5745

L	L1	mm		
mm	mm	mm		
160	54	1,6	5	011640006
200	76	1,6	5	011640010

1164BM

extra long bent flat knurled nose pliers,
bi-material handles



ISO 5745

L	L1	mm		
mm	mm	mm		
160	54	1,6	3	011640036
200	76	1,6	3	011640040

1166

extra long needle knurled nose pliers,
slip-proof double layer PVC coated handles



ISO 5745

L	L1	mm		
mm	mm	mm		
160	56	1,6	5	011660006
200	76	1,6	5	011660010

1166BM

extra long needle knurled nose pliers,
bi-material handles



ISO 5745

L	L1	mm		
mm	mm	mm		
160	56	1,6	3	011660036
200	76	1,6	3	011660040

1168

extra long bent needle knurled nose pliers,
slip-proof double layer PVC coated handles



ISO 5745

L	L1	mm		
mm	mm	mm		
160	54	1,6	5	011680006
200	76	1,6	5	011680010

1168BM

extra long bent needle knurled nose pliers,
bi-material handles

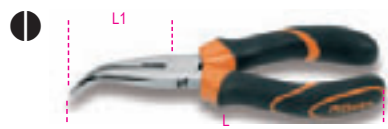

ISO 5745

L	L1	mm		
mm	mm	mm		
160	54	1,6	3	011680036
200	70	1,6	3	011680040

1171BM

smooth, flat short nose pliers
bi-material handles



ISO 9655

L	L1	A	B		
mm	mm	mm	mm		
125	18	12	8	2	011710101

1172BM

smooth, flat long nose pliers
bi-material handles



ISO 9655

L	L1	A	B		
mm	mm	mm	mm		
140	40	12	8	2	011720101

1172BM/P

smooth, flat bent long nose pliers
bi-material handles

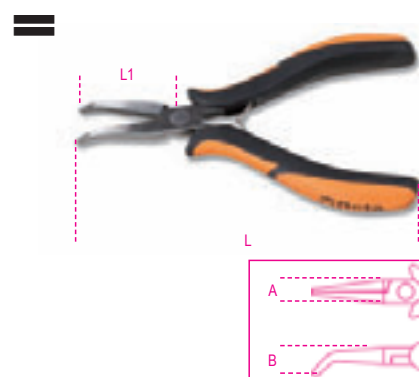

L	L1	A	B		
mm	mm	mm	mm		
140	38	12	13	2	011720102

1173BM

round short nose pliers
bi-material handles



ISO 9655

L	L1	A	B		
mm	mm	mm	mm		
125	22	12	8	2	011730101

1175BM

smooth half-round short nose pliers
bi-material handles



ISO 9655

L	L1	A	B		
mm	mm	mm	mm		
140	29	12	8	2	011750101

1177BM

smooth half-round long nose pliers
bi-material handles

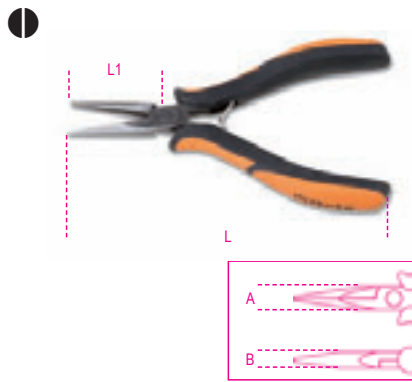

ISO 9655

L	L1	A	B
mm	mm	mm	mm
140	38	12	8

2 011770101

1177BM/Z

half-round long knurled nose pliers
bi-material handles

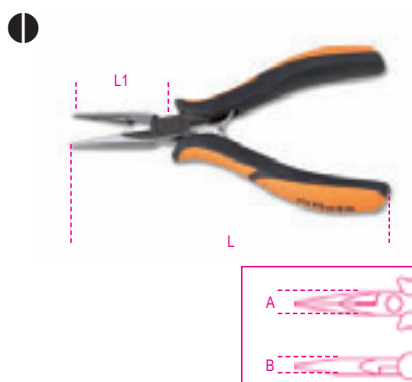

ISO 9655

L	L1	A	B
mm	mm	mm	mm
140	39	12	8

2 011770113

1178BM

smooth half-round long needle nose pliers
bi-material handles

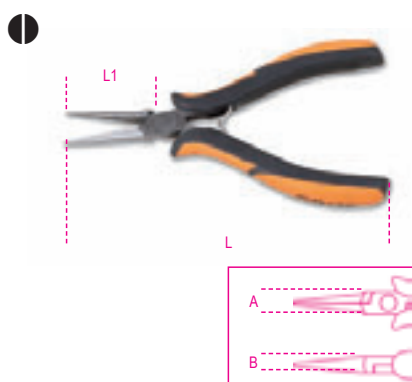

ISO 9655

L	L1	A	B
mm	mm	mm	mm
140	37	12	8

2 011780101

1178BM/P

smooth half-round long bent
needle nose pliers
bi-material handles

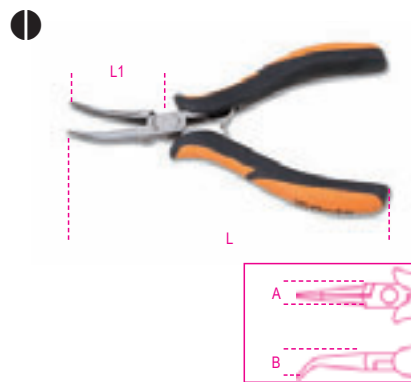

L	L1	A	B
mm	mm	mm	mm
140	36,5	12	12

2 011780102

1182BM

diagonal semi-flush cutting nippers,
slim tips
bi-material handles



ISO 9654

L	L1	A	Cu
mm	mm	mm	mm
120	11	10	1

2 011820101

1183BM

diagonal semi-flush cutting nippers,
rounded tips
bi-material handles



ISO 9654

L	L1	A	Cu
mm	mm	mm	mm
120	11	10	1

2 011830101

1184BM

diagonal flush cutting nippers,
rounded tips
bi-material handles



ISO 9654

L	L1	A	Cu
mm	mm	mm	mm
120	11	10	1
130	13	12,5	1,25

2 011840101
2 011840102

1185BM

diagonal flush cutting nippers,
slim tips
bi-material handles



ISO 9654

L	L1	A	Cu
mm	mm	mm	mm
120	11	10	1
130	13	12,5	1,25

2 011850101
2 011850102

1186BM

diagonal flush cutting nippers,
slim tapering tips
bi-material handles



ISO 9654

L	L1	A	Cu
mm	mm	mm	mm
120	11	10	1
130	13	12,5	1,25

2 011860101
2 011860102

1188BM

diagonal axial cutting nippers
bi-material handles



ISO 9654

L mm	L1 mm	A mm	Cu mm		
125	12	12	1,25	2	011880101
130	17	15	2	2	011880102

1190BM

end semi-flush cutting nippers
bi-material handles



ISO 9654

L mm	L1 mm	A mm	Cu mm		
120	12	12	1,25	2	011900113

1191BM

end flush oblique cutting nippers
bi-material handles



ISO 9654

L mm	L1 mm	A mm	Cu mm		
130	8	12	0,8	2	011910101

1191BM/L

end flush long oblique cutting nippers
bi-material handles



ISO 9654

L mm	L1 mm	A mm	Cu mm		
130	18	12	1	2	011910110

1191R/5-M

spare spring kit for pliers and nippers for
electronics, 5 pairs (items: 1171...1191)

1191R/5-M	1	011910995
-----------	---	-----------

1200MS

magnetizer/demagnetizer

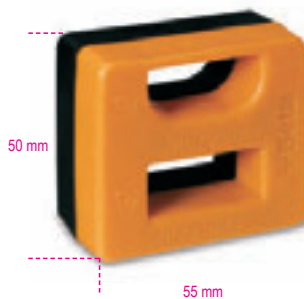

1200MS	5	012000000
--------	---	-----------



1201

screwdrivers for slotted head screws



ISO 2380

SxAxL mm	L1 mm	Ø mm		
0,4x2,5x50	146	2,5	5	012010003
0,4x2,5x75	166	2,5	5	012010006
0,5x3x75	171	3,0	5	012010009
0,5x3x100	196	3,0	5	012010012
0,6x3,5x75	171	3,5	5	012010018
0,6x3,5x100	196	3,5	5	012010021
0,8x4x100	196	4,0	5	012010030
0,8x4x125	221	4,0	5	012010033
0,8x4x150	246	4,0	5	012010036
1,0x5,5x100	209	5,0	5	012010039
1,0x5,5x125	234	5,0	5	012010040
1,0x5,5x150	259	5,0	5	012010042
1,2x6,5x100	220	6,0	5	012010048
1,2x6,5x125	234	6,0	5	012010050
1,2x6,5x150	270	6,0	5	012010051
1,2x8x150	282	8,0	3	012010057
1,2x8x200	332	8,0	3	012010060
1,6x10x200	332	9,5	3	012010066



1201/S6	1	012010206
---------	---	-----------

1201N

screwdrivers for slotted head screws,
extra-short series



ISO 2380

SxAxL mm	L1 mm	Ø mm		
0,8x4x30	86,5	4	3	012010103
1,2x6,5x30	86,5	6	3	012010106

1201DZ

screwdriver for Dzus® head screws

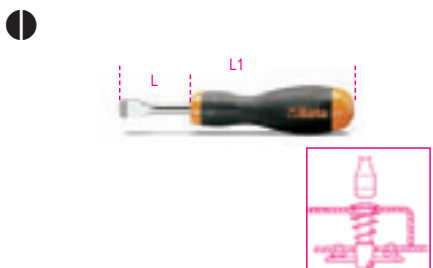

	L mm	L1 mm		
1201DZ	53	173	2	012010501

1202

screwdrivers for cross head
Phillips® screws



UNI/ISO 8764

PHxDxL mm	L1 mm		
0x3x60	156	5	012020003
0x3x100	200	5	012020006
1x4,5x80	189	5	012020009
1x4,5x120	229	5	012020012
2x6x100	220	5	012020018
2x6x150	270	5	012020021
3x8x150	282	3	012020024
4x9,5x200	332	3	012020027



1202/S4		1	012020204
PH0x3x60-PH1x4,5x120 PH2x6x150-PH3x8x150 mm			

1202N

screwdrivers
for cross head Phillips® screws,
extra-short series



UNI/ISO 8764

PHxDxL mm	L1 mm		
1x4,5x30	86,5	3	012020103
2x6x30	86,5	3	012020106

1202L

screwdrivers for cross head
Phillips® screws, long series



UNI/ISO 8764-1

PHxDxL mm	L1 mm		
0x3x300	400	3	012020303
1x4,5x300	400	3	012020305
1x4,5x400	508	3	012020306
2x6x400	519	3	012020309

1203/D

set of screwdrivers



1203/D5		1	012030001

1201	0,6x3,5x100-1,0x5,5x150 1,2x6,5x150 mm
1202	PH1x4,5x80-PH2x6x100 mm

1203/D7		1	012030007

1201	0,5x3x75-0,8x4x100 1,0x5,5x100-1,2x6,5x150 mm
1202	PH0x3x60-PH1x4,5x80 PH2x6x100 mm

1203/D8		1	012030008

1201	0,5x3x75-0,8x4x125 1,0x5,5x150-1,2x6,5x150 mm
1202	PH0x3x60-PH1x4,5x80 PH2x6x100-PH3x8x150 mm

1203/D10N		1	012030019

1201	2,5x50-3x75-4x100-5,5x150 6,5x150 mm
1201N	4x30 mm
1202	PH0x60-PH1x80-PH2x100 mm
1202N	PH1x30 mm

1203/D10		1	012030010

1201	0,4x2,5x50-0,5x3x75 0,8x4x100-1,0x5,5x100 1,2x6,5x150-1,2x8x150 mm
1202	PH0x3x60-PH1x4,5x80 PH2x6x100-PH3x8x150 mm

1203/D6		1	012030006

1202	PH1x4,5x80-PH2x6x100 mm
1204	0,4x2,5x60-0,5x3x100 0,8x4x100-1,0x5x125 mm

1203/D5PZ		1	012030003

1201	0,5x3x75-0,8x4x125 1,0x5,5x150 mm
1209PZ	PZ1x4,5x80-PZ2x6x100 mm

1203/S



1203/S8		1	012030009

1201	2,5x50-3x75-4x100-5,5x125- 6,5x150 mm
1202	PH0x3x60-PH1x4,5x80- PH2x6x100 mm



1203/S10		1	012030021

1201	0,4x2,5x50-0,5x3x75 0,8x4x125-1,0x5,5x150 1,2x6,5x150-1,2x8x150 mm
1202	PH0x3x60-PH1x4,5x80 PH2x6x100-PH3x8x150 mm



1204

screwdrivers for headless slotted screws



SxDxL mm	L1 mm		
0,4x2,5x60	156	5	012040003
0,6x3x75	175	5	012040006
0,5x3x100	196	5	012040009
0,8x4x100	196	5	012040012
0,8x4x125	233	5	012040015
1x5x125	234	5	012040018
1x5x150	258	5	012040021
1,2x6,5x150	270	5	012040024



1204/S5		1	012040205

0,4x2,5x60-0,5x3x100 0,8x4x100-1x5x125 1,2x6,5x150 mm

1204L

screwdrivers for headless slotted screws,
long series



SxAxL mm	L1 mm		
0,5x2,5x200	300	3	012040303
0,6x3x300	400	3	012040306
0,8x4x400	508	3	012040309
1x5x400	508	3	012040315
1,2x6,5x400	519	3	012040318

1205ES

hexagon drivers
with handles



mm	L mm	L1 mm		
1,5	100	200	3	012050315
2	100	200	3	012050320
2,5	100	200	3	012050325
3	100	200	3	012050330
4	100	208	3	012050340
5	100	219	3	012050350
6	125	244	3	012050360
8	150	277	2	012050380

1207TX

screwdrivers for Torx® head screws,
with handles



	L mm	L1 mm	Ø mm		
T5	50	150	3	5	012070005
T6	60	156	4	5	012070006
T7	60	156	4	5	012070007
T8	60	156	4	5	012070008
T9	60	156	4	5	012070009
T10	80	189	5	5	012070010
T15	80	189	5	5	012070015
T20	100	209	5	5	012070020
T25	100	209	5	5	012070025
T27	100	220	6	5	012070027
T30	100	220	6	5	012070030
T40	130	262	7	2	012070040
T45	130	262	8	2	012070045



1207TX/D7
T6-T8-T10-T15
T20-T25-T30

1208RTX

screwdrivers for Tamper Resistant Torx®
head screws, with handles



Ø	L mm	L1 mm	Ø mm		
T9	60	156	4	5	012080009
T10	80	189	5	5	012080010
T15	80	189	5	5	012080015
T20	100	209	5	5	012080020
T25	100	209	5	5	012080025
T27	100	220	6	5	012080027
T30	100	220	6	5	012080030
T40	130	262	7	2	012080040



1208RTX/D7
T9-T10-T15-T20
T25-T27-T30

1209PZ

screwdrivers for cross head
Pozidriv®-Supadriv® screws



UNI/ISO 8764

PZ	L mm	L1 mm		
0	60	156	5	012090000
1	80	189	5	012090003
2	100	220	5	012090006
3	150	282	3	012090009
4	200	327	3	012090012



1209PZ/S4
PZ0-PZ1-PZ2-PZ3

1209N/PZ

screwdrivers for cross head
Pozidriv®-Supadriv® screws,
extra-short series



PZ	L mm	L1 mm		
1	30	87	3	012090103
2	30	87	3	012090106



1229LP

micro-screwdrivers
for headless slotted screws

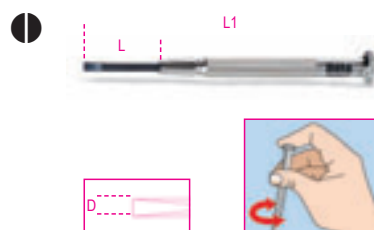

D mm	L mm	L1 mm		
1,0	17	75	5	012290210
1,2	21	85	5	012290212
1,4	21	89	5	012290214
1,8	23	94	5	012290218
2,0	23	98	5	012290220
2,4	26	103	5	012290224
3,0	28	108	5	012290230



1229LP/A6
1,2-1,4-1,8-2-2,4-3 mm

1229PH

micro-screwdrivers for cross head
Phillips® screws

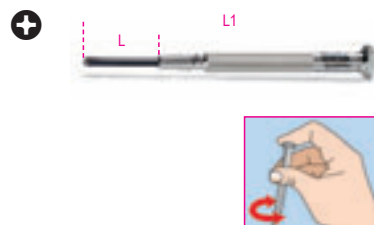

PH	L mm	L1 mm		
0	26	102	5	012290250
1	29	107	5	012290251

1229LPH/A6

set of 6 micro-screwdrivers
items 1229LP-1229PH



1229LPH/A6
1229LP 1,4-2,0-2,4-3 mm
1229PH PH0-PH1

1236B

offset screwdrivers
for slotted head screws

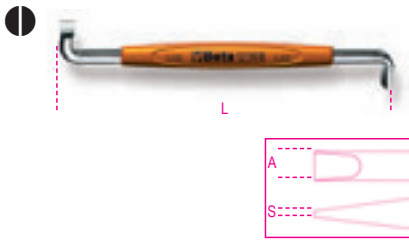

UNI 7079 DIN 5200

SxA mm	L mm		
0,8x4	100	5	012360201
1x5,5	125	5	012360202
1,2x8	150	5	012360204

1238B

offset screwdrivers
for cross head Phillips® screws



UNI 7083 DIN 5208

PH	L mm		
1-2	125	5	012380201
3-4	200	5	012380203

1241

screwdrivers with steel head for slotted head screws



SxAxL mm	L1 mm		
1x5,5x100	202	5	012410039
1,2x6,5x125	240	5	012410050
1,2x8x150	268	3	012410057
1,6x10x200	325	2	012410066

1242

screwdrivers with steel head for cross head Phillips® screws

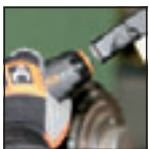

UNI/ISO 8764

PHxDxL mm	L1 mm		
1x4,5x100	202	5	012420209
2x6x100	215	5	012420218
3x8x150	268	3	012420221
4x11x200	325	2	012420224

1243/D7

Set of 7 screwdrivers with steel heads



1243/D7

1241 1x5,5x100-1,2x6,5x125
1,2x8x150-1,6x10x200 mm
1242 PH1x4,5x100-PH2x6x100
PH3x8x150 mm

1 012430017

1250

screwholding screwdrivers
for slotted head screws



SxDxL mm	L1 mm		
0,5x3x125	190	5	012500030
0,6x4x125	225	5	012500040
0,7x5x150	255	5	012500050

1251

screwholding screwdrivers
for cross head Phillips® screws



PHxDxL mm	L1 mm		
0x4x125	225	5	012510000
1x5x150	255	5	012510010
2x6x175	280	5	012510020

1252/S5



1252/S5

1250 0,5x3x125-0,6x4x125
0,7x5x150 mm
1251 PH1x5x150-PH2x6x175 mm

1 012520001

1253

mains testing screwdriver 150/250V

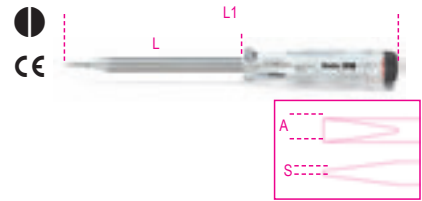

SxAxL mm	L1 mm		
0,5x3,5x100	190	5	012530001

1253A

mains testing screwdriver 125/250V,
double insulation



SxAxL mm	L1 mm		
0,5x3x15	150	5	012530010

1254

circuit testing screwdriver 6-24V

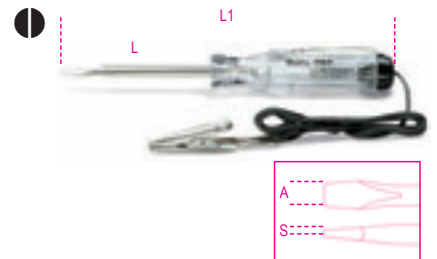

SxAxL mm	L1 mm		
0,5x3x44	123	5	012540001

1256/C36-2

microscrewdriver with 36 interchangeable
4-mm bits and magnetic extension



1256/C36-2		1	012560100

	1256TX	T3 - T4 - T5 - T6 - T7 T8 - T9 - T10 - T15
	1256RTX	T6 - T7 - T8 - T9 - T10
	1256LP	0,8 - 1,2 - 1,5 - 1,8 - 2 - 2,5 3 - 3,5 - 4 mm
	1256PE	0,7 - 0,9 - 1,3 - 1,5 - 2 mm
	1256PH	PH000 - PH00 - PH0 - PH1
	1256PZ	PZ000 - PZ00 - PZ0 - PZ1
	1256/20	
	1256/30	

130x60x35 mm - 200 g

1256LP

4-mm bits
for slotted head screws

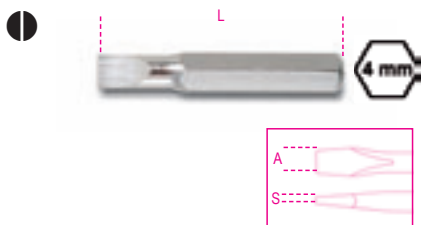

SxA mm	L mm	5	1
0.25x0.8	27	5	012560001
0.25x1.2	27	5	012560002
0.3x1.5	27	5	012560003
0.35x1.8	27	5	012560004
0.4x2.0	27	5	012560005
0.4x2.5	27	5	012560006
0.5x3.0	27	5	012560007
0.6x3.5	27	5	012560008
0.8x4.0	27	5	012560009

1256PH

4-mm bits
for cross head Phillips® screws



PH mm	L mm	5	1
000	27	5	012560011
00	27	5	012560012
0	27	5	012560013
1	27	5	012560014

1256PZ

4-mm bits
for slotted head Pozidriv® - Supradriv® screws



PZ mm	L mm	5	1
000	27	5	012560061
00	27	5	012560062
0	27	5	012560063
1	27	5	012560064

1256PE

4-mm bits
for hexagon head screws



mm	L mm	5	1
0.7	27	5	012560021
0.9	27	5	012560022
1.3	27	5	012560023
1.5	27	5	012560024
2.0	27	5	012560025

1256TX

4-mm bits
for Torx® head screws



T	L mm	5	1
T3	27	5	012560041
T4	27	5	012560042
T5	27	5	012560043
T6	27	5	012560044
T7	27	5	012560045
T8	27	5	012560046
T9	27	5	012560047
T10	27	5	012560048
T15	27	5	012560049

1256RTX

4-mm bits
for Tamper Resistant Torx® head screws



T	L mm	5	1
T6	27	5	012560051
T7	27	5	012560052
T8	27	5	012560053
T9	27	5	012560054
T10	27	5	012560055

1256/20

hexagon drive extension, 4 mm



1256/20	5	1	012560092
---------	---	---	-----------

1256/30

4-mm bit holder with handle



L mm	2	1	012560097
110			

1257LP

micro-screwdrivers
for slotted head screws



SxD mm	L mm	5	1
0.2x1.2	60	5	012570012
0.25x1.5	60	5	012570015
0.3x1.8	60	5	012570018
0.4x2	60	5	012570020
0.4x2.5	60	5	012570024
0.5x3	60	5	012570030
0.6x3.5	60	5	012570035
0.8x4	60	5	012570040

1257PH

micro-screwdrivers
for cross-head Phillips® screws



PH	L mm	5	1
00	60	5	012570060
0	60	5	012570063
1	60	5	012570066

1257LPH/S8



1257LPH/S8	1	1	012570210
1257PH	PH00-PH0-PH1		
1257LP	0.4x2-0.4x2.5-0.5x3 0.6x3.5-0.8x4 mm		

1257ES

micro-screwdrivers hexagon male ends



mm	L mm	5	1
0.9	60	5	012570045
1.3	60	5	012570046
1.5	60	5	012570047
2	60	5	012570048
2.5	60	5	012570049
3	60	5	012570050

1257ESB/S8



1257ESB/S8		1	012570230
1257ES	0,9-1,3-1,5-2-2,5-3 mm		
1257BE	4-5 mm		

1257TX

micro-screwdrivers for Torx® head screws



⊕	L		
mm	mm		
T5	60	5	012570075
T6	60	5	012570076
T7	60	5	012570077
T8	60	5	012570078
T9	60	5	012570079
T10	60	5	012570080
T15	60	5	012570081
T20	60	5	012570082



1257TX/S8		1	012570220
T5-T6-T7-T8			
T9-T10-T15-T20			

1257BE

micro-screwdrivers hexagon socket wrenches



⊕	L		
mm	mm		
3,2	60	5	012570085
4	60	5	012570086
5	60	5	012570087
5,5	60	5	012570088

1260

screwdrivers for slotted head screws



ISO 2380

SxAxL	L1	Ø		
mm	mm	mm		
0,4x2,5x50	150	2,5	5	012600003
0,4x2,5x75	175	2,5	5	012600006
0,5x3x75	175	3,0	5	012600009
0,5x3x100	200	3,0	5	012600012
0,6x3,5x75	175	3,5	5	012600018
0,6x3,5x100	200	3,5	5	012600021
0,8x4x100	208	4,0	5	012600030
0,8x4x125	233	4,0	5	012600033
0,8x4x150	258	4,0	5	012600036
1x5,5x100	208	5,0	5	012600039
1x5,5x125	233	5,0	5	012600040
1x5,5x150	258	5,0	5	012600042
1,2x6,5x100	219	6,0	5	012600048
1,2x6,5x125	244	6,0	5	012600050
1,2x6,5x150	269	6,0	5	012600051
1,2x8x150	277	8,0	3	012600057
1,2x8x200	327	8,0	3	012600060
1,6x10x200	327	9,5	3	012600066
2x12x250	377	10	3	012600069
2x14x250	377	10	2	012600073



1260/S6		1	012600306
0,4x2,5x75-0,5x3x75-0,8x4x125			
1x5,5x150-1,2x6,5x150-1,2x8x200 mm			

1260N

screwdrivers for slotted head screws, extra-short series



ISO 2380

SxAxL	L1	Ø		
mm	mm	mm		
0,8x4x30	87	4	5	012600103
1,2x6,5x30	87	6	5	012600106

1260E

screwdrivers for slotted head screws with hexagon bolsters



ISO 2380

SxAxL	L1	Ø		
mm	mm	mm		
1,2x6,5x150	269	6,0	3	012600156
1,2x8x175	301	8,0	3	012600157
1,6x10x200	327	9,5	2	012600159
2x12x250	377	9,5	2	012600162

1262

screwdrivers for cross head Phillips® screws



UNI/ISO 8764

PHxDxL	L1		
mm	mm		
0x3x60	160	5	012620003
0x3x100	200	5	012620006
1x4,5x80	188	5	012620009
1x4,5x120	228	5	012620012
2x6x100	219	5	012620018
2x6x150	269	5	012620021
3x8x150	277	3	012620024
4x10x200	327	3	012620027



1262/S4		1	012620304
PH0x3x60-PH1x4,5x80			
PH2x6x100-PH3x8x150 mm			

1262N

screwdrivers for cross head Phillips® screws, extra-short series



UNI/ISO 8764

PHxDxL	L1		
mm	mm		
1x4,5x30	87	5	012620103
2x6x30	87	5	012620106

1262E

screwdrivers
for cross head Phillips® screws
with hexagon bolsters



UNI/ISO 8764

PHxDxL mm	L1 mm		
2x6x150	269	3	012620153
3x8x175	302	3	012620156
4x10x200	327	2	012620159

1262L

screwdrivers
for cross head Phillips® screws,
long series



UNI/ISO 8764-1

PHxDxL mm	L1 mm		
0x3x300	400	3	012620203
1x4,5x300	400	3	012620205
1x4,5x400	508	3	012620206
2x6x400	519	3	012620209

1263/D...

set of screwdrivers



1263/D6			
1262	PH0x3x60-PH1x4,5x80 PH2x6x100 mm	1	012630006
1264	0,5x2,5x60-0,6x3x100 0,8x4x125-1x5x125 mm		



1263/D7			
1262	PH0x3x60-PH1x4,5x80 PH2x6x100 mm	1	012630017
1264	0,5x2,5x60-0,6x3x100 0,8x4x125-1x5x125 mm		



1263/D7PZ			
1260	0,5x3x75-0,8x4x100 1x5,5x150-1,2x6,5X150 mm	1	012630007
1269PZ	PZ0 - PZ1 - PZ2		



1263/D8			
1260	0,4x2,5x50-0,5x3x75 0,8x4x100-1x5,5x125 1,2x6,5X150 mm	1	012630008
1262	PH0x3x60-PH1x4,5x80 PH2x6x100 mm		



1263/D10			
1260	0,5x3x75-0,6x3,5x100 0,8x4x125-1x5,5x150 1,2x6,5X150 mm	1	012630010
1260N	0,8x4x30		
1262	PH0x3x60-PH1x4,5x80 PH2x6x100 mm		
1262N	PH1x4,5x30		

1263/S12

set of 12 screwdrivers



1263/S12			
1260	0,4x2,5x50-0,5x3x75 0,6x3,5x100-0,8x4x125 1x5,5x125-1,2x6,5x150 1,2x8x200-1,6x10x200 mm	1	012630112
1262	PH0x3x60-PH1x4,5x80 PH2x6x100-PH3x8x150 mm		

1264

screwdrivers for headless slotted screws



SxDxL mm	L1 mm		
0,5x2,5x60	160	5	012640003
0,6x3x75	175	5	012640006
0,6x3x100	200	5	012640009
0,8x4x100	208	5	012640012
0,8x4x125	233	5	012640015
1x5x125	233	5	012640018
1x5x150	258	5	012640021
1,2x6,5x150	269	5	012640024



1264/S5			
1260	0,5x2,5x60-0,6x3x75 0,8x4x100-1x5x125-1,2x6,5x150 mm	1	012640305

1264L

screwdrivers for headless slotted screws,
long series



SxDxL mm	L1 mm		
0,5x2,5x200	300	3	012640203
0,6x3x300	400	3	012640206
0,8x4x400	508	3	012640209
1x5x400	508	3	012640215
1,2x6,5x400	519	3	012640218

1265ES

hexagon drivers
with handles



mm	L mm	L1 mm		
1,5	100	200	3	012650015
2	100	200	3	012650020
2,5	100	200	3	012650025
3	100	200	3	012650030
4	100	208	3	012650040
5	100	219	3	012650050
6	125	244	3	012650060
8	150	277	2	012650080



1265ES/S8			
1,5-2-2,5-3-4-5-6-8 mm	1	012650308	

1266BP

ball head hexagon drivers
with handles



mm	L mm	L1 mm		
2	100	200	3	012660020
2,5	100	200	3	012660025
3	125	225	3	012660030
4	125	233	3	012660040
5	120	239	3	012660050
6	140	259	3	012660060
8	160	287	2	012660080
10	160	287	2	012660100



1266BP/S8
2-2,5-3-4-5-6-8-10 mm

1 012660308

1267TX

drivers for Torx® head screws,
with handles



	L mm	L1 mm	Ø mm	
T5	50	150	3	5 012670005
T6	50	150	3	5 012670006
T7	50	150	3	5 012670007
T8	60	160	3	5 012670008
T9	60	167	4	5 012670009
T10	80	188	4	5 012670010
T15	80	188	4	5 012670015
T20	100	208	4,5	5 012670020
T25	100	208	5	5 012670025
T27	115	234	6	5 012670027
T30	115	234	6	5 012670030
T40	130	257	7	2 012670040
T45	130	257	8	2 012670045



1267TX/D7
T6-T8-T10-T15
T20-T25-T30

1 012670307



1267TX/S13
T5-T6-T7-T8-T9
T10-T15-T20-T25
T27-T30-T40-T45

1 012670312

1268RTX

screwdrivers for Tamper Resistant Torx® head
screws, with handles



	L mm	L1 mm	Ø mm	
T9	60	167	4,0	3 012680009
T10	80	188	4,0	3 012680010
T15	80	188	4,0	3 012680015
T20	100	208	4,5	3 012680020
T25	100	208	5,0	3 012680025
T27	115	234	6,0	3 012680027
T30	115	234	6,0	3 012680030
T40	130	257	7,0	2 012680040



1268RTX/S8
T9-T10-T15-T20
T25-T27-T30-T40

1 012680307

1269PZ

screwdrivers for cross head
Pozidriv®-Supadriv® screws



UNI/ISO 8764

	L mm	L1 mm	
PZ 0	60	160	5 012690000
1	80	188	5 012690001
2	100	219	5 012690002
3	150	277	3 012690003
4	200	327	3 012690004



1269PZ/S4
PZ0-PZ1-PZ2-PZ3

1 012690304

1269N/PZ

screwdrivers for cross head
Pozidriv®-Supadriv® screws,
extra-short series



UNI/ISO 8764

	L mm	L1 mm	
PZ 1	30	87	5 012690011
2	30	87	5 012690012

1281BG

interchangeable blade screwdriver handle



L
mm 118
mm 10
5 012810280

1281PM

quick-fit magnetic bit holder



L
mm 165
5 012810292

1281PB

socket holder with 1/4" male drive



L
mm 175
5 012810293

1281LP

reversible screwdrivers
for slotted head screws



1281LP/1
0,8x4-1,2x6,5 mm
1281LP/2
1x5,5-1,2x6,5 mm
5 012810302
5 012810304

1281PH

reversible screwdrivers
for cross head Phillips® screws



PH		
1-2	5	012810310
2-3	5	012810312

1281LPH

reversible screwdrivers
for slotted and Phillips® head screws



1281LPH/1	5	012810321
PH0-0,8x4 mm		
1281LPH/2	5	012810322
PH1-1x5,5 mm		
1281LPH/3	5	012810323
PH2-1,2x6,5 mm		

1281PZ

reversible screwdrivers
for cross head Pozidriv®-Supadriv® screws



PZ		
1-2	5	012810330
2-3	5	012810332

1281PE

reversible ball head hexagon
screwdriver blades



mm		
2,5	5	012810342
3	5	012810343
4	5	012810344
5	5	012810345
6	5	012810346

1281TX

reversible screwdrivers for Torx® head screws



1281TX/1	5	012810349
T6-T8		
1281TX/2	5	012810350
T7-T9		
1281TX/3	5	012810351
T10-T15		
1281TX/4	5	012810352
T20-T25		
1281TX/5	5	012810353
T30-T40		

1281RTX

reversible screwdrivers
for Tamper Resistant Torx® head screws



1281RTX/3	5	012810361
T10-T15		
1281RTX/4	5	012810362
T20-T25		
1281RTX/5	5	012810363
T30-T40		

1281BG/A9

assortment of 9 reversible screwdrivers
and 1 accessory in case



1281BG/A9	1	012810520
-----------	---	-----------

1281BG		
1281LPH/1	PH0-0,8x4 mm	
1281LPH/2	PH1-1x5,5 mm	
1281LPH/3	PH2-1,2x6,5 mm	
1281PZ/1	PZ1-PZ2	
1281PE	2,5 mm	
1281PE	3 mm	
1281PE	4 mm	
1281PE	5 mm	
1281PE	6 mm	

1281BG-TX/A8

assortment of 8 reversible screwdrivers
and 1 accessory in case



1281BG-TX/A8	1	012810530
--------------	---	-----------

1281BG		
1281LPH/1	PH0-0,8x4 mm	
1281LPH/2	PH1-1x5,5 mm	
1281LPH/3	PH2-1,2x6,5 mm	
1281TX/1	T6-T8	
1281TX/2	T7-T9	
1281TX/3	T10-T15	
1281TX/4	T20-T25	
1281TX/5	T30-T40	

1281BG/B28A

set of 16 reversible screwdrivers,
9 1/4" drive sockets,
2 accessories and 1 handle, in wallet



1281BG/B28A	1	012810510
-------------	---	-----------

900	4 - 4,5 - 5 - 5,5 6 - 7 - 8 - 9 - 10 mm
1281BG	
1281PB	1/4
900/25	
1281LP/1	0,8x4 - 1,2x6,5 mm
1281LP/2	1,0x5,5 - 1,2x6,5 mm
1281PH/1	PH1 - PH2
1281PH/2	PH2 - PH3
1281PZ/1	PZ1 - PZ2
1281PZ/2	PZ2 - PZ3
1281PE	2,5 - 3 - 4 - 5 - 6 mm
1281TX/1	T6 - T8
1281TX/2	T7 - T9
1281RTX/3	T10 - T15
1281RTX/4	T20 - T25
1281RTX/5	T30 - T40

1281/BV	1	012810501
---------	---	-----------

1290

screwdrivers for slotted head screws

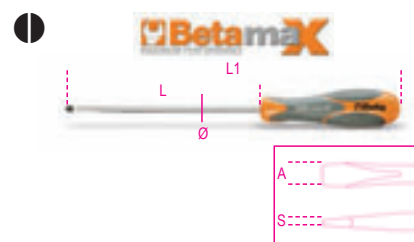

ISO 2380

SxAxL mm	L1 mm	Ø mm	
0,4x2,5x50	146	2,5	5 012900003
0,4x2,5x75	171	2,5	5 012900006
0,5x3x75	171	3,0	10 012900009
0,5x3x100	196	3,0	10 012900012
0,6x3,5x75	171	3,5	10 012900018
0,6x3,5x100	196	3,5	10 012900021
0,8x4x100	196	4,0	10 012900030
0,8x4x125	221	4,0	10 012900033
0,8x4x150	246	4,0	10 012900036
1x5,5x100	209	5,0	10 012900039
1x5,5x150	259	5,0	10 012900042
1,2x6,5x100	220	6,0	10 012900048
1,2x6,5x150	270	6,0	10 012900051
1,2x8x150	282	7,0	3 012900057
1,2x8x200	332	7,0	3 012900060
1,6x10x200	332	8,0	3 012900066
2x12x250	382	10	2 012900069

1290/S...

screwdriver set



1290/S5	1	012900305
---------	---	-----------

1290 0,5x3x75-0,8x4x100 -1x5,5x150
1,2x6,5x150 -1,2x8x150 mm

1290/S9X	1	012900319
----------	---	-----------

1290 0,4x2,5x75 - 0,5x3,5x100
0,8x4x125 - 1x5,5x150
1,2x6,5x150 - 1,2x8x200
1,6x10x200 mm

1290N 0,8x4x30 -1,2x6,5x30 mm

1290N

screwdrivers for slotted head screws
extra short series



ISO 2380

SxAxL mm	L1 mm	Ø mm	
0,8x4x30	86	4	5 012900103
1,2x6,5x30	86	6	5 012900106

1292

screwdrivers for cross head
Phillips® screws



UNI/ISO 8764

PHxDxL mm	L1 mm	
0x3x60	156	10 012920003
0x3x100	196	5 012920006
1x4,5x80	189	10 012920009
1x4,5x120	229	10 012920012
2x6x100	220	10 012920018
2x6x150	270	10 012920021
3x8x150	282	3 012920024
4x10x200	332	3 012920027



1292/S4
PH0x3x60-PH1x4,5x80
PH2x6x100-PH3x8x150 mm

1 012920304

1292N

screwdrivers for cross head
Phillips® screws
extra short series



UNI/ISO 8764

PHxDxL mm	L1 mm	
1x4,5x30	86	5 012920103
2x6x30	86	5 012920106

1292L

screwdrivers for cross head
Phillips® screws, long series

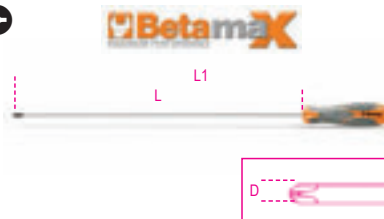

UNI/ISO 8764-1

PHxDxL mm	L1 mm	
0x3x300	396	3 012920203
1x4,5x400	509	3 012920206
2x6x400	520	3 012920209

1293/D...

screwdriver set



1293/D6 1 012930401

1290 0,6x3,5x75-1x5,5x150
1,2x6,5x150 mm

1292 PH0x3x60 -PH1x4,5x80
PH2x6x100 mm



1293/D8 1 012930403

1290 0,5x3x75-0,8x4x100
1x5,5x150-1,2x6,5x150
1,2x8x150 mm

1292 PH0x3x60 -PH1x4,5x80
PH2x6x100 mm

1293/S...

screwdriver set



1293/S8 1 012930208

1290 2,5x50-3x75-4x100-5,5x150
6,5x150 mm

1292 PH0x3x60-PH1x4,5x80
PH2x6x100 mm



1293/S10 1 012930201

1290 0,4x2,5x50 -0,6x3,5x100
1x5,5x100-1,2x6,5x150
1,2x8x150-1,6x10x200 mm

1292 PH0x3x60 -PH1x4,5x80
PH2x6x100-PH3x8x150 mm



1293/S12 1 012930203

1290 0,5x3x75-0,8x4x125
1x5,5x150-1,2x6,5x150
1,2x8x200 mm

1290N 0,8x4x30 mm

1292 PH0x3x60 -PH1x4,5x80
PH2x6x100-PH3x8x150 mm

1292N PH1x4,5x30-PH2x6x30 mm



1293/S7 1 012930207

1292 PH0x3x60 -PH1x4,5x80
PH2x6x100 mm

1294 0,5x2,5x60-0,6x3x75
0,8x4x100-1x5x125 mm

1293ES

hexagon drivers with handles



mm	L mm	L1 mm	Ø mm		
2	100	196	3	5	012930001
2,5	100	196	4	5	012930002
3	100	196	4	5	012930003
4	100	196	5	5	012930004
5	100	209	6	5	012930005
6	125	245	7	5	012930006
8	150	282	10	2	012930008



1293ES/S7

2-2,5-3-4-5-6-8 mm

1 012930057

1293BP

ball head hexagon drivers with handles



mm	L mm	L1 mm		
2	100	196	5	012930501
2,5	100	196	5	012930502
3	100	196	5	012930503
4	100	196	5	012930506
5	100	209	5	012930509
6	125	245	5	012930512
8	150	282	2	012930515



1293BP/S7

2-2,5-3-4-5-6-8 mm

1 012930558

1294

screwdrivers for headless slotted screws



SxDxL mm	L1 mm		
0,5x2,5x60	156	5	012940003
0,6x3x75	171	5	012940006
0,6x3x100	196	5	012940009
0,8x4x100	196	5	012940012
0,8x4x150	246	5	012940015
1x5x125	234	5	012940018
1,2x6,5x150	282	5	012940027



1294/S5

0,5x2,5x60-0,6x3x100
0,8x4x100-1x5x125
1,2x6,5x150 mm

1 012940305

1294L

screwdrivers for headless slotted screws
long series



SxDxL mm	L1 mm		
0,6x3x300	396	3	012940206
0,8x4x400	496	3	012940209
1x5x400	509	3	012940215
1,2x6,5x400	532	3	012940218

1295

impact screwdriver



L
mm
130

1 012950001

1295/C14

impact screwdriver
with 14 insets and 1 socket holder



1295/C14

1 012950108

	866LP	1,2x6,5 - 1,6x10 mm
	866PH	PH2 - PH3
	866PZ	PZ2 - PZ3
	866PE	5 - 6 mm
	866TX	T27 - T30 - T40 - T45 - T50 - T55
	895/6	□ 1/2 - □ 5/16
	1295	■ 1/2

170x100x35 mm - 1,3 kg

1297TX

drivers for Torx® head screws,
with handles



	L mm	L1 mm	Ø mm		
T6	50	146	3,0	5	012970006
T7	50	146	3,0	5	012970007
T8	60	156	3,0	5	012970008
T9	60	169	4,0	5	012970009
T10	80	189	4,0	5	012970010
T15	80	189	4,0	5	012970015
T20	100	209	4,5	5	012970020
T25	100	209	5,0	5	012970025
T27	115	235	6,0	5	012970027
T30	115	235	6,0	5	012970030
T40	130	262	7,0	2	012970040
T45	130	262	8,0	2	012970045



1297TX/S12
T6-T7-T8-T9-T10
T15-T20-T25-T27
T30-T40-T45

1 012970312

Beta

**Betamax**

1 012970409

1297TX/D6
 T10-T15-T20
 T25-T27-T30
1298RTX
 screwdrivers for Tamper Resistant Torx®
 head screws, with handles
**Betamax**

5 012980009

	L mm	L1 mm	Ø mm
T9	60	169	4,0
T10	80	189	4,0
T15	80	189	4,0
T20	100	209	4,0
T25	100	209	4,5
T27	115	235	5,5
T30	115	235	6,0
T40	130	262	7,0

1 012980308

1298RTX/S8
 T9-T10-T15-T20
 T25-T27-T30-T40
1299PZ
 screwdrivers for cross head
 Pozidriv®-Supadriv® screws
**Betamax**

5 012990000

PZ	L mm	L1 mm
0	60	156
1	80	189
2	100	220
3	150	282
4	200	332

1 012990306

**Betamax**
1299PZ/S6
 1299PZ PZ0-PZ1-PZ2-PZ3
 1299N/PZ PZ1-PZ2
1299N/PZ
 screwdrivers for cross head
 Pozidriv®-Supadriv® screws
 extra short series
**Betamax**

UNI/ISO 8764

PZ	L mm	L1 mm
1	30	86
2	30	86

1365P10

oil pressure pump

1.5-m-long hose, 1/2" coupling



1 013650110

1370

engineer's hammers, wooden shaft

**HICKORY**

UNI 7778 DIN 1041

	A mm	L mm	L1 mm
100	15	260	82
200	19	280	95
300	23	300	105
400	25	310	112
500	27	320	118
600	30	330	122
800	33	350	130
1000	36	360	135
1500	42	380	145
2000	47	400	155

1370/MR...

spare shafts for item 1370



1370MR 100	4 013700081
1370/100	
1370MR 200	4 013700082
1370/200	
1370MR 300	4 013700083
1370/300	
1370MR 400	4 013700084
1370/400	
1370MR 500	4 013700085
1370/500	
1370MR 600	4 013700086
1370/600	
1370MR 800	4 013700088
1370/800	
1370MR 1000	4 013700090
1370/1000	
1370MR 1500	4 013700095
1370/1500	
1370MR 2000	4 013700100
1370/2000	

1370Tmechanic's hammers
fibre shaft

	A mm	L mm	L1 mm
200	19	280	95
300	23	300	105
500	27	320	118
800	33	350	130
1000	36	360	135
1500	42	365	145

1370F

riveting hammers, wooden shaft

**HICKORY**

NF E 71.014

A mm	L mm	L1 mm	g
24	260	77	280
26	260	80	310
28	280	86	400
30	280	92	450
32	300	100	550
36	300	104	720
40	330	110	1065
42	330	116	1080
50	380	138	1760
60	380	160	2585

1370F/MR...

spare shafts for item 1370F



1370F/MR 24 1370F/24-26	2	013700474
1370F/MR 28 1370F/28-30	2	013700478
1370F/MR 32 1370F/32-36	2	013700482
1370F/MR 40 1370F/40-42	2	013700490
1370F/MR 50 1370F/50	2	013700495
1370F/MR 60 1370F/60	2	013700496

1370FT

riveting hammers, fibre shafts



A	L	L1	g
mm	mm	mm	g
28	280	86	530
30	280	92	625
32	300	100	750
36	300	104	930
40	330	110	1150
42	330	116	1250
50	380	138	2100
60	380	160	2750

1374F

carpenter's hammers, wooden shaft



NF E 71.012

HICKORY

A	L	L1	g
mm	mm	mm	g
16	250	80	180
20	270	86	250
22	290	92	335
26	290	103	425
28	310	108	510
30	310	117	580

1374F/MR...

spare shafts for item 1374F



1374F/MR 16 1374F/16	2	013740456
1374F/MR 20 1374F/20	2	013740460
1374F/MR 22 1374F/22-26	2	013740462
1374F/MR 28 1374F/28	2	013740468
1374F/MR 30 1374F/30	2	013740470

1375

claw hammer, wooden shaft



L1	Ø	L
mm	mm	mm
95	25	300

1375/MR

spare shafts for item 1375



1375/MR	2	013750003
---------	---	-----------

1375A

claw hammers, plastic shafts



L	L1
mm	mm
450	330
570	330

1375B

claw hammers, steel shafts



L	L1
mm	mm
450	330
570	330

1376X

claw hammers with square peins, magnets and nail holders wooden shaft



A	L1	L
mm	mm	mm
20	125	450
25	130	450
27	132	450

1376X/MR

spare shaft for item 1376X



1376X/MR	2	013760161
----------	---	-----------

1376XT

claw hammers with square peins, magnets and nail holders plastic shaft



A	L1	L
mm	mm	mm
20	125	500
25	130	500
27	132	500

1376XT/MR

spare shaft for item 1376XT



1376MR/XT	2	013760585
-----------	---	-----------

1377

ball pein hammers, round heads, for coppersmiths and tinsmiths, wooden shafts



HICKORY

L	L1
mm	mm
330	95
350	102
350	110
360	116
380	120

1377/MR...

spare shafts for item 1377



1377MR 340 1377/340	2	013770234
1377MR 450 1377/450	2	013770245
1377MR 570 1377/570	2	013770257
1377MR 680 1377/680	2	013770268
1377MR 900 1377/900	2	013770290

1378

joiner's hammers, round heads and peins, wooden shaft



HICKORY

g	L mm	L1 mm	Ø mm		
340	330	100	27	2	013780134
570	350	115	32	2	013780157

1378/MR...

spare shafts for item 1378



1378MR 340 1378/340	2	013780234
1378MR 570 1378/570	2	013780257

1379F

electrician's hammers, wooden shafts



HICKORY

A mm	L mm	L1 mm		
16	250	126	2	013790416
18	250	135	2	013790418
20	260	142	2	013790420

1379F/MR...

spare shafts for item 1379F



1379F/MR 16 1379F/16-18	2	013790426
1379F/MR 20 1379F/20	2	013790430

1380

lump hammers, wooden shafts



HICKORY

UNI 7777 DIN 6475

g	A mm	L mm	L1 mm		
800	38	260	90	2	013800208
1000	40	260	95	2	013800210
1250	43	260	100	2	013800212
1500	45	280	110	2	013800215
2000	50	300	120	2	013800220

1380/MR...

spare shafts for item 1380



1380MR 800 1380/800-1000-1250	2	013800238
1380MR 1500 1380/1500	2	013800245
1380MR 2000 1380/2000	2	013800250

1380S

mason club hammers with security collars
wooden shafts



g	A mm	L mm	L1 mm		
800	36	260	90	2	013800400
1000	39	260	95	2	013800405
1250	43	260	100	2	013800410
1500	45	260	110	2	013800415

1380S/MR...

spare shafts for item 1380S



1380S/MR 800 1380S/800-1000-1250	2	013800417
1380S/MR 1500 1380S/1500	2	013800419

1380T

Mason club hammers,
fibre shafts



g	A mm	L mm	L1 mm		
800	35	260	85	2	013800308
1000	40	260	100	2	013800310
1250	42	260	110	2	013800312
1500	45	260	120	2	013800315

1381

sledge hammers, Hickory shafts



g	A mm	L mm	L1 mm		
3000	55	800	142	1	013810030
4000	60	900	152	1	013810040
5000	70	900	162	1	013810050
8000*	80	900	185	1	013810080

* = ash shaft

1381/MR...

spare shafts for item 1381



1381MR 3-4 1381/3000-4000	2	013810730
1381MR 5 1381/5000	2	013810750
1381MR 8 1381/8000	2	013810780

1381T

sledge hammers, fibre shafts



g	A mm	L mm	L1 mm		
3000	55	900	142	1	013810330
4000	60	900	152	1	013810340
5000	70	900	162	1	013810350

1385

copper head hammers, wooden shafts



g	A mm	L mm	L1 mm		
400	26	260	75	2	013850404
600	32	270	80	2	013850406
800	34	280	90	2	013850408
1000	37	280	100	2	013850410
1500	43	280	110	2	013850415
2000	48	300	120	1	013850420

1385/MR

spare shafts for item 1385



1385MR 400	2	013850464
1385 400		
1385MR 600	2	013850466
1385 600		
1385MR 800	2	013850468
1385 800		
1385MR 1000	2	013850470
1385 1000		
1385MR 1500	1	013850475
1385 1500		
1385MR 2000	1	013850480
1385 2000		

1390

soft face hammers, wooden shafts



UNI 7784

D mm	L mm	L1 mm		
22	260	70	5	013900022
28	280	85	5	013900028
35	310	95	5	013900035
45	320	107	4	013900045
60	380	128	2	013900060

1390/MR...

spare shafts for item 1390



1390MR 22	2	013900222
1390/22		
1390MR 28	2	013900228
1390/28		
1390MR 35	2	013900235
1390/35		
1390MR 45	2	013900245
1390/45		
1390MR 60	2	013900260
1390/60		

1390R

spare faces for item 1390



D mm		
22	4	013900122
28	4	013900128
35	4	013900135
45	4	013900145
60	4	013900160

1390N

nylon face hammers, wooden shafts

Medium-hard faces: 75 Shore
Oil and wear resistant
Particularly suitable for working metal



D mm	L mm	L1 mm		
22	260	70	3	013900522
28	280	85	3	013900528
35	310	95	3	013900535
45	320	107	2	013900545
60	380	128	2	013900560

1390NR

spare nylon faces for item 1390N



D mm		
22	4	013900622
28	4	013900628
35	4	013900635
45	4	013900645
60	4	013900660



1391

dead-blow hammers, entirely covered with rubber



D mm	L mm	L1 mm		
35	280	90	2	013910135
50	320	105	2	013910150
55	355	110	2	013910155
65	380	130	2	013910165

1391A

dead-blow hammers for tile workers, entirely covered with rubber



g	D mm	L mm	L1 mm		
500	45	290	100	2	013910205
1000	60	300	120	2	013910210

1392

dead-blow hammers, with interchangeable plastic faces, steel shafts



D mm	L mm	L1 mm		
30	300	105	2	013920030
35	305	115	2	013920035
40	310	125	2	013920040
50	325	135	2	013920050
60	385	155	2	013920060

1392R

spare faces for item 1392



D mm		
30	4	013920230
35	4	013920235
40	4	013920240
50	4	013920250
60	4	013920260

1393

hard rubber head hammers



D mm	L mm	L1 mm	
50	315	90	3 013930050
60	340	110	3 013930060
70	370	130	2 013930070

1410/M

spring pulling hook wrench



∅ mm	
3,5	2 014100051

1428

pullers for damaged nuts with square drive



∅ mm	□	L mm	
8	3/8	36	2 014280008
10	3/8	36	2 014280010
11	3/8	36	2 014280011
12	3/8	36	2 014280012
13	3/8	36	2 014280013
14	3/8	36	2 014280014
15	1/2	38	2 014280015
16	1/2	38	2 014280016
17	1/2	38	2 014280017
18	1/2	38	2 014280018
19	1/2	38	2 014280019
20	1/2	38	2 014280020
21	1/2	38	2 014280021
22	1/2	38	2 014280022
24	1/2	38	2 014280024
27	1/2	38	2 014280027



1428/SB11 8-10-11-12-13-14 15-16-17-18-19 mm	1 014280111
1428/SB5 20-21-22-24-27 mm	1 014280115

1429

pullers for damaged screws and stud bolts with square drive



mm	□	L mm	
2	3/8	60	3 014290002
3	3/8	60	3 014290003
4	3/8	60	3 014290004
5	3/8	60	2 014290005
6	3/8	60	2 014290006
8	1/2	70	2 014290008
10	1/2	70	2 014290010



1429/SB7 2-3-4-5-6-8-10 mm	1 014290107
--------------------------------------	-------------

1430/...

tapered extractors for broken screws and studs made from hardened and tempered steel

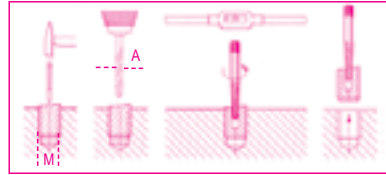

	M	A mm	
1430/1	3÷6	2,5	10 014300006
1430/2	6÷8	3,0	10 014300008
1430/3	8÷11	4,5	10 014300011
1430/4	11÷14	6,0	10 014300014
1430/5	14÷18	8,0	10 014300018
1430/6	18÷24	11,0	5 014300024
1430/7	24÷33	14,0	5 014300033
1430/8	33÷50	21,0	5 014300050



1430/S5 1430/1-1430/2-1430/3 1430/4-1430/5	1 014300105
1430/S6 1430/1-1430/2-1430/3 1430/4-1430/5-1430/6	1 014300106
1430/S8 1430/1-1430/2-1430/3 1430/4-1430/5-1430/6 1430/7-1430/8	1 014300108

1433

roller stud extractors

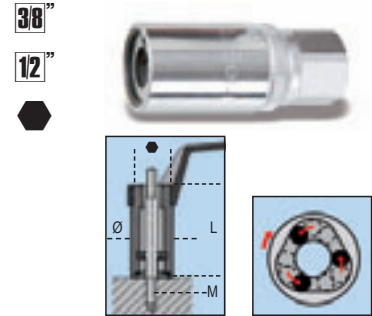

M mm	∅ mm	L mm	● mm	□	
5	21	60	19	3/8	2 014330005
6	24	60	21	1/2	2 014330006
7	24	60	21	1/2	2 014330007
8	24	60	21	1/2	2 014330008
9	28	70	21	1/2	2 014330009
10	28	70	21	1/2	2 014330010
10,5	28	70	21	1/2	2 014330021
11	28	70	21	1/2	2 014330011
12	28	70	21	1/2	2 014330012
14	36	72	24	-	2 014330014
16	36	72	24	-	2 014330016

1433/C11

roller stud extractors with 1/2" female square drives



1433/C11 M5 - M6 - M7 - M8 - M9 - M10 - M10,5 M11 - M12 - M14 - M16	1 014330311
∅ 340x135x56 mm - 3,0 kg	

1435

eccentric stud extractor



∅ mm	
4=20	1 014350001

1435R

spare wheel for item 1435



1435R	1 014350010
--------------	-------------

1435/1

eccentric stud extractor



∅ mm		
19±26	1	014350002

1435/1R

spare wheel for item 1435/1



1435/1R	1	014350011
---------	---	-----------

1500/...

two-leg universal pullers

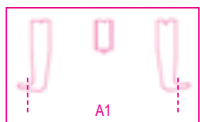
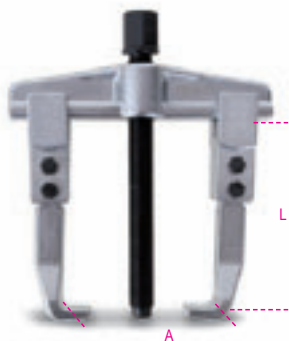

L mm		
1500/1	100	1 015000301
1500/2	100	1 015000302
1500/3	150	1 015000303
1500/4	150	1 015000304
1500/5	205	1 015000305
1500/6	205	1 015000306
1500/7	205	1 015000307
1500/8	230	1 015000308

	A min+Max mm	A1 min+Max mm
1500/1	25÷80	70÷130
1500/2	25÷130	80÷180
1500/3	50÷160	105÷220
1500/4	60÷200	120÷270
1500/5	80÷250	160÷330
1500/6	80÷350	160÷420
1500/7	110÷520	195÷600
1500/8	170÷640	260÷715



1500/SP5	1	015000325
1500/1-1500/2-1500/3		
1500/4-1500/5		
1500/SPV	1	015000001

1500G/...

legs, pair, standard series, for items 1500 and 1580/8I



	mm	1500		
1500G/1	35	/1-2	1	015000311
1500G/3	35	/3-4	1	015000313
1500G/5	35	/5-6-7	1	015000315
1500G/8	50	/8	1	015000317
		1580/8I		

1500N/...

universal pullers with 2 sliding legs

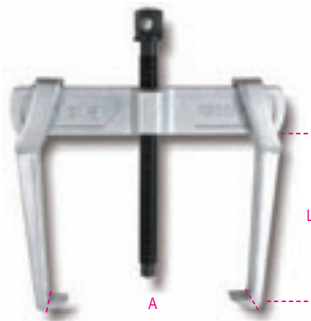

	A min+Max mm	L mm		
1500N/0	18÷65	70	1	015000600
1500N/1	23÷70	100	1	015000601
1500N/2	23÷100	100	1	015000602
1500N/3	35÷140	150	1	015000603
1500N/4	35÷190	150	1	015000604
1500N/5	43÷250	205	1	015000605
1500N/6	43÷320	205	1	015000606



1500N/SP6	1	015000626
1500N/0-1500N/1-1500N/2-1500N/3		
1500N/4-1500N/5		
1500N/SPV	1	015000006

1500N/G...

loose legs for pullers 1500N



	mm	1500N		
1500N/G0	10	/0	2	015000650
1500N/G1-2	12	/1-2	2	015000651
1500N/G3-4	17	/3-4	2	015000653
1500N/G5-6	23	/5-6	2	015000655

1501/1 - 2 - 3

thin leg pullers

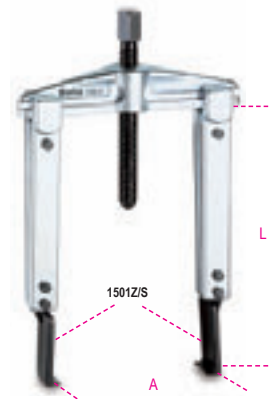

L mm		
1501/1	100	1 015010101
1501/2	200	1 015010102
1501/3	250	1 015010103

	A min+Max mm
1501/1	25÷130
1501/2	25÷130
1501/3	25÷130

1501G/1 - 2 - 3

legs for item 1501

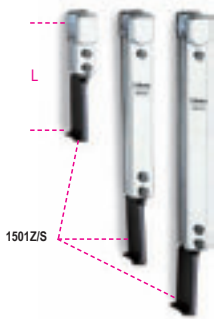

	L mm		
1501G/1	100	1	015010111
1501G/2	200	1	015010112
1501G/3	250	1	015010113

1501Z/S - P - R

leg ends for item 1501G



	$\frac{+5}{-0}$ mm	D mm		
1501Z/S	2.0	27	2	015010211
1501Z/P	3.6	27	2	015010212
1501Z/R	3.6	14	2	015010213

1506

two-leg self-locking puller

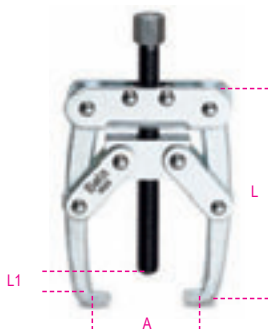

	A min+Max mm	L mm	L1 mm		
1506	10÷50	80	40	1	015060001

Beta

1508/1 - 1508/2

two-leg pullers, light series



	L mm		
1508/1	105	1	015080001
1508/2	130	1	015080002

	A min+Max mm	L1 mm
1508/1	6÷100	105
1508/2	10÷140	130

1511/1 - 2 - 3

external pullers
with two reversible legs

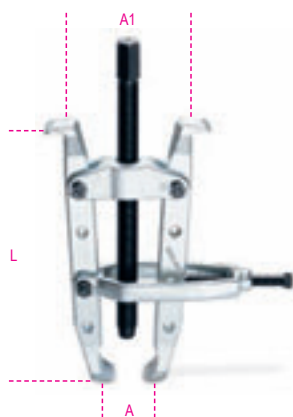

	L mm		
1511/1	235	1	015110001
1511/2	330	1	015110002
1511/3	405	1	015110003

	A min+Max mm	A1 min+Max mm
1511/1	20÷100	65÷95
1511/2	40÷150	103÷190
1511/3	40÷150	103÷175

1515/1 - 2 - 3

pullers with two floating legs

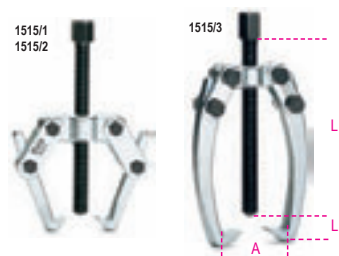

	L mm		
1515/1	85	1	015150101
1515/2	85	1	015150102
1515/3	105	1	015150103

	A Max mm	L1 mm
1515/1	60	105
1515/2	70	105
1515/3	90	105

1516/1 - 2 - 3

pullers with three floating legs



	L mm		
1516/1	85	1	015160001
1516/2	85	1	015160002
1516/3	105	1	015160003

	A Max mm	L1 mm
1516/1	60	85
1516/2	70	85
1516/3	90	105

1517

three-leg self-locking pullers

- For major pulling loads.
- Self-locking effect.



	L mm	L1 mm	Ø mm		
1517/90	182	60	22	1	015170000
1517/150	242	115	22	1	015170001
1517/200	307	150	22	1	015170002
1517/260	395	180	30	1	015170003

	● mm	A mm	kg	N
1517/90	19	18÷90	6000	59000
1517/150	19	25÷150	6000	59000
1517/200	19	40÷200	6000	59000
1517/260	27	50÷260	8000	78500

Beta

1518/...
three-leg pullers



	L mm		
1518/1	105	1	015180001
1518/2	135	1	015180002
1518/3	235	1	015180003
1518/4	270	1	015180004
1518/5	270	1	015180005
1518/6	270	1	015180006

	A min=Max mm	L1 mm
1518/1	24÷100	105
1518/2	32÷160	150
1518/3	40÷220	220
1518/4	80÷250	240
1518/5	80÷300	350
1518/6	80÷350	400

1520/1 - 1520/2
pullers with two reversible legs

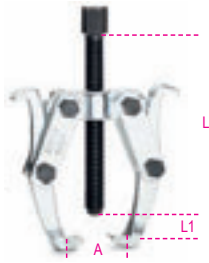

	L mm		
1520/1	135	1	015200101
1520/2	235	1	015200102

	A Max mm	L1 mm
1520/1	110	85
1520/2	160	140

1521/1 - 1521/2
pullers with three reversible legs

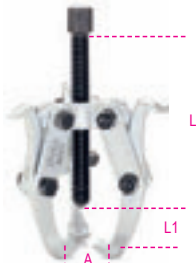

	L mm		
1521/1	135	1	015210101
1521/2	235	1	015210102

	A Max mm	L1 mm
1521/1	110	90
1521/2	160	140

1532
packing and oil seal removal tool



1532	2	015320001
------	---	-----------

1533/...
pullers for separators 1534

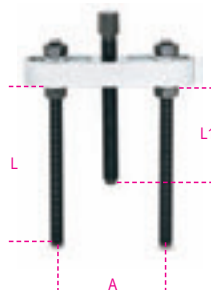

	L mm		
1533/2	150	1	015330002
1533/3	210	1	015330003
1533/4	315	1	015330004
1533/5	305	1	015330005

	A min=Max mm	L1 mm
1533/2	45÷130	110
1533/3	85÷225	175
1533/4	80÷285	175
1533/5	145÷370	235

1533PR/1 - 2 - 3
extensions for pullers 1533



1533PR/1	1	015330011
1533/2	1	015330012
1533PR/2	1	015330012
1533/3	1	015330013
1533PR/3	1	015330013
1533/4-5	1	015330013

1534/...
separators

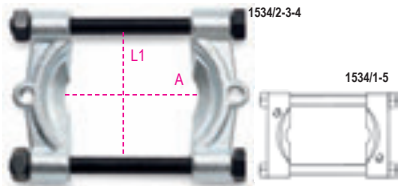

1534/1	1533/2	1	015340001
1534/2	1533/2	1	015340002
1534/3	1533/3	1	015340003
1534/4	1533/4	1	015340004
1534/5	1533/5	1	015340005

	A min=Max mm	L1 mm
1534/1	5÷60	88
1534/2	12÷75	118
1534/3	22÷115	160
1534/4	25÷155	205
1534/5	30÷220	290

1535/C...
puller kits



1535/C1	1	015350001
---------	---	-----------

1533/2	1533PR/1	1534/1
≡ 260x180x40 mm - 2,5 kg		

1535/C3	1	015350003
---------	---	-----------

1533/3	1533PR/2	1534/3
≡ 380x280x55 mm - 8,0 kg		

1535/C4	1	015350004
---------	---	-----------

1533/4	1533PR/3	1534/4
≡ 420x380x65 mm - 14,8 kg		

1535/C5	1	015350005
---------	---	-----------

1533/5	1533PR/3	1534/5
≡ 530x510x85 mm - 27,4 kg		

1539
sheet sliding hammer



1539	1	015390001
------	---	-----------

1540
sliding hammer



1540	390	M10	1544	0÷7	1	015400001
------	-----	-----	------	-----	---	-----------

1542/1 - 1542/2

two-leg pullers for extractors



	A	1544		
	min+Max			
	mm			
1542/1	35÷75	0÷7	1	015420001
1542/2	60÷130	9C-10C	1	015420002

	A	A1
	min+Max	mm
	mm	
1542/1	35÷75	105
1542/2	60÷130	160

1544/...

internal extractors

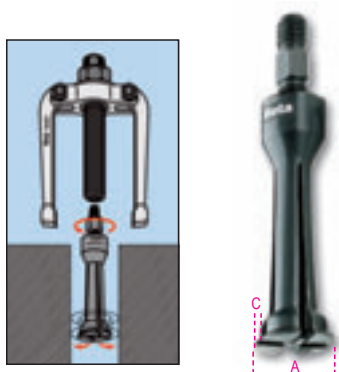

	C	mm	mm		
1544/0	0,25	M10	1	015440100	
A= 5÷7					
1544/A	0,80	M10	1	015440105	
A= 7÷9					
1544/1	0,80	M10	1	015440110	
A= 9÷12					
1544/2	1,15	M10	1	015440120	
A= 13÷17					
1544/2B	1,00	M10	1	015440121	
A= 14÷19					
1544/3	1,70	M10	1	015440130	
A= 16÷21					
1544/4	1,65	M10	1	015440140	
A= 20÷25					
1544/5	2,00	M10	1	015440150	
A= 25÷30					
1544/6	3,00	M10	1	015440160	
A= 30÷37					
1544/7	3,80	M10	1	015440170	
A= 38÷45					
1544/9C	2,60	G 3/8"	1	015440189	
A= 40÷75					
1544/10C	7,30	G 3/8"	1	015440199	
A= 70÷115					

1545/C5M

puller 1542/1 with 5 extractors 1544



1545/C5M 1 015450011

- 1542/1 ● 24 mm
- 1544/1 9÷12 mm
- 1544/2 13÷17 mm
- 1544/3 16÷21 mm
- 1544/4 20÷25 mm
- 1544/5 25÷30 mm

265x180x45 mm - 2,4 kg

1547/C6

dummy ball bearing extractors



1547/C6 1 015470006

420x185x60 mm - 3 kg

1547KP

set of 3 pairs of dummy ball terminals



	∅	mm		
1547KP/1	9-11-12,5	1	015470106	
1547KP/2	5-6-8	1	015470206	

1547P

hexagonal extensions



	L	mm		
1547P/1	205	1547/1	1	015470101
1547P/2	102	1547/2	1	015470201

1547PC/2

round extensions, short series



	L	mm		
1547PC/2	42	1547/2	1	015470202

1547PL/2

round extensions, long series



	L	mm		
1547PL/2	106	1547/2	1	015470203

1570/3

hydraulic presses for pullers



t	L	L1	mm		
30	243	36	19	1	015700003

1580/8I

two-leg hydraulic puller

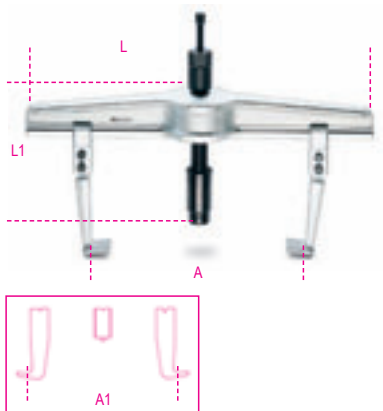

1580/8I 1 015800008

	A	L	L1	A1	N
	min+Max	mm	mm	min+Max	Max
	mm			mm	
1580/8I	170÷640	715	280	260÷715	180000



1580GL

loose legs, long series, for pullers item 1580/8l



	L mm		
1580GL/8A	300	1	015800227
1580GL/8B	400	1	015800228
1580GL/8C	500	1	015800229

1585/5l - 6l - 7l

three-leg pullers for hydraulic use

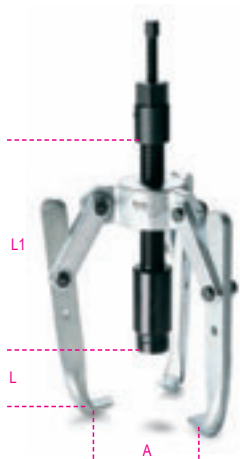

1585/5l		1	015850005
1585/6l		1	015850006
1585/7l		1	015850007

	A min+Max mm	L1 mm	L mm	N Max
1585/5l	50÷350	135	280	150000
1585/6l	50÷350	235	280	150000
1585/7l	50÷350	335	280	150000

1585GI/5 - 6 - 7

legs for hydraulic puller
1585/l-1585/6l-1585/7l

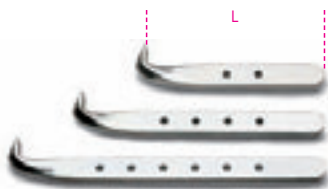

	L mm		
1585GI/5	135	1	015850205
1585GI/6	235	1	015850206
1585GI/7	335	1	015850207

1589VI

hydraulic screw for pullers
1580/8l and 1585/5l - 1585/6l - 1585/7l



1589VI		1	015890001
--------	--	---	-----------

1589PI/50 - 100 - 150

extension sockets for hydraulic screw



	L mm	L1 mm		
1589PI/50	50	70	1	015890005
1589PI/100	100	120	1	015890010
1589PI/150	150	170	1	015890015

1590

standard clamps



A max mm	L1 mm		
60	55	2	015900305
80	65	2	015900307
100	65	2	015900310
120	85	2	015900312
150	95	2	015900315

1591

screw clamps



A	A max mm	L1 mm		
200	200	80	2	015910020
300	310	85	2	015910030
400	410	85	2	015910040
500	500	95	2	015910050
600	600	95	2	015910060
800	800	95	2	015910080
1000	1000	110	2	015910100

1593

screw clamps

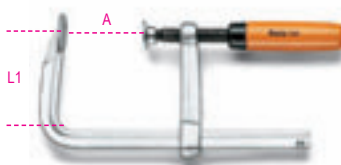

A	A max mm	L1 mm		
160	170	80	2	015930016
200	240	100	2	015930020
300	320	145	2	015930030

1594

lever bar clamps



A	A max mm	L1 mm		
200	240	145	1	015940020
250	290	145	1	015940025
300	340	145	1	015940030
400	430	150	1	015940040
500	530	150	1	015940050
600	630	150	1	015940060

1595

screw clamps

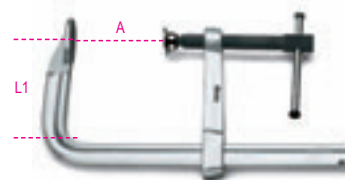

A	A max mm	L1 mm		
200	230	100	2	015950020
250	270	120	2	015950025
300	330	120	2	015950030
400	420	120	2	015950040
500	520	125	2	015950050
600	620	125	2	015950060
800	820	125	1	015950080
1000	1030	125	1	015950100

1599F

parallel bench vices

with hardened top and slides

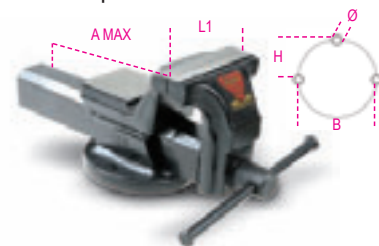

L1 mm	BxH mm	Ø mm	A MAX mm		
100	92x46	11	125	1	015990100
125	108x54	13	150	1	015990125
150	125x62	13	200	1	015990150
175	140x70	15	220	1	015990175

 **Beta**

1599P

parallel bench vices

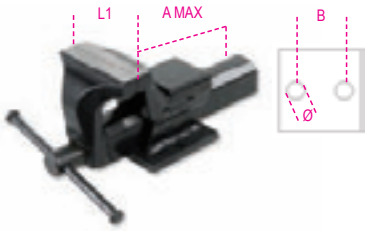

L1	B	Ø	A MAX		
mm	mm	mm	mm		
100	92	11	111	1	015990000
125	108	13	130	1	015990025
150	130	15	170	1	015990050

1599B

revolving bases for vices item 1599P



	1599P		
1599B 100	100	1	015990810
1599B 125	125	1	015990812
1599B 150	150	1	015990815

1599T

parallel drill vices

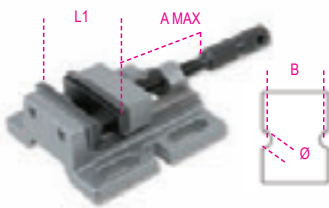

L1	B	Ø	A MAX		
mm	mm	mm	mm		
80	111	11	65	1	015990480
100	120	13	87	1	015990500

1599G

pairs of aluminium jaw covers



A		
mm		
100	1	015990910
125	1	015990912
150	1	015990915
180	1	015990917

1601/PC

ratchet crimping pliers for telephone terminals and data transmission

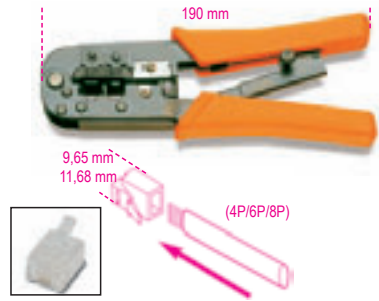

RJ11-RJ12-RJ45 2 016010011

1602

crimping pliers for insulated terminals, light series

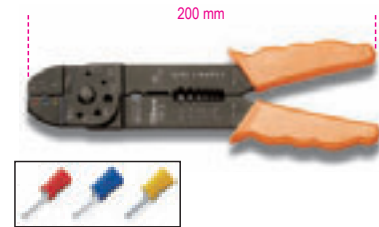

mm² 0,75÷6 5 016020001

1602/C9T

crimping pliers with assortment of 450 terminals



1602/C9T 1 016020013

		n.
1602		1
1620	R/6,3	50
1620	B/6,3	50
1620	G/6,3	50
1624	R/6,3	50
1624	B/6,3	50
1624	G/6,3	50
1628	R/1,6	50
1628	B/2,3	50
1628	G/3,6	50

420x350x35 mm - 1,5 kg

1602A

crimping pliers for insulated terminals, standard model

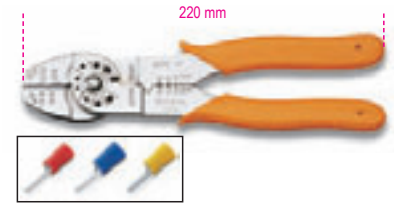

mm² 0÷6 2 016020005

1603

crimping pliers for non-insulated terminals, light series

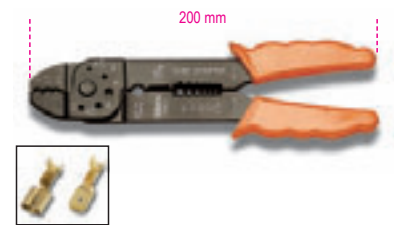

mm² 1,25÷5,5 5 016030001

1603A

crimping pliers for non-insulated closed terminals, standard model

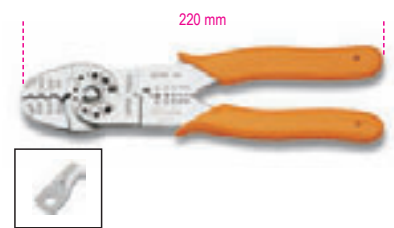

mm² 0÷8 2 016030005

1603B

crimping pliers for non-insulated open terminals, standard model

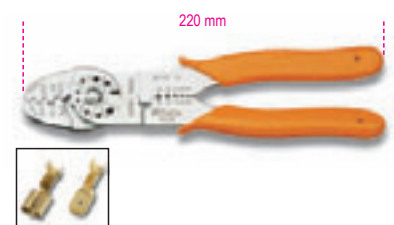

mm² 0÷8 2 016030010

1604

self-locking pliers
for insulated terminals



	mm ²			
	0,5÷6		1	016040001

1604/C9T

self-locking pliers 1604
with assortment of 450 terminals



1604/C9T			
	1		016040013

		n.
1604		1
1620	R/6,3	50
1620	B/6,3	50
1620	G/6,3	50
1624	R/6,3	50
1624	B/6,3	50
1624	G/6,3	50
1628	R/1,6	50
1628	B/2,3	50
1628	G/3,6	50

420x350x35 mm - 2 kg

1605

self-adjusting pliers
for non-insulated terminals

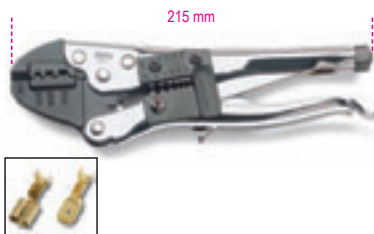

	mm ²			
	0,5÷6		1	016050001

1606

heavy duty crimping pliers
for cylindrical terminals



	mm ²			
	0,5÷6		1	016060001

1606A

crimping pliers for tubular terminals



		mm ²			
1606A6		0,5÷6		1	016060010
1606A16		6÷16		1	016060016

1606A/C9

crimping pliers for tubular terminals
with assortment of 450 terminals, 0,5÷6 mm²



1606A/C9			
	1		016060100

		n.
1606A		1
1632	W/0,5K	50
1632	N/1,5K	100
1632	B/2,5K	100
1632	G/4K	100
1632	Y/6K	100

420x350x35 mm - 2,5 kg

1607

heavy duty crimping pliers
for BNC coaxial wires RG 58, RG 59,
RG 62, RG 71

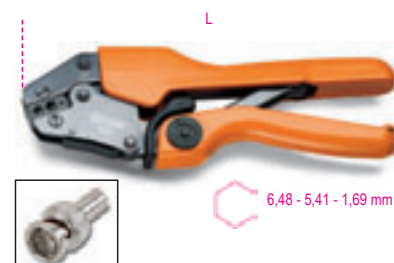

	L	A	B			
	mm	mm	mm		1	016070001
1607	220	73	19			

1608

crimping pliers for insulated terminals,
with pressure regulator

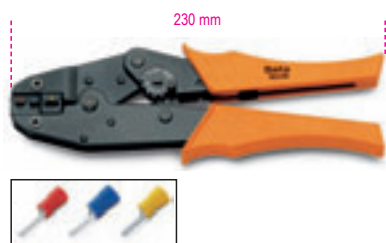

	mm ²			
	0,5÷6		1	016080001

1608/C9T

pliers 1608
with assortment of 450 terminals



1608/C9T			
	1		016080013

		n.
1608		1
1620	R/6,3	50
1620	B/6,3	50
1620	G/6,3	50
1624	R/6,3	50
1624	B/6,3	50
1624	G/6,3	50
1628	R/1,6	50
1628	B/2,3	50
1628	G/3,6	50

420x350x35 mm - 2 kg

1608A

heavy duty crimping pliers
for insulated terminals



mm²
0,75÷6

1 016080005

1609

crimping pliers for non-insulated
terminals, professional model
fast performance



mm²
0,5÷2,5

1 016090001

1609A

heavy duty crimping pliers
for non-insulated terminals



mm²
0,5÷6

1 016090005

1609B

crimping pliers for noninsulated terminals

punch crimps,
10 mm² ÷ 120 mm²



L
mm 600

mm²
10÷120

1 016090101

1609C/C5

oil-pressure crimping pliers
with 5 pairs of dies

hexagonal crimps,
25 mm² ÷ 240 mm²



mm²
50÷240

1 016090210

500x300x110 mm - 4 kg

1609M

dies for item 1609C

hexagonal crimps



	mm ²	
1609M/16	10-16	1 016090221
1609M/35	25-35	1 016090223
1609M/70	50-70	1 016090225
1609M/120	95-120	1 016090227
1609M/150	150	1 016090229
1609M/185	185	1 016090231
1609M/240	240	1 016090233

1610

ring terminals

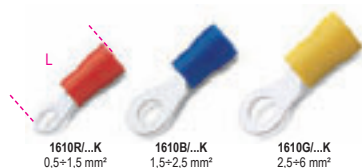

1610R...K 0,5÷1,5 mm²

1610B...K 1,5÷2,5 mm²

1610G...K 2,5÷6 mm²

1602; 1602A; 1604; 1608; 1608A

	D mm	L mm	
1610R/4K	4	0,5-1,5	17 1 016100104
1610R/5K	5	0,5-1,5	20 1 016100105
1610B/5K	5	1,5-2,5	22 1 016100115
1610B/6K	6	1,5-2,5	27 1 016100116
1610B/8K	8	1,5-2,5	27 1 016100118
1610G/6K	6	2,5-6	31 1 016100126
1610G/8K	8	2,5-6	34 1 016100128

The prices shown are for 100 pieces

1614

pin terminals

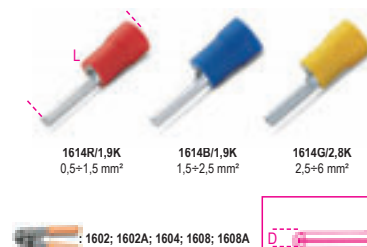

1614R/1,9K

0,5÷1,5 mm²

1614B/1,9K

1,5÷2,5 mm²

1614G/2,8K

2,5÷6 mm²

1602; 1602A; 1604; 1608; 1608A

	D mm	L mm	
1614R/1,9K	1,9	0,5-1,5	21 1 016140101
1614B/1,9K	1,9	1,5-2,5	21 1 016140102
1614G/2,8K	2,8	2,5-6	25 1 016140103

The prices shown are for 100 pieces

1616

male connectors

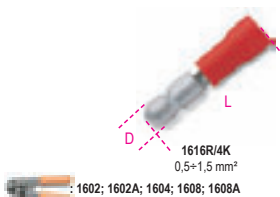

1616R/4K

0,5÷1,5 mm²

1602; 1602A; 1604; 1608; 1608A

	D mm	L mm	
1616R/4K	4	0,5-1,5	21 1 016160104

The prices shown are for 100 pieces

1618

female connectors



1618R/4K

0,5÷1,5 mm²

1602; 1602A; 1604; 1608; 1608A

	D mm	L mm	
1618R/4K	4	0,5-1,5	24 1 016180104

The prices shown are for 100 pieces

1620

male spade terminals

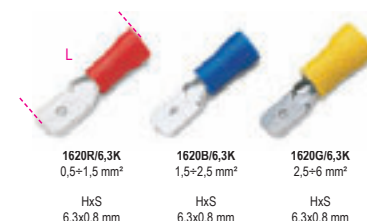

1620R/6,3K

0,5÷1,5 mm²

1620B/6,3K

1,5÷2,5 mm²

1620G/6,3K

2,5÷6 mm²

HxS
6,3x0,8 mm

HxS
6,3x0,8 mm

HxS
6,3x0,8 mm

1602; 1602A; 1604; 1608; 1608A

	D mm	L mm	
1620R/6,3K	0,5-1,5	22	1 016200101
1620B/6,3K	1,5-2,5	22	1 016200102
1620G/6,3K	2,5-6	22	1 016200103

The prices shown are for 100 pieces

1622

female spade terminals



1622R/2,8K
0,5+1,5 mm²
HxS
2,8x0,5 mm

1622B/6,3K
1,5+2,5 mm²
HxS
6,3x0,8 mm

1622G/6,3K
2,5+6 mm²
HxS
6,3x0,8 mm

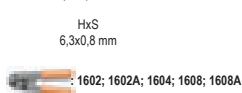

	L mm ²	L mm		
1622R/2,8K	0,5-1,5	20	1	016220101
1622R/6,3K	0,5-1,5	22	1	016220103
1622B/6,3K	1,5-2,5	22	1	016220106
1622G/6,3K	2,5-6	22	1	016220108

The prices shown are for 100 pieces

1624

insulated female terminals



1624R/6,3K
0,5+1,5 mm²
HxS
6,3x0,8 mm

1624B/6,3K
1,5+2,5 mm²
HxS
6,3x0,8 mm

1624G/6,3K
2,5+6 mm²
HxS
6,3x0,8 mm

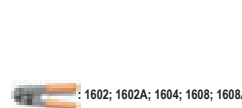

	L mm ²	L mm		
1624R/6,3K	0,5-1,5	23	1	016240102
1624B/6,3K	1,5-2,5	24	1	016240104
1624G/6,3K	2,5-6	24	1	016240105

The prices shown are for 100 pieces

1628

cable connectors



1628R/1,6K
0,5+1,5 mm²

1628B/2,3K
1,5+2,5 mm²

1628G/3,6K
2,5+6 mm²



	D mm	L mm ²	L mm		
1628R/1,6K	1,6	0,5-1,5	25	1	016280101
1628B/2,3K	2,3	1,5-2,5	26	1	016280102
1628G/3,6K	3,6	2,5-6	26	1	016280103

The prices shown are for 100 pieces

1630

rapid connectors



1630R/K
0,5+1,5 mm²

1630B/K
1,5+2,5 mm²

	L mm ²	L mm		
1630R/K	0,5-1,5	20	1	016300101
1630B/K	1,5-2,5	20	1	016300102

The prices shown are for 100 pieces

1632

tube terminals



1606; 1606A

	L mm ²	L mm		
1632W/0,5K	0,5	14	1	016320005
1632G/0,75K	0,75	14	1	016320007
1632R/1K	1	14	1	016320010
1632N/1,5K	1,5	15	1	016320015
1632B/2,5K	2,5	15	1	016320025
1632G/4K	4	17	1	016320040
1632Y/6K	6	20	1	016320060

The prices shown are for 100 pieces

1634

dual tube terminals



1606; 1606A

	L mm ²	L mm		
1634W/0,5K	0,5	15	1	016340005
1634G/0,75K	0,75	15	1	016340007
1634R/1K	1	15	1	016340010
1634N/1,5K	1,5	16	1	016340015
1634B/2,5K	2,5	19	1	016340025
1634G/4K	4	23	1	016340040
1634Y/6K	6	26	1	016340060

The prices shown are for 100 pieces

1639NS-N

friction tape, black



L m			
25	10	016390025	

1639S

nylon wire puller

with interchangeable heads



L m	∅ mm		
10	4	1	016390010

1640K

oil-pressure punching machine with 4 punches

round punches
22.5-25.5-32.5-55.5 mm



1640K		
	1	016400001

470x400x100 mm

1640

sheet metal punch press



1640		
	1	016400100

1640A

adapter for item 1640



1640A		
	1	016400080

1640P

threaded pin for item 1640



	Ø mm		
1640P/9	9,5	1	016400088
1640P/19	19	1	016400089

1640Q

square punches for item 1640



	mm		
1640Q 45	45x45	1	016400065

1640T

round punches for item 1640

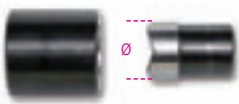

	Ø mm		
1640T 22,5	22,5	1	016400022
1640T 25,5	25,5	1	016400025
1640T 32,5	32,5	1	016400032
1640T 55,5	55,5	1	016400055

1650

sliding gauge
reading to 0.05 mm



UNI EN ISO 13385-1DIN 862

A max mm	L mm		
150	235	1	016500001
200	290	1	016500002

1650FD

sliding gauge for brake discs
reading to 0.1 mm

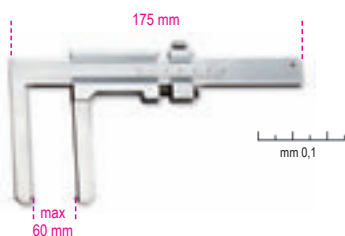

1650FD		1	016500050
--------	--	---	-----------

1650FT

sliding gauge for brake drums
made from stainless steel
reading to 0.05 mm



	A max mm	L mm		
1650FT/1	350	438	1	016500060
1650FT/2	500	550	1	016500070

1651DGT

digital vernier
reading to 0.01 mm

- Reading to 0.01 mm
- Screw slider locking
- Mm/inch conversion

CE



UNI EN ISO 13385-1DIN 862CE

A Max mm	L mm		
150	225	1	016510111
200	285	1	016510112

1651DGT/IP

digital vernier,
reading to 0.01 mm, degree of protection IP67

Total protection against dust and liquids; it also works when it is completely immersed.

CE



UNI EN ISO 13385-1 DIN 862CE

1651DGT/IP		1	016510611
------------	--	---	-----------

270x115x35 mm - 450 g

1652

analogue vernier,
analogue reading to 0.02 mm



UNI EN ISO 13385-1DIN 862

1652		1	016520016
------	--	---	-----------

1654

workshop verniers,
reading to 0.02 mm



UNI EN ISO 13385-1DIN 862

A max mm	L mm		
200	330	1	016540020
300	410	1	016540030

1654DGT

digital vernier,
reading to 0.01 mm
reading to 0.0005"

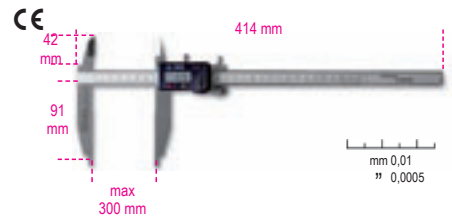

UNI EN ISO 13385-1DIN 862CE

1654DGT		1	016540111
---------	--	---	-----------

1656

depth gauge, reading to 0.02 mm

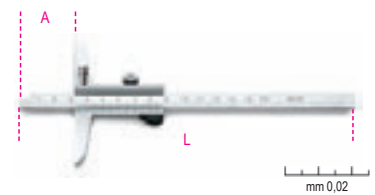

UNI EN ISO 13385-2DIN 862

A max mm	L mm		
200	260	1	016560020
300	360	1	016560030



1657DGT/2

digital depth gauge
reading to 0.01 mm
reading to 0,0005"

CE



UNI EN ISO 13385-2DIN 862CE

	A max mm	L mm	
1657DGT/2	200	270	1 016570002

1658/...

outside micrometers,
reading to 0.01 mm



DIN 863/II

	A mm	
1658/25	0÷25	1 016580025
1658/50	25÷50	1 016580050
1658/75	50÷75	1 016580075
1658/100	75÷100	1 016580100

1658/C4

assortment of 4 micrometers
item 1658



DIN 863

1658/C4		1 016580001
---------	--	-------------

1658/25	0÷25 mm
1658/50	25÷50 mm
1658/75	50÷75 mm
1658/100	75÷100 mm

365x245x35 mm - 2,5 kg

1658DGT

outside micrometers,
reading to 0.001 mm

CE



DIN 863CE

	A mm	
1658DGT25	0÷25	1 016580325
1658DGT50	25÷50	1 016580350

1658SP/1

base for micrometer



1658SP/1	1 016580910
----------	-------------

1659

thickness gauge with dial indicator,
reading to 0.01 mm.

C=dial field

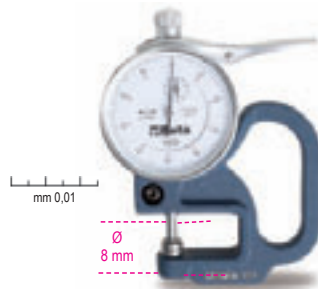

	C mm	
1659	0÷10	1 016590001

1662/1 - 1662/2

dial indicator, reading to 0.01 mm

C=dial field



DIN 878

	C mm	
1662/1	0÷5	1 016620001
1662/2	0÷10	1 016620010

1662DGT/A

digital dial indicator,
reading to 0.01 mm
C = Dial field



	C mm	
1662DGT/A	0-12,5	1 016620311

1662AN

adjustable stylus dial indicator,
reading to 0.01 mm

C=Dial field



DIN 2270

	C mm	
1662AN	0÷0,8	1 016620200

1662SP0

magnetic base



1662SP0	1 016620800
---------	-------------



1662SP2

magnetic base, rotating



1662SP2 1 016620910

1666

precision squares
made from stainless steel ground
and lapped



DIN 875/0

L mm	L1 mm	
100	70	1 016660210
150	100	1 016660215
200	130	1 016660220
250	165	1 016660225
300	200	1 016660230

1666A

flanged precision squares
made from stainless steel ground
and lapped



DIN 875/0

L mm	L1 mm	
100	70	1 016660110
150	100	1 016660115
200	130	1 016660120
250	170	1 016660125
300	200	1 016660130

1668

squares
made from normalized,
ground steel



DIN 875/2

L mm	L1 mm	
100	70	2 016680210
150	100	2 016680215
200	130	2 016680220
250	165	1 016680225
300	174	1 016680230

1668A

flanged precision squares
made from normalised, ground steel



DIN 875/2

L mm	L1 mm	
100	70	2 016680110
150	100	2 016680115
200	130	2 016680120
250	165	1 016680125
300	176	1 016680130

1670

squares
made from ground steel



L mm	L1 mm	
100	70	3 016700010
150	100	3 016700015
200	130	3 016700020
250	160	3 016700025
300	180	3 016700030
400	200	2 016700040
500	250	2 016700050
600	300	2 016700060
750	375	1 016700080
1000	500	1 016700099

1670A

flanged precision squares
made from ground steel



L mm	L1 mm	
100	70	3 016700110
150	100	3 016700115
200	130	3 016700120
250	160	3 016700125
300	180	3 016700130
400	200	2 016700140
500	250	2 016700150
600	300	2 016700160
800	400	1 016700180
1000	500	1 016700199

1672

mitre square, adjustable sliding blade,
base and blade made from steel

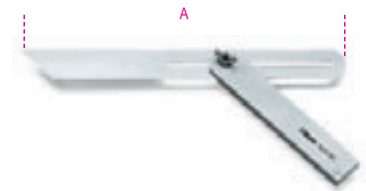

A
mm
300 2 016720030

1672A

mitre square, adjustable,
sliding blade, aluminium base,
blades made from chrome-plated steel

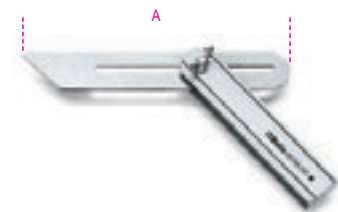

A
mm
200 3 016720120
300 3 016720130



1674A

carpenter's squares blades
made from stainless steel,
with aluminium bases, double metric scale



L mm	L1 mm		
300	169	2	016740130
400	214	2	016740140

1676

protractors made from stainless steel

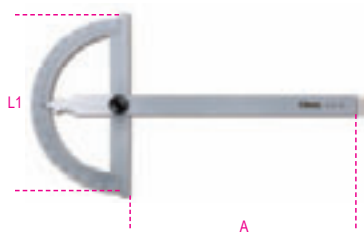

A °	A mm	L1 mm	G mm		
120	120	80	1°	2	016760012
150	165	120	1°	2	016760015
200	210	150	1°	2	016760020
300	310	200	1°	1	016760030

1678/C3

bevel protractor
made from stainless steel

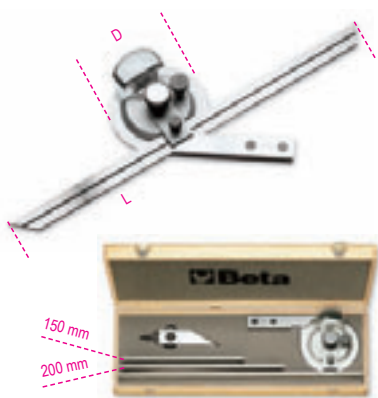

	L Max mm	D mm		
1678/C3	300	70	1	016780030

Beta

1679

universal gauge with contact-roll,
made from stainless steel,
reading to 0.1 mm

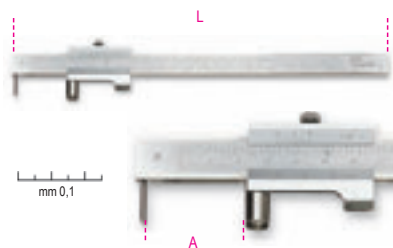

L mm	A Max mm		
235	200	1	016790020

1679/PR

spare tip for universal gauge 1679



1679/PR	1	016790021
---------	---	-----------

1680

trammels, hardened steel body
and tips

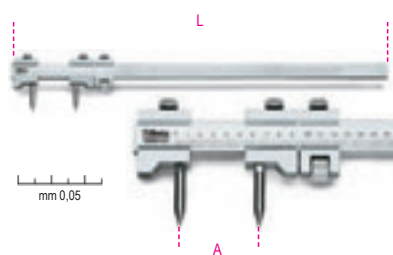

L mm	A Max mm		
660	500	1	016800050

1680A

inside callipers



L mm	A Max mm		
150	144	2	016800115
200	200	2	016800120
250	245	1	016800125
300	300	1	016800130

1680B

outside callipers



L mm	A Max mm		
150	155	2	016800215
200	190	2	016800220
250	235	1	016800225
300	280	1	016800230

1680C

precision dividers,
hardened steel straight tips



L mm	A Max mm		
150	138	2	016800315
200	190	2	016800320
250	235	1	016800325
300	280	1	016800330

1682

flexible graduated rules
made from stainless steel



L mm	H mm	$\pm s$ mm		
150	13	0,5	5	016820015
200	13	0,5	5	016820020
250	13	0,5	5	016820025
300	13	0,5	5	016820030
500	13	0,5	2	016820050
1000	13	0,5	2	016820100

1683

semi-rigid graduated rules
made from stainless steel

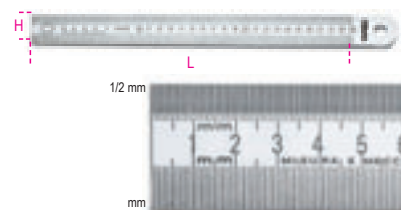

L mm	H mm	$\pm s$ mm		
300	30	1	5	016830030
500	30	1	2	016830050
1000	30	1	2	016830100
1500	30	1	1	016830150

Beta

1685/C7

assortment of 7 measuring and marking tools



1685/C7 1 016850110

	1650	160 mm
	1658/25	0+25 mm
	1670	100 mm
	1680C	150 mm
	1682	150 mm
	1688BC	165 mm
	1688BC/R	

320x210x37 mm - 1,2 kg

1687A

engineer's precision scribe, tip bent at 90°, with handle



1687A L mm 153 L1 mm 80 1 016870120

1687AC

engineer's precision scribe, short tip bent at 90°, with handle



1687AC L mm 153 L1 mm 80 1 016870125

1687D

engineer's precision scribe, straight tip, with handle



1687D L mm 153 L1 mm 80 1 016870110

1687U

engineer's precision scribe, hook tip, with handle

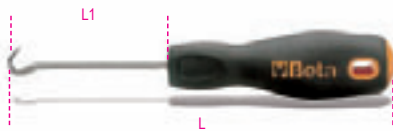

1687U L mm 153 L1 mm 80 1 016870115

1687/S4

set of 4 engineer's precision scribes, with handles



1687/S4 1 016870150
1687A-1687AC
1687D-1687U

1688

engineer's scribe made from hardened steel



1688 L mm 250 Ø mm 2 5 016880020

1688A

engineer's scribe made from hardened steel



1688A L mm 200 Ø mm 4 5 016880120

1688PC

engineer's scribe made of chrome-plated, hardened steel



1688PC L mm 150 Ø mm 1 1 016880300

1688PC/R

spare tip for item 1688PC



1688PC/R 1 016880310

1688M

carpenter's pencil



1688M L mm 180 50 016880880

1690F

folding ruler made of fibreglass precision class III



1690F/2 L m 2 S mm 17 5 016900220

1690L

folding ruler made of birch precision class III



1690L/2 L m 2 S mm 17 5 016900200

1691BM

measuring tapes shock-resistant bimaterial ABS casings, steel tapes, precision class: II

CE



1691BM/5 L m 5 S mm 25 1 016910205
1691BM/8 8 32 1 016910208
1691BM/10 10 32 1 016910210

1692

measuring tapes, shock-resistant bi-material ABS casings, steel tapes, precision class II

CE



1692/2 L m 2 S mm 16 5 016920052
1692/3 3 16 5 016920053
1692/5 5 19 5 016920055
1692/8 8 25 5 016920058

1694/L

measuring tapes shock-resistant
ABS casings, PVC-coated fibreglass tapes,
precision class III

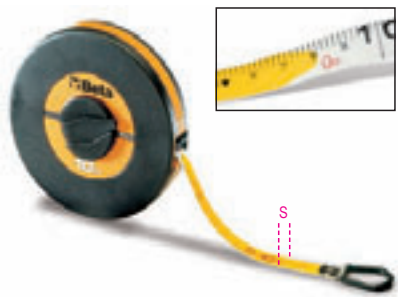

	L m	S mm		
1694L10	10	13	1	016940110
1694L20	20	13	1	016940120

1694A/L

measuring tapes with handles,
shock-resistant ABS casings,
PVC-coated fibreglass tapes,
precision class III



	L m	S mm		
1694A/L30	30	13	1	016940230
1694A/L50	50	13	1	016940250

1694B/L

measuring tape with handle,
aluminium casing, varnished steel tape,
precision class II



	L m	S mm		
1694B/L50	50	12,5	1	016940350

1695XS

pocket spirit level with magnetic V-shaped
base
made from profiled aluminium
2 unbreakable vials
accuracy: 1mm/m

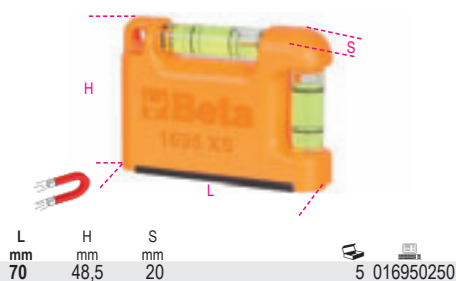

L mm	H mm	S mm		
70	48,5	20	5	016950250

1696

spirit levels made from anodized profile
aluminium, with 2 unbreakable vials,
accuracy: 1 mm/m



L mm	H mm	S mm		
200	50	19	2	016960002
400	50	19	2	016960004
500	50	19	2	016960005
600	50	19	2	016960006
800	50	19	2	016960008
1000	50	19	2	016960010

1696A

spirit levels made from die-cast
aluminium, with 1 ground base
and 2 unbreakable vials, accuracy: 1 mm/m

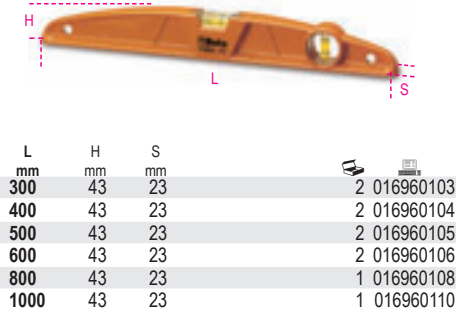

L mm	H mm	S mm		
300	43	23	2	016960103
400	43	23	2	016960104
500	43	23	2	016960105
600	43	23	2	016960106
800	43	23	1	016960108
1000	43	23	1	016960110

1696B

spirit levels with magnetic bases
made from anodized profiled aluminium,
2 unbreakable vials accuracy: 1 mm/m

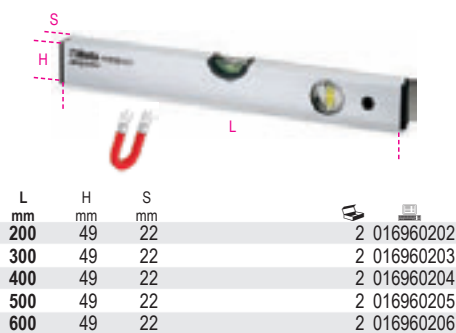

L mm	H mm	S mm		
200	49	22	2	016960202
300	49	22	2	016960203
400	49	22	2	016960204
500	49	22	2	016960205
600	49	22	2	016960206

1696D

spirit levels made of die-cast aluminium with
handles,
4 ground bases and 3 unbreakable vials,
accuracy: 1 mm/m



L mm	H mm	S mm		
300	47	25	2	016960353
400	47	25	2	016960354
500	47	25	2	016960355
600	47	25	2	016960356

1696S

levelling staffs made from aluminium, with 2
unbreakable vials

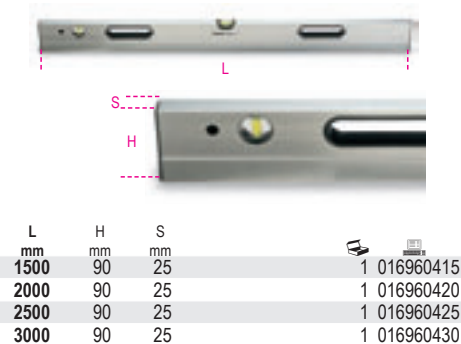

L mm	H mm	S mm		
1500	90	25	1	016960415
2000	90	25	1	016960420
2500	90	25	1	016960425
3000	90	25	1	016960430

1699L

precision surface level made from
die-cast iron with ground prismatic
base, 2 unbreakable vials,
accuracy: 0.05 mm/m

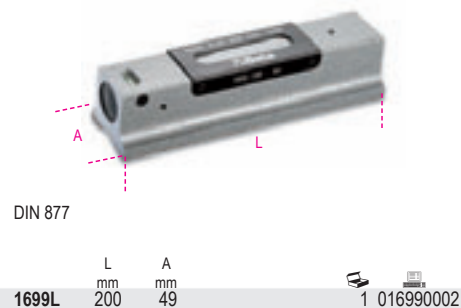

	L mm	A mm		
1699L	200	49	1	016990002

1699L/1

precision surface level made
from die-cast iron with ground prismatic
base, 2 unbreakable vials,
accuracy: 0.02 mm/m



	L mm	A mm		
1699L/1	200	49	1	016990005

1699Q

precision square levels made from die-cast iron with 2 prismatic bases and 2 ground flat bases, 2 unbreakable vials, accuracy: 0.05 mm/m



DIN 877

L mm	A mm		
150	40	1	016990015
200	48	1	016990020

1700N

masonry points



L mm	S mm		
250	16	5	017000005
300	16	5	017000006

1700N/PM

masonry points with hand guards



L mm	S mm		
250	16	2	017000105
300	16	2	017000106

1701N

masonry chisels



L mm	A mm	S mm		
250	23	16	5	017010001
300	23	16	5	017010003

1701N/PM

masonry chisels with hand guards



L mm	A mm	S mm		
250	23	16	2	017010101
300	23	16	2	017010103

1701PMR

hand guards for items 1700N and 1701N

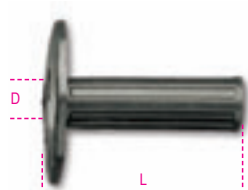

D mm	L mm		
16	115	1	017010206

1701NE/...

electrician's chisels



	SxL mm		
1701NE3	10x200	5	017010406
1701NE4	10x250	5	017010409

1702N

extra-wide chisels



A mm	SxH mm		
50	12x25	2	017020005
70	12x25	2	017020007

1702N/PM

extra-wide chisels with hand guards

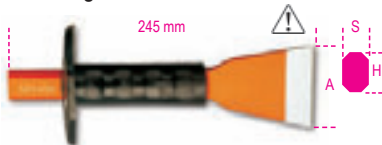

A mm	SxH mm		
50	12x25	2	017020105
70	12x25	2	017020107



We recommend frequent cooling of the tool while regrinding it.

1702PMR

hand guard for item 1702N



L mm			
115	1	017020200	

1704

carpenter's wrenching bars

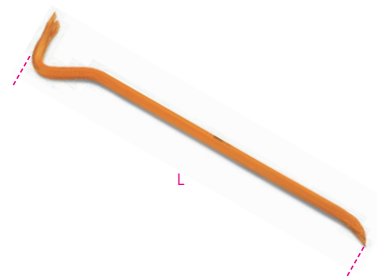

L mm					
500	16	35	28	2	017040050
600	16	34	26	2	017040060
800	18	38	29	2	017040080

1704A

crow bars with open and pointed edges

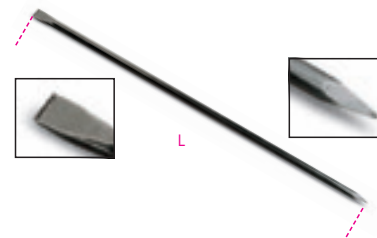

L mm					
1500	25	51		1	017040110
2000	28	55		1	017040120

1704C

crow bars with closed and pointed edges



L mm	B mm	min-MAX mm		
1200	21-31	39	1	017040210
1400	31-37	42	1	017040212
1600	25-37	42	1	017040215

1705

chalk line reel made from aluminium



L mm	L m		
1705	30	4	017050001

1705PT
chalk powder



g	250	5	017050025
---	-----	---	-----------

1706DGT
digital depth gauge for tyre threads



1706DGT	1	017060011
---------	---	-----------

1707
screw pitch gauge
For ISO 60° metric and Whitworth 55° threads



P (ISO)	W	5	017070001
0,25÷6	62÷4x1"		

1707A/1 - 2 - 3
radius gauges,
concave and convex steel blades



	R	L		
	mm	mm	n	
1707A/1	1,0÷7,0	70	34	2 017070007
1707A/2	7,5÷15	85	32	2 017070015
1707A/3	15,5÷25	85	30	2 017070025

1708/8 - 13 - 20
metric feeler gauges



1708/8	S = 0,05±0,50 mm	5	017080008
1708/13	S = 0,05±1,00 mm	5	017080013
1708/20	S = 0,05±1,00 mm	5	017080020

1709/10 - 1709/18
nut splitters



	L	A max		
	mm	mm		
1709/10	90	17 (M10)	1	017090010
1709/18	108	25 (M16)	1	017090018

1710
hydraulic nut splitters



	C min	C max		
	mm	mm		
1710	7(M4)	22(M14)	1	017100001

1712E/1 - 2 - 3
flexible magnetic pick up tools

F = magnetic power



	L	D	F	
	mm	mm	kg	
1712E/1	420	7,5	0,5	2 017120011
1712E/2	530	15	1,8	2 017120012
1712E/3	532	19	3,0	2 017120013

1712E/L1
flexible magnetic pick-up tool with LED light

F = magnetic force
Battery: 2xLR48

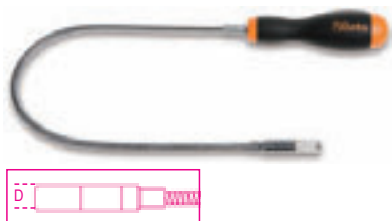

	L	D	F	
	mm	mm	kg	
1712E/L1	500	11	0,75	2 017120111

1712E/R-L1
spare heads for item 1712E/L1, with LED and magnet

1712E/R-L1	1	017120611
------------	---	-----------

1712TF
telescopic magnet with flexible head

• With washer jet cleaner
F = magnetic force



	L	D	F	
	mm	mm	kg	
1712TF	150÷590	11	1	1 017120600

1713M
flexible pickup tools

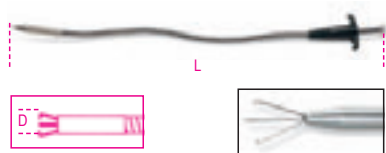

	L	D		
	mm	mm		
1713M	500	7	2	017130011
	1000	7	1	017130015

1714
inspection mirror made from plastic



	L	D		
	mm	mm		
1714	155	25	5	017140001

1715
telescopic joint inspection mirror
chrome-plated metal body



	L	D		
	mm	mm		
1715	180÷540	30	1	017150001

1715FL/A
square flexible inspection mirror



	L	A	B	
	mm	mm	mm	
1715FL/A	600	53	90	1 017150110

1715R/FL
kit of 2 inspection mirrors for items 1715FL/A and 1715FL/B

1715R/FL	1	017150151
----------	---	-----------

1715FL/B

rectangular flexible inspection mirror with light

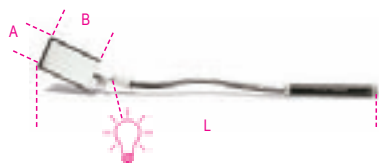

L	A	B			
mm	mm	mm			
1715FL/B	553	53	90	1	017150115

1715B/R5L

kit of 5 spare light bulbs for item 1715FL/B

1715B/R5L	5	017150152
-----------	---	-----------

1716A

angled bit for general use

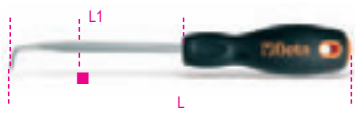

L	L1	■			
mm	mm	mm			
1716A	240	125	6	3	017160040

1716P

packing scraper



L	L1	●			
mm	mm	mm			
1716P	250	125	6	3	017160020

1716Q

square bit reamer

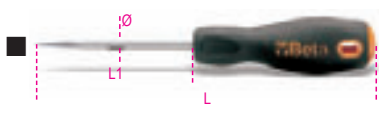

L	L1	Ø			
mm	mm	mm			
1716Q	215	100	6	5	017160010

1716R

round bit reamer

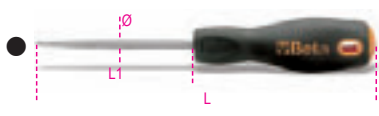

L	L1	Ø			
mm	mm	mm			
1716R	215	100	6	5	017160001

1716U

hook bit for general use



L	L1	Ø			
mm	mm	mm			
1716U	195	80	6	3	017160025

1717A

scrapers, two cutting edges



L	L1	L2			
mm	mm	mm			
1717A	150	70	260	2	017170015
	200	75	310	2	017170020
	250	100	360	2	017170025

1717B

scrapers, three cutting edges



L	L1	L2			
mm	mm	mm			
1717B	150	75	260	2	017170115
	200	85	310	2	017170120
	250	100	360	2	017170125

1717C

flat scrapers, varnished



L	S	L1			
mm	mm	mm			
1717C	150	18	270	2	017170215
	200	20	320	2	017170220
	250	25	370	2	017170225

1717D

flat scraper, front cut



L	S	L1				
mm	mm	mm				
1717D	150	150	23	240	2	017170320

1718D...Q

rough square files, without handles



	L	L"		
	mm	mm		
1718D6/Q	150	6	5	017180121
1718D8/Q	200	8	5	017180131
1718D10/Q	250	10	5	017180141

1718A...Q

second-cut square files, without handles



	L	L"		
	mm	mm		
1718A6/Q	150	6	5	017180021
1718A8/Q	200	8	5	017180031
1718A10/Q	250	10	5	017180041

1718D...T

rough triangular files, without handles



	L	L'		
	mm	mm		
1718D6/T	150	6	5	017180123
1718D8/T	200	8	5	017180133
1718D10/T	250	10	5	017180143

1718A...T

second-cut triangular files, without handles



	L	L"		
	mm	mm		
1718A6/T	150	6	5	017180023
1718A8/T	200	8	5	017180033
1718A10/T	250	10	5	017180043

1718D...P

rough flat files, without handles



	L	L'		
	mm	mm		
1718D6/P	150	6	5	017180125
1718D8/P	200	8	5	017180135
1718D10/P	250	10	5	017180145

1718A...P

second-cut flat files, without handles



	L	L'		
	mm	mm		
1718A6/P	150	6	5	017180025
1718A8/P	200	8	5	017180035
1718A10/P	250	10	5	017180045

1718D...M

rough half-round files, without handles



	L	L'		
	mm	mm		
1718D6/M	150	6	5	017180127
1718D8/M	200	8	5	017180137
1718D10/M	250	10	5	017180147

1718A...M

rough half-round files, without handles



	L	L'		
	mm	mm		
1718A6/M	150	6	5	017180027
1718A8/M	200	8	5	017180037
1718A10/M	250	10	5	017180047

1718D...R

rough round files, without handles



	L mm	L "		
1718D6/R	150	6	5	017180129
1718D8/R	200	8	5	017180139
1718D10/R	250	10	5	017180149

1718A...R

second-cut round files, without handles



	L mm	L "		
1718A6/R	150	6	5	017180029
1718A8/R	200	8	5	017180039
1718A10/R	250	10	5	017180049

1718D...S5

set of 5 rough files, without handles

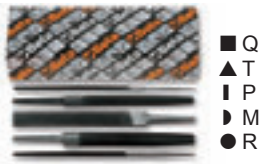

	L mm	L "		
1718D6/S5	150	6	1	017180130
1718D8/S5	200	8	1	017180140
1718D10/S5	250	10	1	017180150

1718A...S5

set of 5 second-cut files, without handles

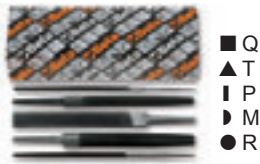

	L mm	L "		
1718A6/S5	150	6	1	017180030
1718A8/S5	200	8	1	017180040
1718A10/S5	250	10	1	017180050

1719BMD...Q

rough square files, with handles



	L mm	L "		
1719BMD6/Q	150	6	5	017190191
1719BMD8/Q	200	8	5	017190221
1719BMD10/Q	250	10	5	017190241
1719BMD12/Q	300	12	3	017190325

1719BMA...Q

second-cut square files, with handles



	L mm	L "		
1719BMA6/Q	150	6	5	017190021
1719BMA8/Q	200	8	5	017190052
1719BMA10/Q	250	10	5	017190071
1719BMA12/Q	300	12	3	017190311

1719BMX...Q

smooth square files, with handles



	L mm	L "		
1719BMX6/Q	150	6	5	017190022
1719BMX8/Q	200	8	5	017190053
1719BMX10/Q	250	10	5	017190072

1719BMD...T

rough triangular files, with handles



	L mm	L "		
1719BMD6/T	150	6	5	017190193
1719BMD8/T	200	8	5	017190223
1719BMD10/T	250	10	5	017190243
1719BMD12/T	300	12	3	017190326

1719BMA...T

second-cut triangular files, with handles



	L mm	L "		
1719BMA6/T	150	6	5	017190023
1719BMA8/T	200	8	5	017190054
1719BMA10/T	250	10	5	017190073
1719BMA12/T	300	12	3	017190313

1719BMX...T

smooth triangular files, with handles



	L mm	L "		
1719BMX6/T	150	6	5	017190024
1719BMX8/T	200	8	5	017190055
1719BMX10/T	250	10	5	017190074

1719BMD...P

rough flat files, with handles



	L mm	L "		
1719BMD6/P	150	6	5	017190195
1719BMD8/P	200	8	5	017190225
1719BMD10/P	250	10	5	017190245
1719BMD12/P	300	12	3	017190327

1719BMA...P

second-cut flat files, with handles



	L mm	L "		
1719BMA6/P	150	6	5	017190025
1719BMA8/P	200	8	5	017190056
1719BMA10/P	250	10	5	017190075
1719BMA12/P	300	12	3	017190315

1719BMX...P

smooth flat files, with handles



	L mm	L "		
1719BMX6/P	150	6	5	017190026
1719BMX8/P	200	8	5	017190057
1719BMX10/P	250	10	5	017190076

1719BMD...M

rough half-round files, with handles



	L mm	L "		
1719BMD6/M	150	6	5	017190197
1719BMD8/M	200	8	5	017190227
1719BMD10/M	250	10	5	017190247
1719BMD12/M	300	12	3	017190328

1719BMA...M

second-cut half-round files, with handles



	L mm	L "		
1719BMA6/M	150	6	5	017190027
1719BMA8/M	200	8	5	017190058
1719BMA10/M	250	10	5	017190077
1719BMA12/M	300	12	3	017190317

1719BMX...M

smooth half-round files, with handles



	L mm	L "		
1719BMX6/M	150	6	5	017190028
1719BMX8/M	200	8	5	017190059
1719BMX10/M	250	10	5	017190078

1719BMD...R

rough round files, with handles



	L mm	L "		
1719BMD6/R	150	6	5	017190199
1719BMD8/R	200	8	5	017190229
1719BMD10/R	250	10	5	017190249
1719BMD12/R	300	12	3	017190329

1719BMA...R

second-cut round files, with handles



	L mm	L "		
1719BMA6/R	150	6	5	017190029
1719BMA8/R	200	8	5	017190060
1719BMA10/R	250	10	5	017190079
1719BMA12/R	300	12	3	017190319

1719BMX...R

smooth round files, with handles



	L mm	L "		
1719BMX6/R	150	6	5	017190031
1719BMX8/R	200	8	5	017190061
1719BMX10/R	250	10	5	017190081

1719BMD...S5

set of 5 rough files, with handles



	L mm	L "		
1719BMD6/S5	150	6	1	017190200
1719BMD8/S5	200	8	1	017190230
1719BMD10/S5	250	10	1	017190250
1719BMD12/S5	300	12	1	017190363

1719BMA...S5

set of 5 second-cut files, with handles



	L mm	L "		
1719BMA6/S5	150	6	1	017190030
1719BMA8/S5	200	8	1	017190070
1719BMA10/S5	250	10	1	017190080
1719BMA12/S5	300	12	1	017190361

1719BMX...S5

set of 5 smooth files, with handles



	L mm	L "		
1719BMX6/S5	150	6	1	017190032
1719BMX8/S5	200	8	1	017190069
1719BMX10/S5	250	10	1	017190082

1719BMB/P

universal cut flat files, plastic handles

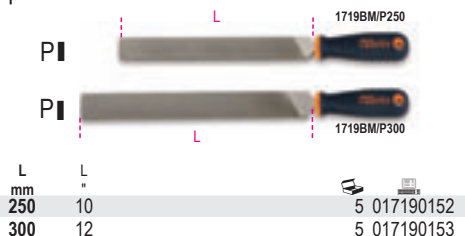

	L mm	L "		
250	250	10	5	017190152
300	300	12	5	017190153

1719BMC

half-round and flat files, plastic handles



UNI 5569 - UNI 5568

	L mm	L "		
1719BMC/M 250	250	10	6	017190252
1719BMC/M 300	300	12	4	017190253
1719BMC/P 250	250	10	6	017190262
1719BMC/P 300	300	12	4	017190263

1719BM/RR

round rasp, plastic handle

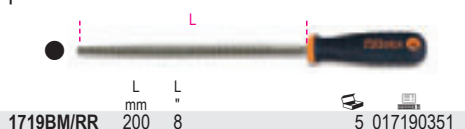

	L mm	L "		
1719BM/RR	200	8	5	017190351

1719BM/RL

flat rasp file, plastic handle

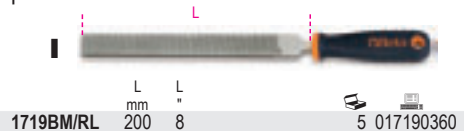

	L mm	L "		
1719BM/RL	200	8	5	017190360

1719BMR

handles for files

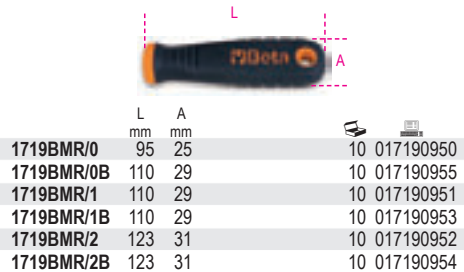

	L mm	A mm		
1719BMR/0	95	25	10	017190950
1719BMR/0B	110	29	10	017190955
1719BMR/1	110	29	10	017190951
1719BMR/1B	110	29	10	017190953
1719BMR/2	123	31	10	017190952
1719BMR/2B	123	31	10	017190954

	mm	-		
1719BMR/0	100/150	4/6	▲▶	
1719BMR/0B	100/150	4/6	■●	
1719BMR/1	150/200	6/8	▶▶	
1719BMR/1B	150/200	6/8	■●	
1719BMR/2	250/300	10/12	▶▶	
1719BMR/2B	250/300	10/12	■●	

1720/...

needle files



UNI 5569 UNI 5670

	L mm		
1720T	160	5	017200004
1720P	160	5	017200006
1720M	160	5	017200008
1720Q	160	5	017200009
1720R	160	5	017200010
1720C	160	5	017200012
1720B	160	5	017200005
1720ML	160	5	017200007
1720BT	160	5	017200011
1720F	160	5	017200013
1720PP	160	5	017200014
1720RM	160	5	017200015



1720/S3		1	017200000

1720/B

set of 6 needle files in plastic wallet



1720/B6	1	017200002
1720/B12	1	017200003

1720D/...

diamond needle files



	L mm		
1720D/T	160	2	017200104
1720D/P	160	2	017200106
1720D/M	160	2	017200108
1720D/Q	160	2	017200109
1720D/R	160	2	017200110
1720D/C	160	2	017200112



1720D/B6	1	017200120
----------	---	-----------

1721/B6

set of 6 files for ignition contacts in plastic wallet



1721/B6	1	017210010
---------	---	-----------

1723

spring puller



1723	L mm		
	210	5	017230001

1725

hacksaw frame



1725	L mm	L1 mm	
	420	300	4 017250001

1725CR

mini hacksaw frame



1725CR	L mm	L1 mm	
	250	150	5 017250010

1726

hacksaw frame, blade attachment system in the handle

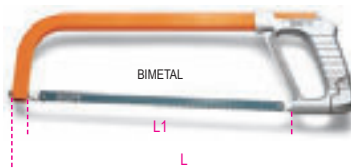

1726	L mm	L1 mm	
	440	300	4 017260001

1726BM

Hacksaw frame with quick release blade attachment system

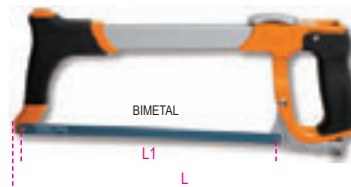

1726BM	L mm	L1 mm	
	400	300	1 017260050

1727

hacksaw frame, heavy series

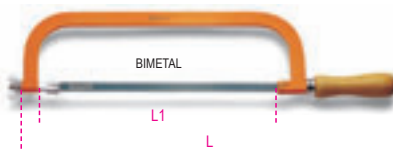

1727	L mm	L1 mm	
	515	300	4 017270001

1727BM

hacksaw frame, one hand grip



1727BM	L mm	L1 mm	
	315	300	5 017270020

1728...

blades for hacksaw frames

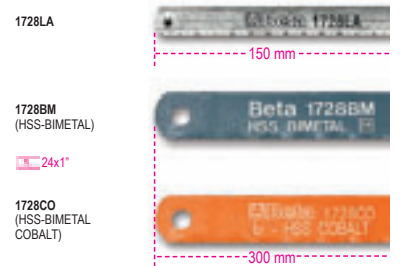

1728LA	100	017280001
1725CR		
1725MQ		
1728BM	100	017280010
1725-1726		
1727-1727M		
1728CO	50	017280030
1725-1726		
1727-1727M		

1729

fixed frame hacksaw

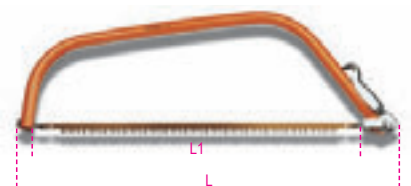

1729	L mm	L1 mm	
	710	610	5 017290001

1729LR

spare blade for item 1729



1729LR	10	017290010
--------	----	-----------

1729CG

plasterboard saw



1729CG	L mm	L1 mm	
	310	160	2 017290200

1729DM 450

wood rip saw

medium tothing, 12 teeth/inch



1729DM 450	L mm	L1 mm	
	450	400	4 017290450

1736A

file brush



1736A L mm 240 10 017360010

1737

brush, brass wires



1737 L mm 145 10 017370001

1737NX

brake shoe cleaning brush
plastic handle steel wires



1737NX L mm 270 5 017370010

1737AC

steel wire brush



1737AC L mm 275 5 017370020

1737B

pairs of battery lug and post cleaner steel brushes



1737B 1 017370050

1738

bristle brush



1738 L mm 210 H mm 30 10 017380001

1739B

lazy tongs riveter, supplied with 5 interchangeable nozzles



max 830 mm						
Ø mm	3,2	4	4,8	5	6	6,4
Aluminium	•	•	•	•	•	•
Stainless steel	•	•	•	•		

1739B 1 017390151

1740A

heavy duty riveting pliers supplied with 5 interchangeable nozzles



525 mm						
Ø mm	3,2	4	4,8	5	6	6,4
aluminium	•	•	•	•	•	•
stainless steel	•	•	•	•		

1740A 1 017400101

1740B

compact heavy-duty riveting pliers, supplied with 5 interchangeable nozzles



Ø mm	2,4	3	3,2	3,2	4,8
aluminium	•	•	•	•	•
stainless steel	•	•	•	•	•
Inox	•	•	•	•	•

1740B 280 L mm 280 1 017400280

Ø mm	3,2	4	4,8	5	6	6,4
aluminium	•	•	•	•	•	•
stainless steel	•	•	•	•	•	•
Inox	•	•	•	•	•	•

1740B 330 L mm 330 1 017400330

1741B

riveting pliers supplied with 4 interchangeable nozzles



250 mm					
Ø mm	2,4	3,2	4	4,8	5
Aluminium	•	•	•	•	•
Steel	•	•	•	•	•
Stainless steel	•	•	•		

1741B 1 017410000

1741B/C5

riveting pliers item 1741B with assortment of 700 aluminium rivets



1741B/C5 1 017410025

	Ø mm	L mm	n.
1741RV2,9K	3,0	6	200
1741RV3,2K	3,2	8	200
1741RV3,8K	4,0	10	100
1741RV4K	4,0	12	100
1741RV4,8K	4,8	12	100

415x155x60 mm - 3,1 Kg

1741BP

riveting pliers supplied with 4 interchangeable nozzles



260 mm					
Ø mm	2,4	3,2	4	4,8	5
Aluminium	•	•	•	•	•
Steel	•	•	•	•	•
Stainless steel	•	•	•	•	•

1741BP 1 017410350

1741U

ultra compact riveting pliers with adjustable force
with 4 interchangeable nozzles
3 legs: enhanced rivet hold



200 mm

Ø mm	2,4	3	3,2	4	4,8
Aluminium	•	•	•	•	•
Steel	•	•	•	•	•
Stainless steel	•	•	•	•	•

1741U 1 017410450

1741RV...K

aluminium rivets



1741RV 2,9K ØxL = 3x6 mm	1 017410191
1741RV 3,2K ØxL = 3,2x8 mm	1 017410192
1741RV 3,8K ØxL = 4x10 mm	1 017410193
1741RV 4K ØxL = 4x12 mm	1 017410194
1741RV 4,8K ØxL = 4,8x12 mm	1 017410195

The prices shown are for 500 pieces

1742

riveting pliers for threaded rivets,
with 4 interchangeable mandrels



250 mm

1742 1 017420001

M	Ø mm	L mm
3	5	11
4	6	11
5	7	13
6	9	17

1742KR

spare mandrels for item 1742



M3	1 017420043
M4	1 017420044
M5	1 017420045
M6	1 017420046

1742R-AL/M...

aluminium threaded rivets for items
1742-1742A-1946KF



1742R-AL M3 ØxL = 5x10 mm M = 3	1 017420023
1742R-AL M4 ØxL = 6x12 mm M = 4	1 017420024
1742R-AL M5 ØxL = 7x13 mm M = 5	1 017420025
1742R-AL M6 ØxL = 9x15 mm M = 6	1 017420026

The prices shown are for 20 pieces

1742R-A/M...

steel threaded rivets for items
1742-1742A-1946KF

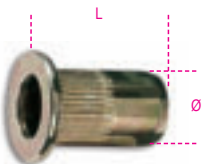

1742R-A M3 ØxL = 5x11 mm M = 3	1 017420013
1742R-A M4 ØxL = 6x11 mm M = 4	1 017420014
1742R-A M5 ØxL = 7x13 mm M = 5	1 017420015
1742R-A M6 ØxL = 9x17 mm M = 6	1 017420016
• 1742R-A M8 ØxL = 11x17 mm M = 8	1 017420018
• 1742R-A M10 ØxL = 13x24 mm M = 10	1 017420020

The prices shown are for 20 pieces
• The prices shown are for 10 pieces

1742/C4

riveting pliers item 1742
with assortment of 400 threaded
steel insets



1742/C4 1 017420005

	M	Ø mm	n.
1742R-A/M3	3	5	100
1742R-A/M4	4	6	100
1742R-A/M5	5	7	100
1742R-A/M6	6	9	100

415x155x60 mm - 2,9 kg

1742A

heavy duty riveting pliers for threaded insets,
with 4 interchangeable mandrels



533mm

1742A 1 017420100

M	Ø mm	L mm
5	7	13
6	9	17
8	11	17
10	13	24

1742A/KR

spare pins for item 1742A



1742A/KR M5	M5	1 017420143
1742A/KR M6	M6	1 017420144
1742A/KR M8	M8	1 017420145
1742A/KR M10	M10	1 017420146

 Beta

1742A/C

riveting pliers item 1742A with assortment of 60 threaded steel insets



1742A/C 1 017420105

	M	Ø mm	n.
1742R-A/M5	5	7	20
1742R-A/M6	6	9	20
1742R-A/M8	8	11	10
1742R-A/M10	10	13	10

536x310x80 mm - 2,1 kg

1743

fitting tool for nylon ties

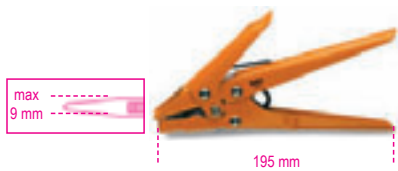

1743 1 017430001

1743T

cable tie cutting tool

• Also suitable for cutting small cables (3x1.5mm²; 1x17mm²)



1743T 1 017430100

1748/...K

nylon cable ties, self-locking head

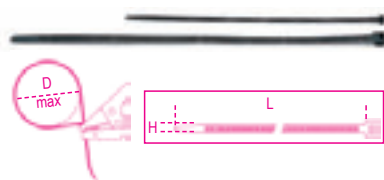

1748/3K 1 017480203

HxL = 2,5x100 mm
D = 18 mm

1748/6K 1 017480206

HxL = 2,5x160 mm
D = 40 mm

1748/7K 1 017480207

HxL = 3,6x150 mm
D = 33 mm

1748/8K 1 017480208

HxL = 3,6x200 mm
D = 46 mm

1748/9K 1 017480209

HxL = 3,6x300 mm
D = 70 mm

1748/14K 1 017480214

HxL = 4,8x190 mm
D = 43 mm

1748/17K 1 017480217

HxL = 4,8x300 mm
D = 72 mm

1748/18K 1 017480218

HxL = 4,8x360 mm
D = 85 mm

1748/23K 1 017480223

HxL = 7,6x300 mm
D = 67 mm

1748/24K 1 017480224

HxL = 7,6x368 mm
D = 88 mm

The prices shown are for 100 pieces

1748B/...K

nylon cable ties, self-locking head

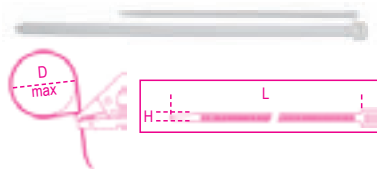

1748B/3K 1 017480303

HxL = 2,5x100 mm
D = 18 mm

1748B/6K 1 017480306

HxL = 2,5x160 mm
D = 40 mm

1748B/7K 1 017480307

HxL = 3,6x150 mm
D = 38 mm

1748B/8K 1 017480308

HxL = 3,6x200 mm
D = 46 mm

1748B/9K 1 017480309

HxL = 3,6x300 mm
D = 70 mm

1748B/14K 1 017480314

HxL = 4,8x190 mm
D = 44 mm

1748B/17K 1 017480317

HxL = 4,8x300 mm
D = 72 mm

1748B/18K 1 017480318

HxL = 4,8x360 mm
D = 86 mm

The prices shown are for 100 pieces

1749

bonding gun varnished metal sheet



1749 2 017490001

1749A

bonding gun, professional model aluminium tube



1749A 1 017490010

1749A/RB

spare spouts for item 1749A

1749A/RB 2 017490051

1749A/RT

front screw plugs for item 1749A

1749A/RT 1 017490052

1749AC

high thrust gun for chemical binders



1749AC 1 017490005

1750

lever operated grease guns



1 g, 550 bar Max

cc	L mm	
500	380	1 017500500
750	450	1 017500750

1750R/1 - 1750R/2

spare flexible hose made from nylon



1750R/1 2 017500030
1750R/2 2 017500040

1750RC

curved rigid hose



	L mm	M mm		
1750RC	150	10x1	2	017500050

1750RT

4-jaw grease fitting "Hydraulic" type



	M mm		
1750RT	10x1	5	017500110

1750RP/1 - 1750RP/2

heads for flat nozzles

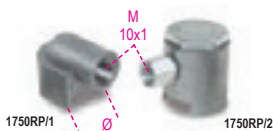

	Ø mm	M mm		
1750RP/1	16	10x1	2	017500115
1750RP/2	22	10x1	2	017500120

1750CG

grease cartridges for item 1750



cc			
400	18	017500140	
600	18	017500160	

1750KG10

lever-operated grease gun, 10 kg, with high-pressure hose, 2 m complete with swivel fitting, to avoid choking hose die-cast aluminium pump body with check valve

3 different pressure levels available:

- 4 g at 275 bar
- 7 g at 206 bar
- 9 g at 137 bar



1750KG10	1	017500100
----------	---	-----------

1750TA

high-pressure, self-locking 6-pin grease nozzle

Once positioned, it remains on axis and connected to nipple; it does not have to be held like common nozzles
Easy to disconnect, even when with pressurized grease
Thread M10x1: suitable for all types of grease guns: electric, pneumatic, manual etc.
Deformation-free up to 550 bar



1750TA	1	017500111
--------	---	-----------

1750M

mini grease gun

- With micro nozzle
- Particularly suitable for pneumatic tools



	cc	D mm	L mm		
1750M	100	43	145	1	017500025

1751

metal pressure oil cans flexible spout



	cc	D mm	L mm		
	200	62	140	4	017510002
	300	75	140	4	017510003
	500	85	140	4	017510005
	750	100	140	2	017510007
	1000	100	140	2	017510011

1751R

spare spout for item 1751



200=1000	5	017510010
----------	---	-----------

1752

plastic pressure cans rigid spouts



cc	D mm	L mm		
200	67	140	4	017520002
300	77	140	4	017520003
500	95	140	4	017520005
700	95	140	2	017520007

1752R

spare spout for item 1752



200=700	5	017520020
---------	---	-----------

1753

plastic pressure oil cans flexible spouts



cc	D mm	L mm		
200	65	190	4	017530002
300	80	190	4	017530003
500	95	190	4	017530005
700	95	190	2	017530007

1753R

spare spout for item 1753



200=700	5	017530020
---------	---	-----------

1754

plastic pressure oil cans flexible plastic spouts



cc	D mm	L mm		
150	60	130	5	017540015
250	65	130	5	017540025

1755

plastic oil bottles retractable spouts



cc	L mm	A mm		
30	160	30	5	017550003
80	170	47	5	017550008
150	230	58	5	017550015

1756

pen oiler



cc	L mm		
5	140	2	017560001

1756B

pen oiler



cc	L mm		
500	280	2	017560220

Beta

1756C

suction gun, 200 ml, made of polypropylene

- Also suitable for braking system fluid
- Double EPDM gasket
- Operating temperature: +0 - +50 °C
- NOT suitable for fuel



1756C 1 017560502

1756D

suction gun, 1500 ml, made of polypropylene

- Double NBR gasket
- Operating temperature: +0 - +50 °C
- NOT suitable for fuel

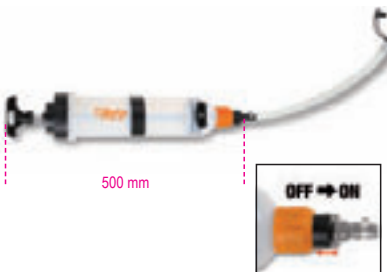

1756D 1 017560515

1756C-2OR

O-rings (pair) for suction guns 1756C

1756C-2OR 1 017560503

1756D-2OR

O-rings (pair) for suction guns 1756D

1756D-2OR 1 017560516

1760DGT

digital automotive multimeter



CE

TECHNICAL DATA
RPM (tachometer):
For 2 and 4 cylinder engines
RPM4 600 - 4000 RPM
RPM4 600 - 12000 RPM (x10 RPM)
RPM2/DIS 300 - 4000 RPM
RPM2/DIS 300 - 6000 RPM (x10 RPM)
Dwell angle: 4-8 CYL
DC voltage: 400mV-4/40/400/1000V
AC voltage: 4/40/400/700V
DC current: 40/400mA-4/20A
AC current: 40/400mA-4/20A
Resistance: 400Ω-4/40/400kΩ-4/40MΩ
Capacity: 40/400nF-4/40/100μF
Frequency: 5/50/500Hz-50/500-10MHz
Duty cycle: 0.1 % - 99.9%
Pulse amplitude: 1 - 10ms
Diode test: Test current 0.3mA
Continuity: <150Ω - Test current <0.3mA
Display: High-contrast, backlit 4-digit LCD
Overvoltage: Category II 1000V
Auto power off: 30 minutes
Power supply: 1 9V battery (included)
Inductive clamp (included)
2 tips (included)
Soft cloth case (included)
Operating manual

1760DGT 1 017600005

Beta

1760B

digital multimeter



CE

SPECIFICATIONS

DC voltage: 200 mV-2/20/200/1000V
 AC voltage: 2-20/200/700V
 DC current: 2/20/200 mA-20 A
 AC current: 2/200 mA-20 A
 Resistance: 200Ω - 2/20/200 kΩ - 2/20 MΩ
 Capacity: 2/20/200 nF - 2/200 μF
 Temperature: -20° + 1000°C / -4 °F ~ +2000°F
 Frequency: 20kHz
 Power supply: 1 9V battery (included)

1760B 1 017600012

1760/OHM

Multimeter/megohmmeter for high voltage insulation testing.
 TRUE RMS indicator



CE

CAT. IV
 600V
 CAT. III
 1000V

Measuring range	Base accuracy
AC/DC voltage: 50mV - 1000V	±0.06% - ±0.1% rdg
AC/DC current: 0.01μA - 10A	±0.5% - ±1% rdg
Resistance: 0.01Ω - 50MΩ	±0.2% - ±2% rdg
Meg OHM: 0.01 - 5000MΩ	±4% rdg. max current 1mA
Capacity: 5nF - 10mF	±1.5% - ±3% rdg
Frequency: 50Hz - 100 MHz	±0.02% - ±0.1% rdg
Temperature: -50 °C - +1350 °C	±0.5% rdg
Diode test: 3V dc	
Continuity test: <30 Ω	

1760/OHM 1 017600025

1760/RMS

industrial digital multimeter
 accurate and sturdy, in a 6-mm co-moulded shell, with antislip, shockproof outer rubber part



CE

Measuring range	Base accuracy
AC/DC voltage	110mV - 600V ±0.8% - ±2% rdg
AC/DC current	110μA - 10A ±1.5% - ±2% rdg
Resistance	110Ω - 40MΩ ±1.2% - ±2.5% rdg
Capacity	11nF - 40mF ±5% - ±10% rdg (up to 11mF)
Frequency	1100Hz - 110 MHz ±1.2% - ±1.5% rdg
Temperature	-32°C - +1000°C ±3% - ±5% rdg
Diode test, 3V DC	±10% rdg
Continuity test	<30 Ω

1760/RMS 1 017600020

1760PA/80

AC/DC amperometric clamp, 80A

Designed to measure low current leakage or absorption values on vehicles



CE

- Range: 1mA-80AAC/DC
- Torch function with white LED
- Backlit LCD display
- Zero setting function
- Hold function
- Auto power off
- Power supply: 2 1.5V AAA-type batteries

1760PA/80 1 017600002



1760PA/AC

amperometric clamp and digital multi-meter

A: AC
 V: AC/DC



CE

SPECIFICATIONS

DC voltage 400 mV - 4/40/400/600 V
 AC voltage 400 mV - 4/40/400/600 V
 AC current 40/400/1000 A
 Resistance 400Ω - 4/40/400 kΩ - 4/40 MΩ
 Frequency 5/50/500 Hz - 5/50/500 kHz - 5/10 MHz
 Capacity 40/400 nF - 4/40/100 μF
 Temperature - 20 °C + 1000 °C / -4 °F + 1832 °F
 Power supply: 1 9V battery (included)

L mm 1760PA/AC 190 1 017600050

1760PA/AC-DC

amperometric clamp and digital multimeter

A: AC/DC
 V: AC/DC



CE

A: AC/DC
 V: AC/DC

SPECIFICATIONS

DC voltage: 0.1mV + 600V
 AC voltage: 0.1mV + 600V
 AC current: 0.01A + 1000A
 DC current: 0.01A + 1000A
 Resistance: 0.1Ω + 40MΩ
 Capacity: 0.001nF + 40 μF
 Frequency: 0.001kHz + 4kHz
 Temperature: -40°C + 1000 °C
 -40°F + 1832°F

1760PA/AC-DC 1 017600000

1760/TC2

combination contact/non-contact digital tachometer



TECHNICAL DATA

- For measuring:
 - non-contact rotational speed (rpm)
 - contact rotational (rpm)
 - and linear surface speed (m/min or ft/min).
- 5-digit LCD display.
- Scale:
 - non-contact speed 2.5÷99,999 rpm
 - contact speed 0.5÷19,999 rpm
 - linear surface speed 0.05÷1,999.9 m/min.
- Frequency: 0.8 sec.
- Power supply: 4 1.5V batteries, AA size, or 6V power supply unit (not included).
- Supplied with the following:
 - adaptor for contact tip measurement;
 - male (contact) rubber tip (2 pcs.);
 - female (contact) rubber tip (1 pcs.);
 - linear measurement tape (1 pcs.);
 - reflecting tapes;
 - instruction manual;
 - plastic case.

	L mm	H mm	
1760/TC2	230	74	1 017600161

1760K

non-contact AC voltage detector with LED mini-torch

Testing range: 200-1000Vac 50/60Hz
CAT III-1000V
Requires 2 AAA batteries (included)



1760K	1 017600140
-------	-------------

1760PT

combination voltage and continuity tester, 12-690V AC/DC

- Functions:
- continuity
 - phase rotation
 - mains testing
 - LED torch



IP64
CATIV
- 600V ;
CATIII -
1000V

1760PT	1 017600150
--------	-------------

1760R/TC2

set of reflecting tapes for item 1760/TC2



1760R/TC2	1 017600561
-----------	-------------

1760/IR800

digital infrared thermometer with dual laser aiming system



TECHNICAL DATA

- Range: -50 °C to +800 °C / -58 °F to +1472 °F
- Scale selection: °C/°F
- Accuracy: ±1.0% or ±1.0 °C to 20 °C
- Laser power: <1mW
- Response: 150ms
- Emissivity: 0.10-1.0 adjustable
- Distance ratio: (D:S) 20:1
- Operating temperature: 0 °C + 50 °C / 32 °F + 122 °F
- Operating humidity: 10% to 90% RH
- Backlit LCD display
- Data storage function
- Auto power off
- Power supply: 1 9V battery (included)
- Soft cloth case (included)
- Operating manual

1760/IR800	1 017600380
------------	-------------

1760/IR1600

digital infrared thermometer with laser aiming system



TECHNICAL DATA

- Range: da -50 °C to +1600 °C / -58 °F to +2912 °F
- Scale selection: °C/°F
- Accuracy: ±1.5% or ±2 °C to 20 °C
- Laser power: <1mW
- Response: 1sec
- Emissivity: 0.10-1.0 adjustable
- Distance ratio: (D:S) 50:1
- Operating temperature: 0 °C + 50 °C / 32 °F + 122 °F
- Operating humidity: 10% to 90% RH
- Backlit LCD display
- Data storage function
- Auto power off
- Power supply: 1 9V battery (included)
- Hard case with aluminium tripod
- Operating manual

1760/IR1600	1 017600460
-------------	-------------

1761

wire twisting pliers with automatic return



L mm	
255	1 017610101

1761RS/1

reversible wire twisting pliers with automatic return



L mm	
220	1 017610130



1762

revolving punch pliers



∅ mm	L mm		
2-2,5-3	210	2	017620001
3,5-4-4,5			

1766

double suction lifter



max kg			
50	2	017660001	

1766A

single suction cup



max kg			
30	2	017660005	

1767PMC

magnetic tool holder, round



1767PMC	1	017670020	

1767PMR

magnetic tool holder, rectangular



1767PMR	1	017670010	

1770

extra flat utility knife, 9 mm snap-off blade

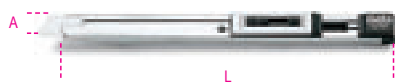

	L mm	A mm		
1770	140	9	10	017700001

1770A

utility knife 9 mm with automatic blade locking mechanism, 3 blades



	L mm	A mm		
1770A	135	9	10	017700025

1770RL

9 mm snap-off blades 10 pieces for utility knives 1770 and 1770A



1770RL	5	017700010		

1770BM

utility knife, 9 mm, 6 blades



	L mm	A mm		
1770BM	140	9	10	017700050

1771

utility knife, 18 mm, supplied with 3 blades



1771	10	017710000		

1771BM

utility knife, 18 mm, 6 spare blades



	L mm	A mm		
1771BM	170	18	10	017710050

1771RL

18 mm snap-off spare blades (10 pieces) for utility knives 1771, 1771BM



1771RL	5	017710010		

1772R

utility knife with retractable trapezoidal blade, supplied with 5 blades



	L mm	A mm		
1772R	125	18	5	017720006

1772H

safety utility knife with retractable blade, supplied with 2 blades



	L mm	A mm		
1772H	170	18	5	017720029

1772RL/2

10 long trapezoidal spare blades, in box, for utility knives, 1772R, 1772H, 1774, 1777BMT, 1777T

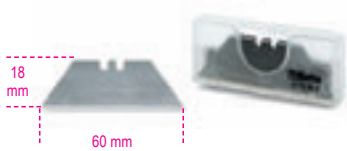

1772RL/2 5 017720017

1773A

utility knife, 25 mm



1773A 10 017730000

1773RL

25 mm blades (10 pieces) for utility knife 1773A



1773RL 5 017730015

1774

multi-function scraper with blade guard



1774 5 017740001

1774A

multifunction scraper, bi-material handle



1774A 1 017740011

1774A/RL

10 blades for multifunction scraper item 1774A

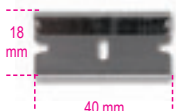

1774A/RL 1 017740511

1777BM

foldaway knife with wire stripping notch, stainless steel blade



1777BM 5 017770100

1777T

foldaway knife with trapezoidal stainless steel blade, 5 spare blades



1777T 5 017770030

1777BMT

foldaway knife with trapezoidal blade 4 adjustable blade depths 4; 9.5; 15.5; 21.5 mm supplied with 3 blades



1777BMT 5 017770050

1778CM

camouflage foldaway knife, hardened steel blade, in case



1778CM 5 017780099

1778D

foldaway knife, stainless steel blade and handle, in case



1778D 5 017780060

1778SCL

foldaway knife with soft carbon look finish, hardened steel blade, in case



1778SCL 5 017780089

1778SAFE

foldaway knife, hardened steel blade, with window breaking hammer, seat belt cutter and knot untying features, in case



1778SAFE 5 017780090

1778SOS

car service knife with window breaking hammer and seat belt cutter features in case



1778SOS 5 017780080

1778V18

foldaway knife,
aluminium handle
• in case



L	A	L1	
mm	mm	mm	
195	25	85	5 017780018

1778W

foldaway knife,
stainless steel blade,
handle with wooden inserts,
in case



L	A	L1		
mm	mm	mm		
1778W	180	22	78	5 017780025

1778X

knives for nautical maintenance, stainless
steel blades, aluminium handles
in case



L	L1	A		
mm	mm	mm		
1778X	185	85	25	2 017780050

1781

slim, long blade scissors



L		
mm		
1781	132	2 017810001

1783

light duty scissors



L	
mm	
215	5 017830021
240	5 017830024

1784

heavy duty scissors



L	
mm	
175	2 017840017
200	2 017840020
250	2 017840025
300	2 017840030

1800/100

lifting airbags (max. lifting force: 100 kg)

- lifting/levelling
- locking doors



A	B	S	
mm	mm	mm	
160	150	2÷55	3 018000000

1808

dual rating soldering iron with steel tips
1824R8



W	V	
mm	V	
20/130	230	1 018080001

1812 150

instant heat soldering iron



W	V	
mm	V	
150	230	1 018120015

1814M

soldering irons
with steel tips



W	V	
mm	V	
25	230	1 018140225
30	230	1 018140230
40	230	1 018140240

1820

soldering irons



1820 30	30W	L = 210mm	1 018200003
1820 60	60W	L = 220mm	1 018200006
1820 80	80W	L = 260mm	1 018200008

1822

high-performance soldering irons



1822 120	120W	LxA = 250x125mm	1 018220012
1822 180	180W	LxA = 250x125mm	1 018220018
1822 320	320W	LxA = 250x140mm	1 018220032



1823 60

digital soldering station
supplied with soldering iron

- Temperature range: 160 °C ÷ 480 °C with ±1% accuracy.
- Memory mode designed to save the temperature selected when switching off the station.
- 3 quick selection keys (200-300-400 °C).

CE



W
60

1 018230060

1823R/60

spare soldering iron for item 1823 60

CE

60W

24V



1823R 60

1 018230066

1824R

spare tips for soldering irons



1824R 08 1808	1 018240100
1824R 12 1812/150	1 018240301
1824R 14-M25 1814M/25	1 018240152
1824R 14-M30 1814M/30	1 018240153
1824R 14-M40 1814M/40	1 018240154
1824R 20 1820/30	1 018240302
1824R 60 1820/60	1 018240303
1824R 80 1820/80	1 018240304
1824R 120-180 1822/120 -/180	1 018240305
1824R 320 1822/320	1 018240307
1824R ST-60 1823-60	1 018240308

1825B

soldering tin wire with antioxidant

- 1 mm²; 250 g
- Sn 99.3%; Cu 0.7%



1825B

1 018250251

1827

gas soldering iron, adjustable

CE



240 mm

1827

1 018270001

1827PC

spare conical tips for item 1827

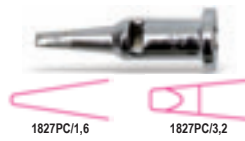

1827PC/1,6

1827PC/3,2

1827PC 1,6

1 018270501

1827PC 3,2

1 018270502

1827PCL

spare knife tips for item 1827



1827PCL 2,4

1 018270503

1827PFL

spare naked flame tips for item 1827



1827PFL

1 018270504

1827/K

gas soldering iron with 7 accessories
in case with soft polyethylene
foam base



CE

- Power: 30 watts to 125 watts
- Tip temperature can be adjusted between 250 °C and 500 °C
- Gas flow regulator
- Warm-up time: 15 seconds
- Tank contains gas for 120 minutes' non-stop operation
- Clear tank for monitoring gas level
- Can be refilled with butane gas

1827/K

1 018270100

1830T

dissoldering pipe with antistatic plastic (PTFE)
nozzle



L
mm
190

5 018300021

1834L/USB

rechargeable high-brightness LED torch,
made of sturdy anodized aluminium,
up to 450 lumens
USB recharged

flat battery indicator (appearing when battery charge is down to 20%)
battery life: 4h



IPX6

MICRO USB

L
mm
220

1 018340075

1834RB-L/USB

spare battery for item 1834L/USB

1834RB-L/USB

1 018340975

1834PS

high-brightness LED torch,
made of sturdy, anodized aluminium,
up to 300 lumens

- Batteries (not included): 2xAAA (life 9/29 h)
- Lumens: 300>100>OFF
- IPX6



L
mm
150

1 018340310

1834PM

high-brightness LED torch,
made of sturdy, anodized aluminium,
up to 350 lumens

- Batteries (not included) :
 - 1xAAA (life 11/33 h)
 - 2xAAA (life 13/39 h)
 - 3xAAA (life 15/45 h)
- Lumens: 350>40>OFF
- Charge indicator
- IPX6



L
mm
140 1 018340320

1834PL

high-brightness LED torch,
made of sturdy, anodized aluminium,
up to 500 lumens

- Batteries (not included) :
 - 1xAA (life 20/60 h)
 - 2xAA (life 28/84 h)
 - 3xAA (life 36/108 h)
- Lumens: 500>40>OFF
- Charge indicator

•IPX6



L
mm
210 1 018340325

1834PXL

high-brightness LED torch,
made of sturdy, anodized aluminium,
up to 1350 lumens

- Batteries (not included) : 3xD (life 36/108 hr)
- Lumens: 1350>450>OFF
- Charge indicator
- IPX6



L
mm
315 1 018340330

1834RR

LED torch,
rechargeable in cigarette lighter socket
Adjustable focus
Rechargeable in cigarette lighter socket, 10-28V DC
IP30
130 lumens



1834RR 1 018340520

1835/1

LED inspection torch,
made of sturdy anodized aluminium

1xAAA battery (not included)



L
mm
105 3 018350030

1835/2

LED inspection torch,
made of sturdy anodized aluminium

2xAAA batteries (not included)



L
mm
145 3 018350060

1836A

LED headlamp, dual brightness, with
contactless ON/OFF sensor

- 120/65 lumens
- IP54
- Batteries: 3xAAA included

CE



1836A 1 018360050

1836B

rechargeable LED headlamp, dual brightness,
with ON/OFF sensor

- Contactless ON/OFF sensor
- 160 lumens
- Life: 3-6 h
- IP65

CE



1836B 1 018360200

1837N

magnetic, articulated lamp with high-
brightness LEDs,
up to 400 lumens

- Batteries (not included) :
 - 1xAA (life 25/69 h)
 - 2xAA (life 33/96 h)
 - 3xAA (life 43/124 h)
- Lumens: 400>40>OFF
- Charge indicator
- Adjustable focus
- IPX6



1837N L
mm
450 1 018370002



1837/USB

rechargeable, magnetic, articulated lamp with high-illuminated LEDs
micro USB charger not included

- Dual brightness: 150/450 lumens
- Adjustable focus
- Lithium polymer battery
- Charge indicator (green >85%; red <15%)
- Battery life 4-8 hours (depending on brightness)
- Micro USB charging

IPX6



1837/USB 1 018370051

1837RB/USB

spare battery for item 1837/USB

1837/USB RB 1 018370901

1837PLUS

LED spotlight for building yards

- Brightness: 3000 lumens; adjustable (10%; 25%; 50%; 75%; 100%)
- Power supply: 100-240V AC - 50/60Hz; 26W
- impact protection: IK07
- cable: 5 m / 3x1 mm²
- Dimensions: 235 x 83 x 233 mm

CE

IP67



1837PLUS 1 018370026

Beta

1838/11LED

rechargeable inspection lamp with ultra-high brightness LEDs, lithium polymer battery

- Compact body made of antislip rubber
- Easy-to-replace front glass
- Swinging hook
- With charging station, 110-230Vac
- 320 lumens
- With multidirectional head LED

1838RV/11LED



1838/11LED 1 018380111

1838RA/10-11LED

spare power supplies for items 1838/10LED and 1838/11LED

1838RA/10-11LED 1 018380903

1838RB/10LED

spare battery for items 1838/10LED and 1838/11LED

1838RB/10LED 1 018380902

1838RR/11LED

charging bases for item 1838/11LED

1838RR/11LED 1 018380914

1838RV/11LED

spare scratch-proof glass for lamp 1838/11LED



1838RV/11LED 2 018380905

1838COB

rechargeable inspection LED lamp

- Hangable, with antislip, shockproof rubber body
- Lithium polymer battery
- 55/125 lumens

CE



IP65

1838COB 1 018380010

1838P

rechargeable inspection pen light, with double light emission: lamp and torch

- Compact body made of non-slip rubber
- 50/80 lumens
- Pocket hook
- Magnetic base can be rotated 180 degrees
- Complete with USB/jack charging cable, 3.5mm
- Life: 2.5 hours
- IP20

CE



1838P 1 018380005

Beta

Beta



1838FLASH

rechargeable, ultracompact spotlight, designed to offer the best possible solution for each use

ABUNDANT READY LIGHTING: with a maximum lighting capacity of 720 lumens, and running on both battery and cable, it is always ready to use.

CAN BE PLACED ANYWHERE:

-on flat surfaces: with rubber feet on three sides or 1/4" drive for stands (camera-like standard)

-on metal structures: with unscrewable magnet or hook that can be rotated 360 degrees.

COMPACT: no more than 85x100x155 mm in size, it can be easily replaced in tool bag and used in small areas.

STURDY: designed to withstand extremely severe mechanical stress. Guaranteed durability.



IP65

1838FLASH

1 018380300

1838RB/FLASH

spare battery for item 1838/FLASH

1838RB/FLASH

1 018380930

1838LED/120

LED under bonnet lamp with swivel hook

- 5-m-long oil-proof cable
- 600-lumen LED strip, 7.5W
- Hook opening: 120 ÷ 170 cm



IP65

1838LED/120

1 018380250

1838LED/120-AL

power supplies with spare cables for item 1838LED/120

1838LED/120-AL

1 018380251

1838SL

ultra-thin inspection lamp with ultra-high brightness LEDs.

For jobs in small areas

- power supply: 12V, with lighter socket and battery terminals
- 2.5-m-long cable
- thickness: 6mm
- 345 lumens

CE



1838SL

1 018380101

1838SLR

rechargeable, articulated LED inspection lamp

compact front LED (200 lumens) and head LED (100 lumens) for inspections

lighting body no more than 9 mm thick

operating range: 5/2.5 hours (depending on light level setting) with USB charger

with metal hook and magnet

CE



IP30

1838SLR

1 018380201

1838SN

rechargeable, articulated LED inspection lamp

- articulated
- non-slip rubber body
- double swinging hook
- magnets on base and back for increased adjustability
- with charger 100-240V / 50-60Hz
- double light emission, front and head (spot)
- 250 lumens / spot 150 lumens
- operating range: 3h / spot 3h
- with charge indicator

CE



IP20

1838SN

1 018380132

1838UV

rechargeable UV and white light inspection lamp ideal for detecting leaks

- Compact body made of antislip rubber
- With charger 100-240Vac / 50-60Hz
- 150 lumens / UV

CE



1838UV

1 018380150

1839/R1

transformer with USB output, spare part for items 1834L/USB; 1836B; 1837/USB; 1838COB

1839/R1

1 018390501

1839/R2

USB/jack cable 3.5 mm, spare part for items 1836B; 1838P; 1838COB

1839/R2

1 018390502

1839/R3

USB/MicroUSB cable, spare part for item 1834L; 1837/USB

1839/R3

1 018390503

1840BM

230V inspection lamp, base type: E27

- Bulb not included



IP20

1840BM 230 V 60 W 420 mm

1 018400101

1842LED/BM

Lamp with ultra-high brightness LEDs, 100-240 Vac

- 10-m-long cable
- compact body made of antislip rubber
- easy-to-replace front glass
- swinging hook
- 340 lumens
- with multi-directional head LED light



1842LED/BM 1 018420301

1842LED/ABM

Lamp with ultra-high brightness LEDs, 12-24V AC/DC

- 10-m-long cable
- compact body made of antislip rubber
- easy-to-replace front glass
- swinging hook
- 320 lumens
- with multi-directional head LED light



1842LED/ABM 1 018420311

1843BM

automatic cable reel with 230 Vac inspection lamp, base type E27 and steel protector

- Bulb not included



1843BM 1 018430101

1843R/BM

spare inspection lamp for cable reels, base type E27

- Bulb not included



1843R/BM 1 018430131

1846LED/BM

Automatic cable reel with LED inspection lamp, 100-240 Vac

- With 230/24V safety transformer
- Max. 25 W



1846LED/BM 1 018460301

1846LED/ABM

Automatic cable reel with LED inspection lamp, 12-24V AC/DC

- Max. 60 W



1846LED/ABM 1 018460311

1846R-LED/BM

spare LED lamps

12-24V - AC-DC



1846LED/BM R 1 018460331

1848

automatic cable reel with Schuko type socket

- Crush-resistant rubber cable H07 - 3x1.5 mm² - 15m
- Max. 1600 W with unwound cable
- Max. 1200 W with wound cable



1848 1 018480015

1850B

heat gun

- Pos. I 240 l/min. 300° C
- Pos. II 450 l/min. 500° C
- can be used with gun placed vertically on worktop



1850B L 240 mm H 190 mm 1 018500011

1850C

heat gun

- Pos. I 150-250 l/min 50°C
- Pos. II 150-500 l/min 50-650°C

- digital display
- buttons designed to adjust temperature and flow capacity
- can be used with gun placed vertically on a worktop
- 4 preset programmes and possibility to customize other programmes

- Prog 1 250°C ca. 350 l/min
- Prog 2 350°C ca. 400 l/min
- Prog 3 450°C ca. 500 l/min
- Prog 4 550°C ca. 400 l/min



1850C L 255 mm H 210 mm 1 018500015

1850U...

nozzles for items 1850B and 1850C

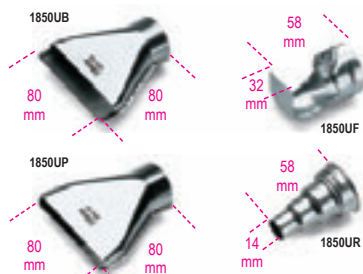

Model	Accessories	Quantity	Part Number
1850UB	B-C	1	018500100
1850UF	B-C	1	018500101
1850UP	B-C	1	018500102
1850UR	C	1	018500103

1851VK

hot glue gun with 12 thermofusibile glue sticks in case

CE



1851VK		1	018510058
--------	--	---	-----------

320x250x50 mm

1851VK-12C

12 thermofusibile glue sticks
Ø 11 mm



1851VK-12C		1	018510062
------------	--	---	-----------

1851VK-12V

12 thermofusibile glue sticks
for painted surfaces
Ø 11 mm



1851VK-12V		1	018510072
------------	--	---	-----------

1852R1750

portable induction heater



CE

- heats and loosens bolts, hubs and bearings without using flames
- allows any type of ferromagnetic metal to be heated

Standard equipment:

- two front attachable coils, Ø 19 and 26 mm, for loosening nuts
- one flat coil for heating surfaces
- one flexible coil, 800 mm long
- supplied in plastic case

Technical data:

- input voltage: 230V AC, 50/60 Hz
- input current: max. 7,5A
- power: max. 1.75 kW

OPTIONAL EQUIPMENT

Coils are also available in other sizes

BENEFITS

Time saving: quick, extremely accurate heating
Fire safety: does not produce flames, maximum operator safety
Functional: can be used with one hand, and coils can be easily interchanged

FIELDS OF APPLICATION

Automotive industry
Industrial maintenance
Aviation industry
Naval industry
Petrochemical industry

1852R1750		1	018520175
-----------	--	---	-----------

480x370x130 mm - 4,5 kg

1852S-L

side attachable coils



Model	Ø mm	Quantity	Part Number
1852S-L 19	19	1	018520501
1852S-L 20	20	1	018520502
1852S-L 23	23	1	018520503
1852S-L 26	26	1	018520504
1852S-L 32	32	1	018520505
1852S-L 38	38	1	018520506
1852S-L 45	45	1	018520507

1852S-F

front attachable coil



Model	Ø mm	Quantity	Part Number
1852S-F 19	19	1	018520508
1852S-F 20	20	1	018520509
1852S-F 23	23	1	018520510
1852S-F 26	26	1	018520511
1852S-F 32	32	1	018520512
1852S-F 38	38	1	018520513
1852S-F 45	45	1	018520514

1852S-FLESS

flexible coil



1852S-FL 500		1	018520515
1852S-FL1000		1	018520517
1852S-FL1500		1	018520518

1852 S-PIATTE

flat coil



1852S-PIATTE		1	018520516
--------------	--	---	-----------

 Beta

 Beta

1860 140A

DC inverter welding machine for MMA and TIG electrode steel welding.
Compact and easy to carry

Arc force, hotstart, anti-sticking and thermostatic protection features

Adjustment current: 5+140A
Power supply: 1x230V

Use factor (40 °C) :

25% - 140 A

60% - 100 A

100% - 90 A

Delayed fuse: 16 A

Protection: IP23S

Usable electrodes: Ø 1.5- 4mm rutilic, basic, stainless steel, cast iron etc.

supplied with 16mm² cables



CE

1860 140A 1 018600004

1860 160A

DC inverter welding machine for MMA and TIG electrode steel welding.
Compact and easy to carry

Arc force, hotstart, anti-sticking and thermostatic protection features

Adjustment current: 5+160A
Power supply: 1x230V

Use factor (40 °C) :

30% - 160 A

60% - 1030 A

100% - 110 A

Delayed fuse: 25 A

Protection: IP23S

Usable electrodes: Ø 1.5 - 4mm rutilic, basic, stainless steel, cast iron etc.

Supplied with 25mm² cables



CE

1860 160A 1 018600006

1860RC

spare cables for inverter welding machines
item 1860

electrode holder cable length: 2.5m
earth cable length: 1.8m



1860RC/140A 1 018600604
1860RC/160A 1 018600606

7042LCD

Auto-darkening LCD mask, for electrode welding; MIG/MAG; TIG and plasma.
Solar cells power supply and lithium batteries for outstanding LCD filter life

- Viewing area: 98x43 mm
- Darkening shade: DIN 9-13, externally adjustable
- UV/IR protection
- Light to dark time: 1/25000 s
- Dark to light time: 0.25-1s
- Adjustable darkening sensitivity and delay
- Auto on/off
- Grinding feature
- Optimized shape to make it easier to breathe with pulled-down screen



CE

7042LCD 1 070420001

7042LCD/RV

scratch-proof lens protector for item 7042LCD

7042LCD/RV 2 070420101

7042LCD/RV-INT

inside lens for item 7042LCD

7042LCD/RV-INT 2 070420102

1870

solid and fluid vacuum cleaner, 20 l

- single-stage by-pass motor
 - voltage: 230/240 V
 - frequency: 50/60 Hz
 - max. power: 1200 W
 - airflow rate: 58 l/sec.
 - max. suction power: 190 mbar
 - max. drum capacity: 20 l, made of antistatic PP
 - acoustic emissions: <70 dB(A)
 - cable length: 5 m
 - trolley for accessories
- STANDARD ACCESSORIES, Ø 36 mm
- 1 corrugated hose with ergonomic handle
 - 2 hard extension tubes
 - 1 multiuse brush for floors and fluids
 - 1 flat nozzle
- FILTERING SYSTEMS
- 1 surface filter cartridge 1900 cm² - 12 µm nom.
 - 1 anti-foam filter PPI 45/PPI 30

CE



IPX4

1870 1 018700020

1872L

solid and fluid vacuum cleaner, 35 l,
"L" class certified

- two-stage by-pass motor
 - voltage: 230/240 V
 - frequency: 50/60 Hz
 - max. power: 1100 W
 - airflow rate: 55 l/sec.
 - max. suction power: 220 mbar
 - max. drum capacity: 35 l, made of antistatic PE-HD
 - acoustic emissions: <68 dB(A)
 - cable length: 6 m
- STANDARD ACCESSORIES, Ø 36 mm
- 1 corrugated hose with ergonomic handle
 - 2 plastic extension tubes
 - 1 combined brush frame
 - 1 section with fluid collection hoses
 - 1 flat nozzle
- FILTERING SYSTEMS
- 1 disposable fabric bag; filtration class: "L"
 - 1 filter cartridge; IFA class: "L"
 - 1 anti-foam filter PPI 45/PPI 30
 - 2 post-filters made of PP-laminated PET

CE



IPX4

1872L 1 018720135

1873

solid and vacuum cleaner, 30 l,
stainless steel drum

- two-stage by-pass motor
- voltage: 230/240 V
- frequency: 50/60 Hz
- max. power: 1100 W
- airflow rate: 55l/sec.
- max. suction pressure: 220 mbar
- max. drum capacity: 30 l, made of stainless steel
- acoustic emissions: <61 dB(A)
- cable length: 6 m
- trolley for accessories

STANDARD ACCESSORIES, Ø 45 mm

- 1 corrugated hose with ergonomic handle
- 2 stainless steel extension tubes
- 1 industrial brush frame
- 1 industrial section for carpets
- 1 industrial section with fluid collection hoses
- 1 flat nozzle

FILTERING SYSTEMS

- 1 filter paper bag
- 1 surface filter cartridge 1900 cm², 12 µm nom.
- 1 anti-foam filter PPI 45/PPI 30

1874

solid and fluid vacuum cleaner, 50 l,
stainless steel drum

- two-stage by-pass motor
- voltage: 230/240 V
- frequency: 50/60 Hz
- max. power: 1350 W
- airflow rate: 55 l/sec.
- max. suction pressure: 240 mbar
- max. drum capacity: 50 l, made of stainless steel
- acoustic emissions: <63 dB(A)
- cable length: 6 m
- trolley for accessories

STANDARD ACCESSORIES, Ø 45 mm

- 1 corrugated hose with ergonomic handle
- 2 stainless steel extension tubes
- 1 industrial brush frame
- 1 industrial section for carpets
- 1 industrial section with fluid collection hoses
- 1 flat nozzle

FILTERING SYSTEMS

- 1 filter paper bag
- 1 surface filter cartridge 5200 cm², 12 µm nom.
- 1 anti-foam filter PPI 45/PPI 30

1870-72/FL

fluid vacuum cleaning filter
for items 1870 - 1872 - 1873 - 1874



1870 72/FL

1 018700027

1872L 35/FC

cartridge filter, "L" class,
for item 1872L 35



1872L 35/FC

1 018720144

1872L 35/5S

5 disposable fabric bags, "L" class



1872L 35/5S

1 018720136

1873-30/5S

5 vertical paper bags for item 1873



1873 30/5S

1 018730031

1874-50/5S

5 vertical paper bags for item 1874



1874 50/5S

1 018740051

CE



1873 30

1 018730030

CE



1874 50

1 018740050

1870-20/5S

5 horizontal paper bags for item 1870



1870 20/5S

1 018700021

1870-72 /FC

cartridge filter 1900 cm² 12 - µm nom.
for items 1870 - 1872 - 1873



1870-72 /FC

1 018700026

 **Beta**

1874-50/FC

cartridge filter 5200 cm² - 12 µm nom.
for item 1874



1874 50/FC 1 018740056

1879

9.5 l manual/pneumatic operation fluid
extractor



1879 1 018790001

1879R/K4

kit of 4 spare tubes for fluid extractor 1879



1879R/K4 1 018790504

1880

manual barrel pump



1880 gr 240 1 018800001

1881

pneumatic barrel pump, ratio 3:1



1881 l/min 14 1 018810001

1882

oil gun with flexible end and automatic drip
catcher

- 1/2"
- Maximum delivery rate: 65 l/min
- Maximum operating pressure: 100 bar
- Lockable delivery lever



1882 1 018820010

1883

digital litre counter for oil

- 1/2"
- Shockproof rubber coating
- Battery: 1 CR2 (included)
- Max. delivery rate: 0÷35 l/min
(0÷9 gal/min)
- Max. pressure: 50 bar
(750 psi)
- Viscosity: 8÷5000 mPas
- Tolerance: ±0.5%

CE



1883 1 018830035

1883NC

male-male nipple, 1/2,
for items 1882 and 1883



1883NC 1 018830135

1889

steel handling and storage base
for 2 200-l barrels

- Completely hot painted with epoxy powder
- Easy to carry with a fork lift truck or a transpallet
- Support cannot be placed under any part

CE

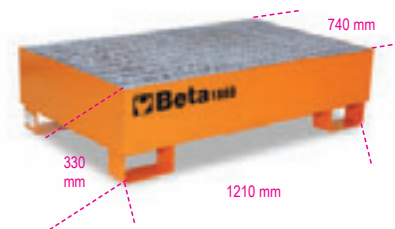

1889 1 018890200

1895 6

ultrasonic cleaning tank,
6 l
with special degas function

CE



1895 6 1 018950060

2250-O

heavy duty swivel creeper seat with tray



2250-O 1 022500011

2251-O

heavy duty swivel creeper seat with drawers



2251-O 1 022510011

2252

seat with castors

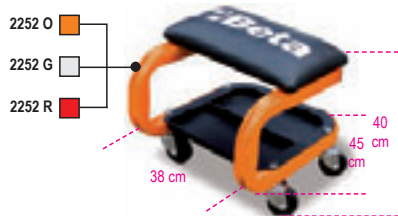

2252-O	1	022520001
2252-G	1	022520002
2252-R	1	022520003

2252KR4

spare seat castors



2252KR4	1	022520900
---------	---	-----------

2254T

kneeling pad

made from non-slip EVA foam



2254T	1	022540047
-------	---	-----------

2258-O

heavy duty creeper with tool chest



2258-O	1	022580011
--------	---	-----------

3027 10

hydraulic bench press with moving piston

Maximum capacity: 10 t

CE



3027 10	1	030270010
📦	90 kg	

3027 20

hydraulic press with moving piston
20 t

Maximum capacity: 20 t

CE



3027 20	1	030270020
📦	140 kg	

3027 30

hydraulic press with moving piston and hoist

Maximum capacity: 30 t

CE



3027 30	1	030270030
📦	230 kg	

3027 50

hydraulic press with moving piston and hoist

Maximum capacity: 50 t

CE



3027 50	1	030270050
📦	350 kg	

3027/KP

set of pin punches and plate
for press item 3027

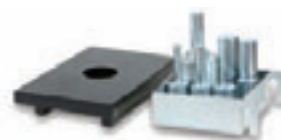

3027/KP10	3027 10	1	030270510
3027/KP20	3027 20	1	030270520
3027/KP30	3027 30	1	030270530
3027/KP50	3027 50	1	030270550

3027/KPP50

pedal control for hydraulic press item 3027
20-30-50



3027/KPP50	1	030270555
------------	---	-----------

VEHICLE REPAIR



83

half-moon ring wrenches



ISO 3318

mm	L mm		
8x10	126	3	000830008
10x12	137	3	000830010
11x13	138	3	000830011
14x17	183	3	000830014
15x17	184	2	000830015
16x18	196	2	000830016
19x22	231	2	000830019



83/S3	11x13-14x17-19x22 mm	1	000830081
83/S5	10x12-11x13-15x17-16x18-19x22 mm	1	000830085

83AS

half-moon ring wrenches



mm	L mm		
7/16x1/2	138	2	000830111
9/16x5/8	183	2	000830114
3/4x7/8	230	2	000830119



83AS/3	7/16x1/2-9/16x5/8-3/4x7/8	1	000830181
--------	---------------------------	---	-----------

88

double ended flat ring wrenches, extra-long series



mm	L mm		
8x10	235	2	000880008
12x14	330	2	000880012
13x15	330	2	000880013
16x18	405	2	000880016
17x19	405	2	000880017
21x23	435	2	000880021
22x24	435	2	000880022



88/S7	8x10-12x14-13x15-16x18-17x19-21x23-22x24 mm	1	000880107
-------	---	---	-----------

437C

set for repairing damaged spark plug threads, M14x1.25 mm

- Helicoids height: 8.40 - 12.40 - 16.40 mm (5 pcs/size)



437C	1	004370100
------	---	-----------

437C/...

stainless steel helicoids for item 437C



H mm		
8.4	1	004370108
12.4	1	004370112
16.4	1	004370116

The prices shown are for 10 pieces

437C/RM14

male thread for spark plugs M14x1.25



437C/RM14	1	004370124
-----------	---	-----------

437U/09

assortment for repairing damaged threads M5-M6-M8-M10-M12



437U/09	M5X0,8 M6X1,0 M8X1,25 M10X1,5 M12X1,75	1	004370550
---------	--	---	-----------

370x230x55 mm - 2 Kg

437U/E-M...

stainless steel helicoids



	H mm		
M5	7.5	1	004370555
M6	9	1	004370556
M8	12	1	004370558
M10	15	1	004370560
M12	18	1	004370562

Prices refer to 25 pieces (10 for size M12)

437U/PM

bits and taps for item 437U/09



M5	1	004370565
M6	1	004370566
M8	1	004370568
M10	1	004370570
M12	1	004370572

437K/8

tool assortment for repairing axle shaft threads

- Allows original thread to be rectified and dressed.
- Kit contents:
 - Metric sizes: 20x1.25 - 20x1.5 - 22x1.00 - 22x1.5 - 24x1.5 - 24x2.00
 - Inch sizes: 3/4x20 - 13/16x20



437K/8	1	004370020
--------	---	-----------

200x110x30 mm



437K/16

tool assortment for repairing damaged threads on brake caliper brackets M9x1.25



437K/16 1 004370016

210x150x50 mm

437K/33

tool assortment for repairing damaged spark plug threads

Bushes:
M8x1.0 - M10x1.0 - M10x1.25 - M12x1.25
Taps:
M8x1.0 - M10x1.0 - M10x1.25 - M12x1.0 - M12x1.25 - M14x1.25



437K/33 1 004370133

210x150x50 mm

720LC

wheel nut impact sockets, with coloured polymeric inserts



mm	Ø mm		
17	26,5		2 007200637
19	28,5		2 007200639
21	30,3		2 007200641
22	32,4		2 007200642
24	34,6		2 007200644



720LC/C3 1 007200653

17-19-21 mm

148x132x44 mm - 860 g



1/2"



720LC/S5 1 007200645
17-19-21-22-24 mm

720IC

spare coloured polymeric inserts for impact sockets 720LC-720LCL



	mm		
720IC 17	17		1 007200687
720IC 19	19		1 007200689
720IC 21	21		1 007200691
720IC 22	22		1 007200692
720IC 24	24		1 007200694

720LCL

wheel nut impact sockets with coloured polymeric inserts, long series



mm	Ø mm		
17	26,5		1 007200737
19	28,5		1 007200739
21	30,3		1 007200741



1/2"



720LCL/C3 1 007200753

210x50x150 mm - 1,65 kg

720MRC

impact socket with polymeric insert for Mercedes wheel screw



1 007200631

17 27 85 1/2

720TC

impact torsion bars, coloured, for motor vehicle wheel nuts, with 1/2" male and female square drives

1/2"

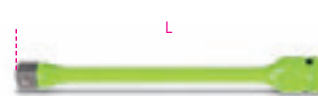

Nm	L mm		
90	200		1 007200769
100	200		1 007200770
110	200		1 007200771
120	200		1 007200772
135	200		1 007200773

1/2"



720TC/S5 1 007200779

90-100-110-120-135 Nm

260x50x175 mm - 1,35 kg

955

tubular spark-plug wrench chrome-plated, hexagon end

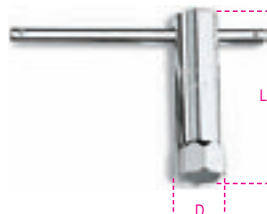

mm -"	D mm	L mm	
16	21	86	3 009550016
5/8			
20,8	29	86	3 009550021
13/16			

956C

1/2" square drive spark plug sockets chrome-plated, hexagon ends



ISO 11168

mm -"	Ø mm	L mm	
14	18,8	70	3 009560008
9/16			
16	21,4	70	3 009560010
5/8			
17,8	23,6	70	3 009560011
11/16			
20,8	27,0	70	3 009560012
13/16			

956E

3/8" square drive spark plug sockets
chrome-plated, hexagon ends

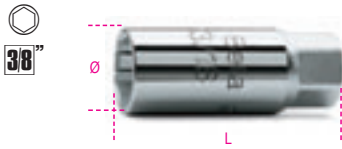

ISO 11168

mm -"	Ø mm	L mm		
14	18,8	70	3	009560018
9/16				
16	21,4	70	3	009560020
5/8				
17,8	23,6	70	3	009560021
11/16				
20,8	27,0	70	3	009560022
13/16				

956F

3/8" square drive spark plug sockets



mm -"	Ø mm	L mm		
14	18,8	70	1	009560114
9/16				
16	20,5	70	1	009560116
5/8				

956L

1/2" square drive spark plug sockets,
bi-hex ends, long series



mm -"	Ø mm	L mm		
14	20,2	250	2	009560214
9/16				
16	24,0	250	2	009560216
5/8				
17,8	24,0	250	2	009560217
11/16				
20,8	28,5	250	2	009560221
13/16				

957

T-handle spark plug wrenches
with swivelling sockets

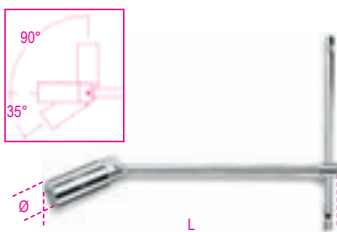

ISO 11168

mm -"	Ø mm	L mm		
16	21,4	275	3	009570000
5/8				
20,8	27,0	275	3	009570001
13/16				

959

T-handle spark plug wrenches
with swivelling sockets, standard series

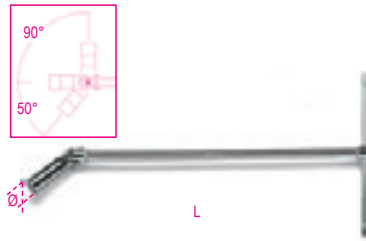

ISO 11168

mm -"	Ø mm	L mm		
14	18,8	483	3	009590009
9/16				
16	21,4	483	3	009590010
5/8				
20,8	27,0	527	3	009590011
13/16				

959R

rubber inset and spare spring
for items 956C - 956E - 957 - 959

959R/14	3	009590223
956C/14-956E/14		
959R/16	3	009590224
956C/16-956E/16		
957/16-959/16		
959R/17,8	3	009590225
956C/17,8-956E/17,8		
959R/20,8	3	009590226
956C/20,8-956E/20,8		
957/20,8-959/20,8-959L		

960

1/2" square drive socket
for Diesel engine injectors



mm	Ø mm	L mm		
27	36,5	77	2	009600027

960A

1/2" square drive socket
for Diesel engine injectors

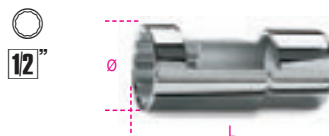

mm	Ø mm	L mm		
27	36,5	77	2	009600017

960BT

sockets for injector electrical connections

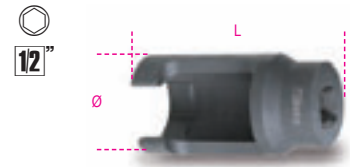

mm	Ø mm	L mm		
25	37,0	78	1	009600125
27	39,7	78	1	009600127
29	42,0	78	1	009600129
30	43,0	78	1	009600130

960BT/B

sockets for injector electrical connections

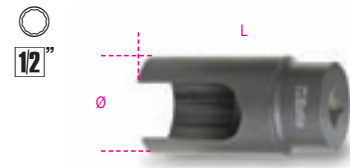

mm	Ø mm	L mm		
29	38,5	77	1	009600128

960F

socket for nozzle holder ring nuts

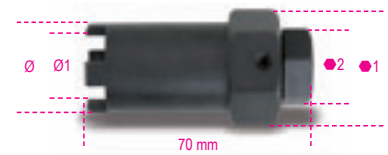

mm	Ø mm	Ø1 mm	Ø2 mm		
28,3	22	32	22	1	009600148

960G

socket for Diesel engine injectors
of Mercedes-Benz trucks



mm	Ø mm	Ø1 mm	L mm		
28,5	22	32	122	1	009600151

960L

socket
for nozzle holder ring nuts



mm	Ø mm	L mm		
30	22	122	1	009600153

 **Beta**

960M

socket
for nozzle holder ring nuts

12"

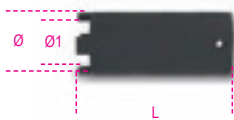

Ø mm	Ø1 mm	L mm	
28,5	22	72	1 009600154

960H/C4

set of sockets for nozzle holder ring nuts



960H/C4	1 009600152
---------	-------------

960S

1/2" square drive socket
for Diesel engine injectors

12"



Ø mm	L mm	
22	82	1 009600022

960SL

sockets for Lambda probes
with 1/2" female square drives

12"



Ø mm	L mm	
960SL85	33	2 009600085
960SL110	33	2 009600110

960SN

Diesel engine glow plug wrenches

14"

3/8"



Ø mm	Ø mm	□ mm	L mm	
8	12,0	1/4	60	2 009600834
9	13,3	1/4	60	2 009600835
10	14,5	3/8	70	2 009600836
11	15,8	3/8	70	2 009600837
12	17,0	3/8	70	2 009600838

960/22EP

double head swivel socket wrench
for Lambda probes

Double hexagon/bi-hex and 180° joint result in remarkable versatility



L mm	Ø mm	Ø mm	
300	22	22	1 009600052

960AVE

device for testing common rail diesel electrical injectors



960AVE	1 009600245
--------	-------------

430x310x50 mm - 2,0 kg

960K/AVE2

kit of adaptors for item 960AVE

(included in item 960AVE)



960AVE2/K	1 009600249
-----------	-------------

250x150x30 mm - 523 g

960CMB

instrument for controlling compression on petrol engines



Bar 4=17	1 009600250
-------------	-------------

440x370x100 mm - 2,2 kg

960CMB/R2

spare cards for item 960CMB



960CMB/R2	1 009600252
-----------	-------------

960CMD

instrument for controlling compression on Diesel engines



Bar 8=40	1 009600270
-------------	-------------

440x370x100 mm - 2,4 kg

960CMD/R1

spare cards for item 960CMD



960CMD/R1	1 009600271
-----------	-------------

960EPC

Set of tools for removing glow plug electrode



960EPC 1 009600790

350x230x80 mm - 900 g

960E-PI/P

injector washer extractor

- Male thread M10 for use with sliding hammer (Beta 1540)



960E-PI/P 1 009600706

300x90x60 mm

960KC-M8

assortment of tools for removing broken or damaged glow plugs M8

- For glow plugs with thread M8x1.0 mm
- Allows broken glow plugs stuck in head to be easily removed



960KC-M8 1 009600800

400x300x60 mm - 1,5 kg

960KC-M8/M9/M10

assortment of tools for removing broken or damaged glow plugs

- For spark plugs with threads M8-M9-M10



960KC-M8/9/10 1 009600801

380x290x50 mm - 2,3 kg

960KPC

reversible impulse extractor with adjustable torque for glow plugs

Torque can be adjusted in 4 positions:
10-20-30-40 Nm



960KPC 1 009600780

8-9-10-11-12 mm

420x185x60 mm - 2,8 kg

960UC

tool set for removing stuck M8-M9-M10 glow plugs with deformed tips



960UC 1 009600900

960P

pressure/depressure tester with accessories and adaptors



960P 1 009600777

350x320x95 mm - 1,9 kg

960PI

assortment of reamers for cleaning injector seats in plastic case

- For removing residues from injector seats
- Flat reamer, Ø 19 - 15 mm, for universal injectors
 - Flat reamer, Ø 17 - 17 mm, for Delphi/Bosch injectors (BMW/PSA/Renault/Ford)
 - Flat reamer, Ø 19 - 17 mm, for Bosch injectors (Mercedes CDI).
 - Angled reamer, Ø 21 - 17 mm, for Fiat/veco injectors.
 - Handle



960PI 1 009600215

250x130x50 mm - 600 g

960PI/P

assortment of 14 special tools and reamers for cleaning injector seats



Assortment contents:

- 3 flat reamers, \varnothing 19/15 mm - \varnothing 17/17 mm - \varnothing 19/17 mm
- 2 angled reamers, \varnothing 21/17 mm - \varnothing 17/17 mm
- injector washer pulling tool
- cutter cleaning brushes
- injector cleaning brush
- handle and cutter accessories

960PI/P

1 009600216

373x280x61 mm - 2,5 kg

960PI/S

kit for cleaning injector seats

Kit contents:

- 3 steel brushes, \varnothing 18, 22, 25 mm, for cleaning injector seats
- 2 brushes, \varnothing 14 and 16 mm, for cleaning injector seat bottoms
- 6 caps for closing hole connecting with combustion chamber
- 1 brush for cleaning hole connecting with combustion chamber
- 1 flexible bit holder with handle

14



960PI/S

1 009600214

360x140x50 mm - 700 g

960RPI

blowing tool for injectors seat cleaning

for M8x1 - M9x1 - M10x1 - M10x1.25 glow plugs



960RPI

1 009600940

Beta

960PMC

Diesel injector test and calibrating hand pump



Bar Max.
400

1 009600200

960AVL

vapour extractor



Bar Max.
6

1 009600210

960AD/TP2

set of adaptors for item 960TP in plastic case



960AD/TP2

1 009600510

430x310x50 mm - 3,2 kg

961D

Digital electronic videoscope with 5.5 mm probe

- Allows individual still images and video clips to be recorded and played back directly on tool



- Probe with head \varnothing 5.5 mm and length 90 cm
- LCD TFT display, 7" (18 cm), with resolution 800x480
- digital camera with front and side view
- "Cfast"-type probe connection
- image repetition frequency: 15 frames per second
- 2x digital zoom
- micro-USB connector for uploading images
- micro-HDMI video output
- Micro-SD card input
- Micro-USB input
- power supply allows unit to be used while battery is charging
- microphone and speaker for adding and listening to voice annotations while recording/playing back
- Wi-Fi connection

961D

1 009610500

400x340x85 mm - 2,6 kg

961D/CF3,8

1-m probe with 3.8-mm front camera for videoscope item 961D



961D/CF3,8

1 009610511

961D/DC8,5

1-m probe with dual UV camera for videoscope item 961D



961D/DC8,5

1 009610513

Beta

961P6



electronic videoscope
with flexible probe



- Supports SD cards (8 GB)
- Supports flash memories (8 GB)
- Internal memory: 128M
- TV-OUT feature
- Supports video formats (MP4, AVI, 3GP)
- 4 LEDs
- Power supplied by USB port (built-in battery)

SPECIFICATIONS

- Sensor pixels: 640x480
- Maximum resolution: 320x240
- Probe length: 1 m
- Camera diameter: 6 mm
- Video formats: MPEG4, 3GP, AVI, ASF.
- Photo formats: JPEG
- Shooting angle: 0±180°
- Data output: USB cable and SD card
- Power supply: 3.7V 2000 mAh battery

961P6   1 009610000

961P6/S

flexible probes, 6 mm



	L mm		
961P6/S2	2000	1	009610262
961P6/S3	3000	1	009610263

962

tyre levers



L mm	A mm		
300	21	5	009620003
400	25	5	009620004
500	27	3	009620005
600	27	3	009620006

963

pry bar with pointed and flat bent ends





L mm	A mm		
400	23	5	009630001

964

pry bar with pointed and leverage ends





L mm	A mm		
400	46	5	009640001



965

pry bars with flat curved ends



L mm	A mm	L1 mm		
300	16	185	2	009650013
450	20	312	2	009650014
600	20	462	2	009650016





965/S3   1 009650019

966/C3

set of 3 levers with articulated, flat, curved heads



966/C3   1 009660103



L=200-250-300 mm

355x140x65 mm - 1,8 kg

720LS

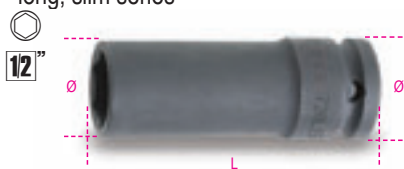
impact sockets,
long, slim series





UNI/ISO 2725		
720LS 36	2	007200386

969B

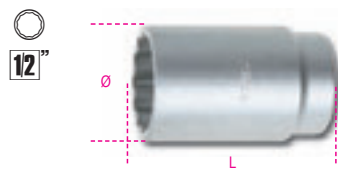
hub nut locking socket



		Ø mm	L mm
1	009690124	24	76
1	009690127	27	76
1	009690130	30	76
1	009690131	31	76
1	009690132	32	76
1	009690134	34	76
1	009690135	35	76
1	009690136	36	76

969/C5

set of 5 hub nut locking sockets
in plastic case



969/C5   1 009690201

 969B 30-32-34-35-36

970EA

impact sockets for axle nuts



		Ø mm	L mm
1	009700398	98	122



970EB

impact sockets for axle nuts



mm	mm	mm		
95	36	126	1	009700595
110	36	133	1	009700410

970Q

impact sockets for rectangular nuts



L mm	□ 3/4"		
56	3/4"	1	009700756
60	3/4"	1	009700760

970B

socket for locking Fiat Daily hub nuts

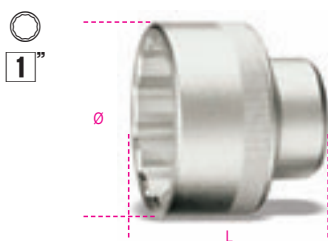

mm	Ø mm	L mm		
65	88	75	1	009700010

970C

octagonal impact sockets for locking hub nuts



mm	□ - Ø mm		
80	41 mm	1	009700808
95	3/4"	1	009700815
100	3/4"	1	009700820
109	41 mm	1	009700829
115	3/4"	1	009700835
120	41 mm	1	009700840

9700T

oval impact sockets for locking trailer hub nuts



L mm	L1 mm	□ - Ø		
65	61	3/4"	1	009700165
80	73	3/4"	1	009700180
96	90	3/4"	1	009700196
111	104	41 mm	1	009700211

971TSP

tyre pressure sensor tool



SPECIFICATIONS

- reading of TPMS sensor information, including: sensor ID
- inflation pressure
- temperature
- battery state
- sensor activation
- universal sensor programming

The tool has a database which supports repair operations, including:

- driving torques
- codes of original spare parts and compatible universal sensors

971TSP

63x142x30 mm

1	009710025
---	-----------

971/C8

torque screwdriver with accessories for controlled tightening of tyre valves with pressure control system



971/C8

1	009710108
---	-----------

583/6	1,2+6 Nm
892/0	
862TX	T10-T15-T20
900L	11-12 mm
986 78	

978 - 979

four-way hexagon wheel nut wrenches

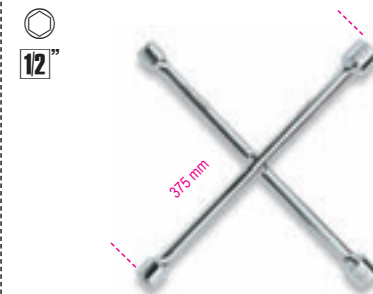

UNI/ISO 6788 DIN 3119

978	2	009780001
-----	---	-----------

17x19x21x22 mm

979	2	009790001
-----	---	-----------

17x19x22x1/2 mm

982

four-way hexagon wheel nut wrench

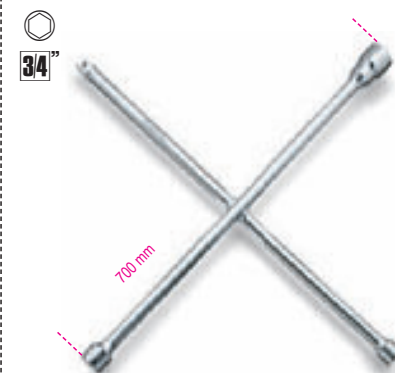

UNI/ISO 6788 DIN 3119

24x27x32x3/4 mm	1	009820001
-----------------	---	-----------

984

wheel nut plastic cap pliers



L mm	H mm	
195	4	1 009840005

985/B7

assortment of 7 guide pins for wheel installation

Included sizes:

- M12x1.25 male
- M12x1.25 female
- M12x1.5 male
- M12x1.5 female
- M14x1.25 male
- M14x1.5 male
- M16x1.5 male



985/B7	1 009850007
--------	-------------

985M

male guide pins for wheel installation



	L mm	
985M M12X1,25	150	1 009850101
985M M12X1,50	150	1 009850102
985M M14X1,25	150	1 009850103
985M M14X1,50	150	1 009850104
985M M16X1,50	150	1 009850105

985F

female guide pins for wheel installation



	L mm	
985F M12X1,25	150	1 009850106
985F M12X1,50	150	1 009850107

986 48

tyre valve screwdriver, short model
automatic valve retention



L mm	L1 mm	
18	48	1 009860048

986 78

tyre valve screwdriver
automatic valve retention



L mm	L1 mm	
18	78	1 009860078

987

tyre valve lever with rubber protection



L mm		
310		1 009870001

987P

tyre valve lever made of plastic

Handle accommodates screwdriver to work on mechanism inside valve



L mm		
335		1 009870011

988/K4

set of 4 scratchproof plastic flat chisels



988/K4	1 009880104
A= 19-21-25-38 mm	

989

wheel balancing weight tool



L mm		
250		2 009890001

1302

double end dolly, round, convex peim head



g		
770		1 013020001

1303

curved dolly



g		
1350		1 013030001

1304

sole dolly



g		
875		1 013040001

1305

toe dolly



1190 g 1 013050001

1305Z

milled toe dolly



1065 g 1 013050002

1306

heel dolly



1040 g 1 013060001

1307

regular dolly



1100 g 1 013070001

1308

egg dolly



1100 g 1 013080001

1309

hatchet dolly



460 g 1 013090001

1310

general purpose dolly



1225 g 1 013100001

1312

anvil dolly



1220 g 1 013120001

1313

buffer dolly



990 g 1 013130001

1314

double end dolly, convex, flat head



760 g 1 013140001

1326

curved angle spoon



560 g 1 013260001

1327

heavy-duty spoon



1075 g 1 013270001

1328

pry and bumping spoon



935 g 1 013280001

1329

double-ended spoon



1800 g 1 013290001

1330

long double-ended spoon



2125 g 1 013300001

1331

bending iron with leather face



1100 1 013310001

1335BM

bumping blade with plastic handle



500 2 013350010

1337/S5

set of 5 stopping knives for car repairers, made of stainless steel

Japanese type
(25-50-75-100-125 mm)



L mm 25-50-75-100-125 1 013370015

1338A - 1338B

adjustable body blade holder with flexible flat blades



	1"	L mm		
1338A	9	360	2	013380001
1338B	12	360	2	013380002

1338

body blade holder for item 1338R



1338 2 013380003

1338R9 - 1338R12

spare body blades for item 1338A-B



1338R9	9	2	013380004
1338R12	12	2	013380005

1342

extra flat chisel with straight cutter



L mm 235 5 013420001

1342PM

extra flat chisel with straight cutter with hand guard

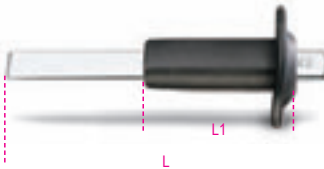

L mm	L1 mm		
235	118	2	013420002

1342PMR

spare hand guard for item 1342



1342PMR 1 013420003

1343

flat chisel with side cutter



L mm 200 5 013430001

1344

feeler gauges for car body repair shops, pair, 10-bladed, with suction cup

suitable for:
• fitting rear windows
• maintaining position during installation



1344 1 013440010

1345

hammer with round, convex face and pein, wooden shaft



1345 2 013450010

1351

hammer with round, flat face and ball pein, wooden shaft



1351 2 013510010

1353

hammer with round, flat face and point pein, wooden shaft



1353 2 013530010



1357Z/45

hammers with flat, round, milled face and square, smooth face, wooden shafts



1357Z/45 2 013570045

1359T

hammer with round, flat face and horizontal pein, wooden shaft

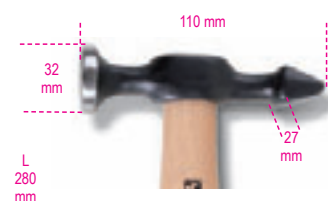

1359 T 2 013590010

1360/K6

aluminium hammer with flat, round face, interchangeable plastic pins and punch

supplied with:
• 4 plastic pins
• 1 punch, adjustable in 2 different lengths, applicable to hammer



L mm 320
Ø mm 34
1 013600006

1362

dent reflector with suction cup allows even the smallest bodywork imperfections to be detected



LxH mm 240 x200
1 013620010

1365/K13

oil pressure pump, 10 t, and bodywork accessories kit in trolley

Kit contents:
• oil pressure pump, 10 t, with 1.5-m-long hose, 1/2" coupling
• piston
• wing opening pliers; capacity: 500 kg
• baseplate, 150x90 mm
• L-shaped base, 50x50 mm
• 4-point punch
• round, knurled punch, Ø 50 mm
• wedge-shaped punch, 43 mm
• 240-mm-long extension
• 450-mm-long extension
• 475-mm-long extension
• rubber head
• male-to-male coupling for installing accessories



1365/K13 1 013650013

900x420x180 mm

1365P10

oil pressure pump
1.5-m-long hose, 1/2" coupling



1365P10 1 013650110

1366A

dent puller with kit of 19 plastic glue tabs

ideal for removing:
• hail dents
• dents caused by doors
• small dents in general



1366A 1 013660200

1366KF

kit of 19 plastic glue tabs for item 1366A



1366KF 1 013660205

1366/K5

pneumatic dent puller, with 1.1 kg hammer face

Kit contents:
• 1 suction cup Ø 75 mm
• 1 suction cup Ø 100 mm
• 1 suction cup Ø 125 mm
• 1 hook



1366/K5 1 013660010

610x240x90 mm

1367/S6

set of punches for installing parking sensors

sizes:
17 - 18 - 19 - 20 - 21 - 22 mm



1367/S6 1 013670100

1367

punches for installing parking sensors



Ø mm
17 1 013670117
18 1 013670118
19 1 013670119
20 1 013670120
21 1 013670121
22 1 013670122

1368

plastic repair kit

- Allows cracked and broken plastic parts to be quickly fixed

Power supply: 220÷240 V with Schuko socket

Heat gun cable length: 3.5 m

Power supply cable length: 1.35 m

2 power adjustments: 35-75 W

Heat gun with brass terminals, 2 staple insertion angles:

0°-90°

Input protection: thermal circuit breaker

Output protection: 10 A fuse

Metal gun pocket



1368

1 013680001

1368G/K400

assortment of 400 clips
for item 1368

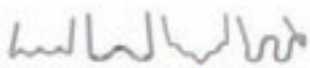

1368G/K400

1 013680140

1368G/OD

corrugated clips, straight, for item 1368

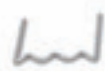

1368G/OD

1 013680100

The prices shown are for 100 pieces

1368G/SD

spiral clips, straight, for item 1368



1368G/SD

1 013680110

The prices shown are for 100 pieces

1368G/CV

convex angle clips for item 1368



1368G/CV

1 013680120

The prices shown are for 100 pieces

1368G/C2U

concave angle clips for item 1368



1368G/C2U

1 013680130

The prices shown are for 100 pieces

1369/C11

assortment of 11 tools



1369/C11

1 013690033

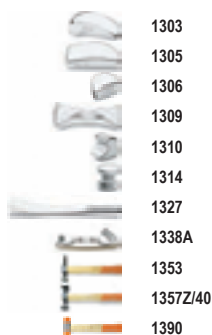

1303

1305

1306

1309

1310

1314

1327

1338A

1353

1357Z/40

1390

470x340x70 mm - 15,2 kg

1428L

socket pullers, long series, for damaged right-hand nuts, with square drive



mm

17

1 014280217

19

1 014280219

21

1 014280221

12"



1428L/B3

17-19-21 mm

1 014280303

1437/C12

assortment of 12 tools for removing air bags



1437/C12

1 014370001

260x160x55 mm - 1,0 kg

1438

universal clutch aligner complete
with 3 expansion mandrels



1438

1 014380001

1438R

spare expansion mandrels
for item 1438



Ø

mm

14÷18

5 014380101

18÷21

5 014380102

22÷25

5 014380103

1438DSG

lever for locking/unlocking DSG dual-clutch
gearbox
from VAG group



1438DSG

1 014380200

1438 SAC

SAC clutch aligning kit

includes kit for applications without guide bearings supplied with 3 and 4 arm plates



1438 SAC 1 014380050

480x380x130 mm - 9,5 kg

1439/K7

angular screwdriver (90°), long series, with blades, in case



Case contents:
- Angular screwdriver
- 1 slotted screw head
- 1 1/4" bit head
- Special blade head
- 7 special blades

1439K7 1 014390101

500x120x60 mm 825 g

1440/...

piston ring compressors



	Ø mm	L mm	
1440/0	40÷75	50	1 014400000
1440/1	57÷125	80	1 014400010
1440/1A	57÷125	100	1 014400011
1440/2	90÷175	80	1 014400020
1440/2A	90÷175	100	1 014400021
1440/3	90÷175	165	1 014400030

1445/1 - 1445/2

piston ring expanders



	Ø mm	
1445/1	50÷100	1 014450001
1445/2	90÷150	1 014450002

1450GC

valve spring compressor with straight and offset jaws

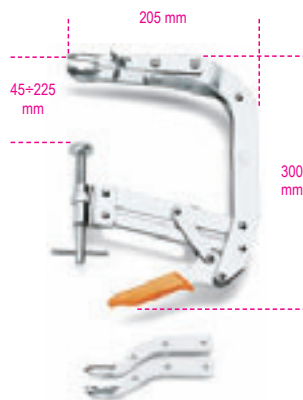

1450GC 1 014500005

1452K

valve spring compressor, with three flanges



1452K 1 014520100

1452PN/K

pneumatic tool for engine valve springs

Thrust pressure: 1400 N



Ø mm	L mm	L1 mm	
16-19-23	230	185	1 014520110
25-30-42			

1455SVP

pneumatic valve grinder

• Pressure: 6 bars

CE



1455SVP 1 014550001

1455SVP/R...

spare parts for item 1455SVP



1455SVP/R1	5	014550501
1455SVP/R2	5	014550502
1455SVP/R3	5	014550503

1458

external butt-ended circlip pliers



DIN 5417

Ø mm 30÷100 2 014580001

1460F

valve seat removing tool



1460F 1 014600010



1461/C3B

timing devices for
Fiat/Alfa/Lancia petrol engines

Engines: 1.2-1.4 16V



1461/C3B

1 014610032

280x245x75 mm 1,5 kg

1461/C5G

timing devices for Fiat/Alfa/Lancia/Opel/
Suzuki/Ford
diesel engines

Engines: 1.3 Multijet



1461/C5G

1 014610053

280x245x75 mm 2,6 kg

1461/C6B

timing devices for
Peugeot/Citroën petrol engines

Engines: 1.0-1.1-1.4-1.6-1.6 16v-1.6Gti-1.6 18V-1.8-1.8 16v-1.9-
2.0-2.0 16v-2.0T-2.0 Hpi-2.2 16v



1461/C6B

1 014610063

310x290x120 mm 3,5 kg

1461/C6G

timing devices for
Peugeot/Citroën diesel engines

Engines: 1.4-1.6-2.0D,1.4-1.6TDCI, 1.4-1.6-2.0-2.2Hdi,
1.5-1.9-2.5D



1461/C6G

1 014610064

385x290x100 mm 3,8 kg

1461/C7B

timing devices for
Renault/Nissan petrol engines

Engines: 1.4-1.6-1.8-2.0 16V



1461/C7B

1 014610072

280x245x75 mm 3,2 kg

1461/C8B

timing devices for Ford petrol engines

Engines: 1.25-1.4-1.6-1.6 SCTi-1.6 Ti-VCT-1.6 16V



1461/C8B

1 014610083

240x210x50 mm 1,8 kg

1461/C8G

timing devices for Ford/Mazda diesel engines

Engines: 1.4-1.6-1.8-2.0-2.2 TDCi, 1.6D 8/16V, 1.8D,
1.8D Turbo, 1.8 TCI, 1.8 TDDi, 2.5D, 2.5D Turbo



1461/C8G

1 014610084

280x245x75 mm 2,2 kg

1461/C9B

timing devices for Opel petrol engines

Engines: 1.0 12V, 1.0-1.2-1.4 16V



1461/C9B

1 014610092

335x145x60 mm 2 kg

1461/C10A

timing devices for
Audi, Seat, Skoda and Volkswagen engines

Engines: 1.9 - 2.0 TDI



1461/C10A

1 014610101

270x120x45 mm - 1,1 kg

1461/C10G

timing devices for Volkswagen/Audi/Seat and Skoda engines

Engines: 1.2-1.6-2.0 TDI CR (common rail)



1461/C10G

310x290x120 mm - 2,8 kg

1 014610103

1461/C11A

timing devices for Renault engines

Engines: 2.0 dCi



1461/C11A

420x280x60 mm - 1,2 kg

1 014610111

1461/C11G

timing devices for Renault engines

Engines: 1.5-1.9-2.2-2.5 DCI



1461/C11G

310x290x120 mm - 3,8 kg

1 014610113

Beta

1461/C12A

timing devices for Fiat engines

Engines: 1.9-2.2 JTS and 1.9 JTD Euro 4



1461/C12A

280x245x75 mm - 1,8 kg

1 014610123

1461/C12G

timing devices for Fiat/Alfa/Lancia diesel engines

Engines: 1.9 JTD, 1.6-1.9-2.0 Multijet



1461/C12G

280x245x75 mm - 2 kg

1 014610124

1461/C13A

timing devices for Fiat 0.9 Twinair turbo engines



1461/C13A

240x210x50 mm - 1,7 kg

1 014610133

1461/C13B

timing devices for Fiat 1.4 Multiair engines



1461/C13B

240x210x50 mm - 2,8 kg

1 014610134

1461/C16

timing devices for BMW 2.0-3.0 diesel engines complete with pump puller
Engines: 2.0-3.0 diesel



1461/C16

335x145x60 mm - 4,3 kg

1 014610160

1461/C17

timing devices for Volkswagen, Seat and Skoda engines

Engines: 1.2 6-12V



1461/C17

142x102x40 mm - 1,5 kg

1 014610170

Beta

Beta

1461/C17B

timing devices for Volkswagen/Audi/Seat and Skoda petrol engines

Engines: 1.2 TSI



1461/C17B

1 014610171

1461/C18B

timing devices for Volkswagen/Audi/Seat and Skoda petrol engines

Engines: 1.6-1.8-1.8T, 1.4-1.6-1.8-2.0 16V, 1.4-1.6-2.0 FSI



1461/C18B

1 014610182

310x290x120 mm 2,5 kg

1461/C19

timing devices for Ford Duratorq engines

Engines: 2.0-2.2-2.4 DIESEL



1461/C19

1 014610190

420x185x60 mm - 1,5 kg

1461/C20G

timing devices for Fiat Iveco/Peugeot/Citroën/Ford diesel engines

Engines: 2.2-2.3-3.0 Multijet



1461/C20G

1 014610221

385x290x100 mm 5,5 kg

1461/C21G

timing devices for Renault diesel engines

Engines: 1.6 dCi



1461/C21G

1 014610222

310x290x120 mm 3 kg

1461/C22B

timing devices for Peugeot/Citroën petrol engines

Engines: 1.0-1.2 VTi



1461/C22B

1 014610223

280x245x75 mm 2 kg

1461/C23B

timing devices for Opel petrol engines

Engines: 1.0 - 1.2 - 1.4 ecoflex



1461/C23B

1 014610224

280x245x75 mm 2,5 kg

1461/C24B

timing devices for Mini-Peugeot/Citroën petrol engines

Engines: 1.4 - 1.6 (N12-N14)



1461/C24B

1 014610225

280x245x75 mm 2,8 kg

1461/C25G

timing devices for Mini diesel engines

Engines: 1.6 diesel (W16D)



1461/C25G

1 014610226

270x120x45 mm 1 kg

Beta

1461/C26B

timing devices for Fiat/Alfa Romeo/Lancia petrol engines

Engines: 1.2-1.4 8v



1461/C26B 1 014610227

280x245x75 mm - 1,7 kg

1461/C27G

timing devices for Bmw diesel engines

Engines: 1.6-2.0D (N47-N47S)



1461/C27G 1 014610228

280x245x75 mm - 2 kg

1461/C28B

timing devices for Volkswagen, Seat and Skoda petrol engines

engines: 1.0 - 1.0 Bluemotion Tech
1.0 Ecofuel/Ecomotive - 1.0 Green Tech



1461/C28B 1 014610229

280x245x75 mm - 1,7 kg

1461/C29B

timing devices for Ford petrol engines
engines: 1.0 EcoBoost



1461/C29B 1 014610209

280x245x75 mm - 2,6 kg

1461/C30G

timing devices for Volkswagen/Audi/Seat and Skoda diesel engines

engines: 1.6-2.0 CR TDI
for engines built as from 2012



1461/C30G 1 014610231

280x245x75 mm - 2 kg

1462CF/C6

set of 6 single-ended bi-hex wrenches for fuel injector connectors

sizes:
12-14-16-17-18-19 mm



1462CF/C6 1 014620006

260x145x60 mm

1462CF

single-ended bi-hex wrenches for fuel injector connectors



mm	
12	1 014620012
14	1 014620014
16	1 014620016
17	1 014620017
19	1 014620019
18	1 014620018

1462/KD

tool assortment for removing Denso injectors, complete with hammer



1462/KD 1 014620060

335x210x80 mm - 4,8 kg

1462/KI

assortment of common rail diesel injector pullers

Allows DELPHI-BOSCH-SIEMENS-DENSO injectors to be removed



1462/KI 1 014620235

530x470x140 mm - 20 kg

Beta

1462/KMRC

tool assortment for removing injectors from Mercedes 2.1L, 2.2L, 3.0 V6 and Chrysler engines

For Bosch (2.1 and 2.2L) and Delphi (3.0) injectors
Injectors can be removed without removing engine.
Particularly suitable for following car models:
Mercedes Vito, Vario, CLK, Sprinter, Viano, M, GL, C, GLK, E, CLS, S, R, G Classes
Chrysler 300 C



1462/KMRC

1 014620070

310x300x118 mm - 3,5 kg

1462/KU

universal tool assortment for removing diesel common rail injectors

Complete with pliers and hammer



1462/KU

1 014620100

390x290x100 mm - 4,5 kg

1462AD/BSC

adapter for removing Bosch common rail injectors

For use with items Beta 960KI and Beta 1462/KU



1462AD/BSC

1 014620435

1462AD/SMN

adapter kit for removing Siemens and Denso injectors

For use with item Beta 960KI/1462KI



1462AD/SMN

1 014620436

1462PIM

injector maintenance plates, pair
vice locking sections:
Ø 11-12-13-14-16-19-20 mm



1462PIM

1 014620502

1463/KIT

valve timing system pulley locking kit



1463/KIT

1 014630001

280x140x75 mm - 1,2 kg

1464T

digital pressure and compression tester

SPECIFICATIONS

- 5" touch screen display
- rechargeable polymer lithium battery
- complete with 80 bar sensor (for low pressure) and USB cable



CE

1464T

1 014640050

1464AP

set for testing high pressure system in common rail diesel engines, with item 1464T

Complete with:
- high pressure pipe set
- fittings
- 2,000 bar sensor



1464AP

1 014640450

1464APB

set for testing high pressure system in FSI petrol engines, for use with item 1464T

comes with 200 bar sensor and connectors



1464APB

1 014640500

1464IC

complete set of dummy injectors and dummy glow plugs for item 1464T

Makes it possible to connect to the engine to check compression in diesel engines with digital tester 1464T.



Contents:

- 22 dummy glow plugs
- 5 dummy injectors
- 1 universal dummy injector kit for trucks, marine engines and agricultural machines

1464IC

1 014640350

1464PF

set for testing pressure in braking system,
for use with item 1464T
comes with adapters and connectors



1464PF

1 014640650

1464PT

set for testing turbo pressure,
for use with item 1464T

comes with sensor and connecting cable



1464PT

1 014640550

1464TDI

set for testing pump pressure in TDI engines,
for use with item 1464T

comes with connector



1464TDI

1 014640600

1466/C5

kit of 5 brake bleeding wrenches

kit contents:

- 5 wrenches sizes 7-8-9-10-11 mm
- 1 drain hose with check valve



1466/C5

1 014660100

260x170x50 mm

1467

brake fluid extractor



Pressure: min 5 bar, max 11.5 bar

1467

1,5

1 014670001

1467/RK1

spare tube kit for item 1467



1467/RK1

1 014670501

1467/RK2

spare filler for item 1467



1467/RK2

1 014670502

1467LF

electric instrument for brake fluid replacement
With "pulsating effect"



"Pulsating effect"

- Automatically stops when tank is empty, thereby preventing air from being let in
 - Maximum tank volume: 20 l
 - Operating pressure: 0.4+3.5 bar
 - Power supply: 230V
- Supplied with:
- Brake oil recovery tank
 - 1 universal cap + 1 standard cap E20

1467LF

1 014670100

1467LF/RC

vessel with recovery tube for item 1467LF



1467LF RC

1 014670125

1468N

valve depressors for disc removal

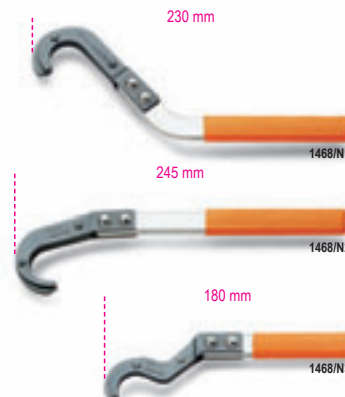

1468N/1

1 014680011

1468N/2

1 014680012

1468N/3

1 014680013

 **Beta**

1470

drum brake spring pliers



L mm		
210	1	014700001
330	1	014700002
540	1	014700010

1470FT

drum brake shoe spring clamp pliers

40° angled noses
Easy access to awkward spaces

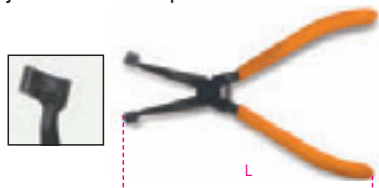

L mm		
184	1	014700000

1471

drum brake spring pliers



L mm		
330	1	014710001

1471A

handbrake wire pliers



A max mm	B mm		
45	5	2	014710010

1471M/C22

pneumatic tool for pushing back and rotating right and left disc brake pistons with accessories



1471M/C22	1	014710101
-----------	---	-----------

350x310x85 mm - 3,5 kg

1471M/50

pneumatic tool for pushing back and rotating right and left disc brake pistons with accessories

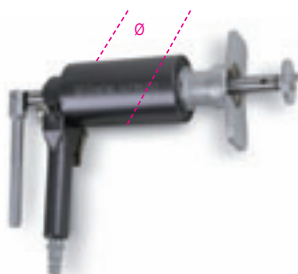

Ø mm	Kg	Bar		
50	150	5÷8	1	014710069

1471M/P

worn pad and TRW-Mégane caliper adapters



1471M/P	1	014710080
---------	---	-----------

1471M/W50

VW Passat handbrake adapter (≥ 2005)

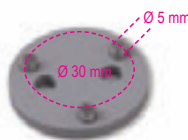

1471M/W50	1	014710079
-----------	---	-----------

1471PN/B1

Ford handbrake adapter

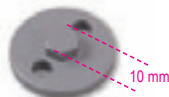

1471PN/B1	1	014710081
-----------	---	-----------

1471PN/B2

Daily handbrake adapter



1471PN/B2	1	014710082
-----------	---	-----------

1471PN/B3

BMW handbrake adapter



1471PN/B3	1	014710083
-----------	---	-----------

1471PN/B4

BMW handbrake adapter

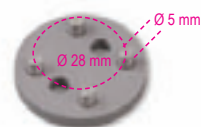

1471PN/B4	1	014710084
-----------	---	-----------

1471PN/B5

Mini/ BMW handbrake adapter



1471PN/B5	1	014710085
-----------	---	-----------

1471CF

pentagon hand sockets for brake caliper nuts



mm		
14	1	014710314
19	1	014710319

1471CM

pentagon socket driver for brake caliper screws



mm		
10	1	014710360

1471CM/E11

hexagon socket driver, 11 mm,
for Mercedes ML brake caliper screws (series
166)



mm	Ø mm	L mm	L1 mm	1	014710361
11	24	75	15,5		

1471D2

tool for pushing back front disc brake pistons,
with closed callipers

Two pairs of plates for working on 2 and 4 piston callipers



mm	1	014710301
10		

250x170x60 mm 1,5 kg

1472

hose clamp pliers



1472	1	014720001

1472AU

automatic hose clamp pliers



Ø mm	L	1	014720100
18÷53			

1472AU/P

automatic hose ring pliers
with extension



Ø mm	L mm	1	014720105
18÷54	630		

1472R/AU

spare tips for pliers 1472AU



1472AU/R	1	014720101

1472AU/RP

spare cable for pliers 1472AU/P



1472AUP/R	1	014720106

1472FC

Clic® collar pliers with swivel heads



1472FC	1	014720090

1472FC/L

Clic® collar pliers with flexible extension



L	1	014720095
630 mm		

1472FCL/RP

spare cable for pliers 1472FC/L



1472FCL/RP	1	014720096

1472FCA

collar removal pliers
with Visa® type rack



1472FCA	1	014720041

1472TM

quick coupler pliers for multijet filters



1472TM	1	014720200

1472VW

hose clamp pliers,
with swivel heads
For Volkswagen and Mercedes cars



1472VW	1	014720051

1473

OETIKER® collar pliers



1473 275	1	014730001

1473A

slotholder pliers for OETIKER® collars



1473A 1 014730010

1473Q

OETIKER® collar pliers with drive

For use with:
• torque wrenches
• ratchets
• male drives



1473Q 1 014730005

1473P

clamp pliers for OETIKER® low-profile collars



1473P 53 1 014730020

1473FN

tool for tightening and cutting strap ties made of stainless steel

For use with Panduit® ties and the like



1473FN 4,7+9,5 1 014730501

1473T

steel collar cutting nippers

allows collars to be cut without risking damaging guards, sleeves etc.



1473T 14 220 1 014730582

1474/C4

kit of 4 tools for removing Volkswagen spark plug coils



1474/C4 1 014740100
290x190x50 mm - 1 kg

1474E/VW

expansion puller for ignition coils, Volkswagen group



1474E/VW 1 014740120

1474L

spark-plug pliers, curved long nose, 15°



1474L 14 20 2 014740010

1474DL

spark-plug pliers, long nose, double layer PVC coated handles



1474DL 1 014740015

1474G

curved long nose pliers for removing glow plug caps



1474G 1 014740200

1475U

combination pliers, bright chrome-plated, double layer PVC coated gun handles

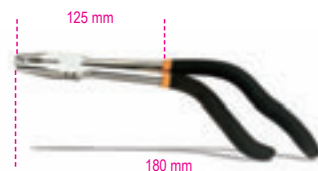

1475U 1 014750010

1476

adjustable self-locking pliers for exhaust pipe cutting

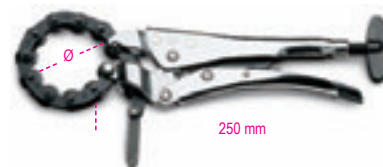

1476 19 75 1 014760001

1476/RC

spare chain for item 1476



1476RC 1 014760010

1476A

pliers for exhaust pipe cutting

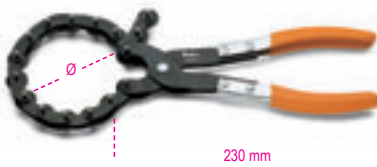

∅ min mm	∅ max mm		
30	95	1	014760005

1476A/RC

spare chain for item 1476A



1476A/RC	1	014760015
----------	---	-----------

1476C/1

exhaust pipe expanders

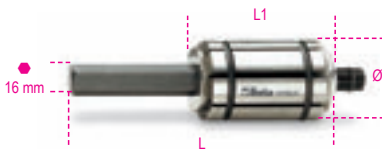

1476C/1	1	014760101
∅ 30=42 mm		
L = 131 mm		
L1 = 51 mm		

1476GT

pliers for removing rubber supports from exhaust pipes



L mm	A Max mm	\pm mm	
280	58	3	1 014760050

1476PSA

exhaust collar pliers with pin, PSA group
Nose shape and automatic rack locking make it possible to work without pulling out pin



L mm	A Max mm	S mm	
309	60	12,2	1 014760060

1476T

wrench for removing/installing turbines on Volkswagen Audi diesel engines



mm			
12	1	014760200	

1477/C10

bent wrench with 9 bits for belt tightening nuts

1 bent wrench with bit drive
4 double bi-hex bits: 12x14 - 13x15 - 16x17 - 18x19 mm
5 bits for Torx(R) head screws: E10 - E12 - E14 - E16 - E18



1477/C10	1	014770310
530x110x55 mm		

1477D

ring wrenches for belt tightening nuts



mm			
13	1	014770113	
15	1	014770115	
16	1	014770116	
17	1	014770117	
19	1	014770119	

1477D/S5

set of 5 ring wrenches for belt tightening nuts



1477D/S5	1	014770200
13-15-16-17-19 mm		
600x200x70 mm - 2,2 kg		

1477K/7

kit with bent reversible ratcheting wrench and bits



- 2 TORX T40-T45 bits
- 1 XZN 10 bit
- 1 hexagon bit, 8 mm
- 3 bi-hex bits, 10-12-13 mm

1477K/7	L mm		
	250	1	014770051

1478

pin removing pliers



1478	1	014780001
------	---	-----------

1478T

plastic pin removable pliers with swivel head and pressure clips

Head can be rotated 90°

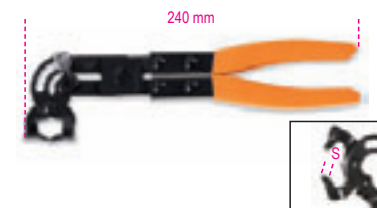

1478T	S mm		
	4,5	1	014780101

1478/3P

plastic pin removal pliers with 3 release points



1478/3P	1	014780151
---------	---	-----------

1479

trim pin remover

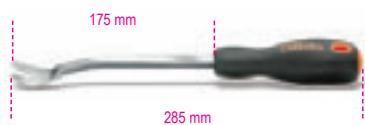

1479 2 014790001

1479/B27

kit of 27 nylon tools for removing pins and working on plastics and seals, hangable



1479/B27 1 014790407

1479L/S2

multipurpose wrecking bars, pair, made of Teflon®



1479L/S2 1 014790510

1479N/S5

kit of 5 nylon trim pin removers



1479N/S5 1 014790251

1479RB/1

straight putty knife scraper



1479RB/1 1 014790315

1479RB/2

bent putty knife scraper



1479RB/2 1 014790320

1479RB/3

flat putty knife scraper



1479RB/3 1 014790310

1479U/13

putty knife scrapers



1479U/13 2 014790010

1479U/32

trim pin remover, stainless steel blade

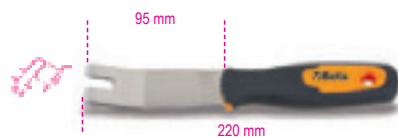

1479U/32 2 014790015

1480

Kit for filling diesel oil filters of cars without electric pumps

• Also for use with tyre inflators

Kit contents:

- GM quick couplings
- Renault, GM, Fiat quick couplings, inside Ø 6 mm
- Renault, GM, Fiat quick couplings, inside Ø 7 mm
- Ford quick couplings
- PSA quick couplings, inside Ø 6 mm
- PSA quick couplings, inside Ø 7 mm
- Ford quick couplings
- 2 cone-shaped adapters for cars without quick couplings



1480 1 014800010

410x320x70 mm

1481/C12

Kit of 6 pairs of hose pliers

Kit contents:

- 2 different pairs of pliers size 1/4"
- 2 different pairs of pliers size 3/8"
- 2 different pairs of pliers size 5/16"
- 3 pairs of rubber caps



1481/C12 1 014810312

370x270x59 mm



1481PL/A

plastic hose pliers

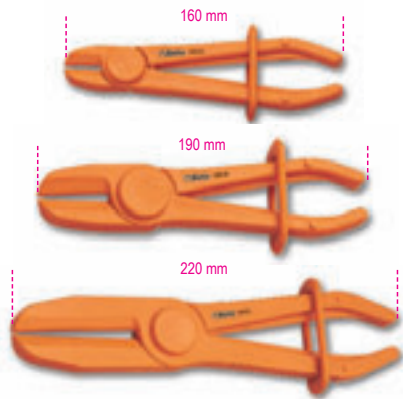

	∅ mm		
1481PL/A	8÷15	3	014810110
1481PL/B	15÷25	3	014810120
1481PL/C	25÷45	3	014810130

1481PL/S3

set of 3 plastic hose pliers

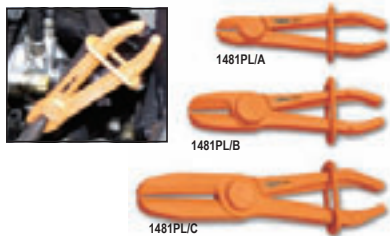

1481PL/S3		1	014810200
1481PL-A	∅ 8÷15 mm		
1481PL-B	∅ 15÷25 mm		
1481PL-C	∅ 25÷45 mm		

1482

adjustable self-locking wrench for tank floating ring nuts



∅ mm			
89÷170		1	014820001

1482A/1

3-leg wrench for floating ring nuts, tank with aluminium ring nut

For operating on aluminium ring nut installed on Fiat, Volkswagen, Opel, Chevrolet, Mercedes and BMW cars since 2011



∅ mm			
185		1	014820005

1482A/2

wrench for tank floating ring nuts, 12 sectors

For operating on ring nut with no side slots installed on Fiat and Ford cars and vans



∅ mm			
132		1	014820006

1482A/3

wrench for tank floating ring nuts, PSA group

So designed as to make it possible to operate on decentralized axis by removing ring nut, without damaging delicate fuel line



∅ mm			
157		1	014820007

1482A/4

wrench for tank floating ring nuts, 5 teeth

for use on FCA group cars, including Freemont, 500L, 500X, Renegade



∅ mm			
145		1	014820014

1482A/5

wrench for tank floating ring nuts, 22 sectors

for use on plastic ring nuts in VAG group cars



∅ mm			
180		1	014820015

1482/8 - 1482/10

quick coupler pliers for fuel pipes

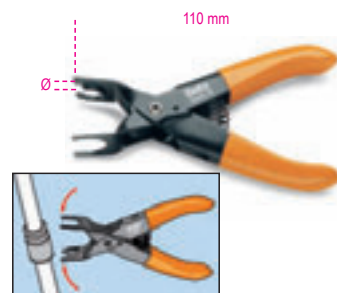

∅ mm			
1482/8	8	2	014820008
1482/10	10	2	014820010

1482B

quick coupler pliers for fuel pipes



1482B		1	014820021

1482C

wedges (2 pairs) for releasing diesel fuel filter fittings, Fiat, Volkswagen, Jeep, Chrysler and Volvo groups

Quick filter replacement without irreparably damaging fittings



1482C		1	014820022

Beta

1483K/12

kit for removing valves from air-conditioning system with set of five-star head bits

Kit contents:

- 2 female octagon sockets, Ø 12 and 15 mm, for high-pressure valves
- 2 male open end sockets, section 2.2 and 3.2 mm, for throttle valves
- 1 set of five-star head bits: PT10, PT15, PT20, PT25, PT27, PT30, PT40



1483K/12 1 014830012

120x80x35 mm

1483KV-PT/S7

set of five-star head bits

Included sizes:

PT10 - PT15 - PT20 - PT25 - PT27 - PT30 - PT40



1483KV PT/S7 1 014830117

1483K/22

kit for separating couplers on air-conditioning, fuel supply and lubrication systems



1483K/22 1 014830022

300x230x55 mm - 1 kg

1484

set of 2 tools for removing and installing stretch belts

Allows stretch belt to be quickly removed and correctly installed, without risking damaging it



1484 1 014840010

1485BP

half-moon tool for locking toothed pulleys

can be adjusted through swivel handle, tightens and locks pulley from outside, preventing neighbouring sensors from getting damaged



A Max mm 130 1 014850000

1485/KIT

kit for controlling cam belt tension



1485/KIT 1 014850100

230x140x75 mm - 580 g

1485MJ

camshaft locking tool, for 1.3 16V Multijet engines

2 3-form heads for working on all 1.3 16V Multijet engines of FCA, Opel, Ford and Suzuki group vehicles



L mm 500 1 014850150

1485R

universal tool for rotating camshaft pulleys made from forged steel with 2 pairs of tips



Ø mm 30-120 Ø1 mm 10 - 17 L mm 500 1 014850025

1485R/P10

pairs of inserts



1485R/P10 1 014850035

1485R/P17

pairs of inserts



1485R/P17 1 014850038

1485VAG

tools for pre-loading timing belt bearings

• 3-position swivel head



	L mm	P mm	
1485VAG/12,5	190	12,5	1 014850062
1485VAG/21,5	195	21,5	1 014850071

Beta

1486/10

wrench for natural gas cylinder valves

- VW group cars since 2008
- Panda from 2004 to 2012
- Grande Punto from 2005 to 2012
- Ducato since 2010
- new Doblò and Combo
- Cubo and Fiorino



○ 36 mm

1486/10



1 014860110

1486/20

wrench for natural gas cylinder valves

- Multipla
- Ducato 1st and 2nd series until 2010
- Berlingo and Ranch
- C3 with iron cylinders
- Punto from 1999 to 2010
- Doblò 1st series
- Daily and Iveco group
- Dr5



○ 36 mm

1486/20



1 014860120

1486/30

wrench for natural gas cylinder valves

- Zafira 2nd series
- Combo 1st series



○ 36 mm

1486/30



1 014860130

1486/40

wrench for natural gas cylinder valves

- Touran 1st series

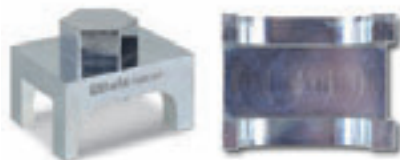

○ 36 mm

1486/40



1 014860140

1486/50

wrench for natural gas cylinder valves

- Panda since 2012
- New Ypsilon



○ 36 mm

1486/50



1 014860150

1486/60

wrench for natural gas cylinder valves

- C4 Picasso
- BRC systems



○ 36 mm

1486/60



1 014860160

1486/70

wrenches for natural gas cylinder valves, pair

- C3 with composite cylinders



○ 36 mm

1486/70



1 014860170

1486/80

wrench for natural gas cylinder valves

- B-Class
- Zafira 3rd series

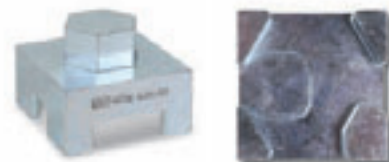

○ 36 mm

1486/80



1 014860180

1486/90

wrench for natural gas cylinder valves

- Zafira 1st series
- Kangoo 1st series
- Sprinter

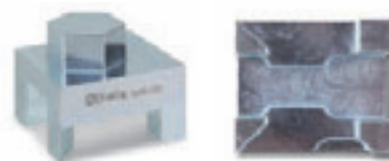

○ 36 mm

1486/90



1 014860190

1488 - 1488L

oil-filter wrench with double chain



	∅ mm	
1488	60÷110	1 014880001
1488L	60÷160	1 014880050

1488/1

oil-filter wrench with thin double chain



	∅ mm	
1488/1	60÷110	1 014880010

1488R...

spare chain



1488RC	1488	1 014880101
1488R/L	1488/L	1 014880150
1488RC/1	1488/1	1 014880110

Beta

1489/31T

alternator pulley free wheel wrench



T50 15 31 1 014890016

1489/33

alternator pulley free wheel wrench



1489/33 33 3 014890010

1489/33P

alternator pulley free wheel wrench, for new Bosch FIAT Grande Punto alternators



M 10 15 31 1 014890015

1489/E

alternator pulley free wheel wrench

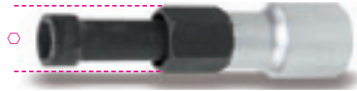

mm 10 mm 15 1 014890025

1489R

alternator pulley free wheel wrench



1489/R 1 014890020

1489/Y

alternator pulley free wheel wrench, for Nippondenso alternators



mm 32 3 014890040

1489/C14

assortment of 14 tools for free alternator pulleys



1489/C14 1 014890100

- 867PE 8 mm
- 867PE/L 8 mm
- 867XZN/L M10
- 867TX/L T50
- 867/2 □1/2"
- 920B 10 mm
- 1489/33
- 12" 1489/33P M10
- 1489R
- 1489/Y
- 1489/31T T50
- 1489/E 10 mm
- 188 10 mm
- 188 15 mm

420x250x45 mm - 1,9 kg

1490

strap wrenches for oil filters

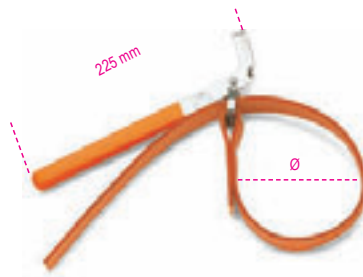

mm max 1490/1 160 1 014900001
1490/2 240 1 014900002

1490/R1 - 1490/R2

spare fabric straps for item 1490



mm 1490R/1 160 1 014900101
1490R/2 240 1 014900102

1491

adjustable oil filter wrench



mm 65-110 2 014910001

1491R

spare metal band for item 1491



1491R 10 014910010

1491C

adjustable oil filter pliers



mm L 60-100 300 1 014910030

1492/1 - 1492/2

adjustable oil filter wrenches



mm 1492/1 60-80 1 014920001
1492/2 80-110 1 014920002

1492T

drier filter wrenches



mm H 1492T 40 125-145 40 1 014920540
1492T 75 120-140 75 1 014920575

1493B

bi-hex wrenches
for hard-to-reach oil filter cartridges

38"



mm	$\frac{1}{4}$ "		
24	8	1	014930524
27	8	1	014930527
32	8	1	014930532
36	8	1	014930536
38	8	1	014930538

1493B/S5

set of 5 bi-hex wrenches
for hard-to-reach oil filter cartridges

sizes:
24-27-32-36-38 mm

38"



1493B/S5 1 014930599

1493

oil filter wrench

12"



Ø mm	N		
65	14	1	014930200
68	14	1	014930206
73	14	1	014930208
74	14	1	014930209
74	15	1	014930210
75-77	15	1	014930212
76	8	1	014930214
76	14	1	014930218
76-74	15	1	014930220
78	15	1	014930224
80	15	1	014930226
82-80	15	1	014930228
86	16	1	014930230
90	15	1	014930234
92	10	1	014930236
93	15	1	014930238
95	15	1	014930244
100	15	1	014930248
106	15	1	014930250
108	15	1	014930252
135	18	1	014930256

1493/PF

Purflux® oil-filter wrenches

12"



Ø mm	N		
66	6	1	014930202
76	12	1	014930216
76	30	1	014930222
86	18	1	014930232
93	36	1	014930240
93	45	1	014930242
96	9	1	014930070
96	18	1	014930246
108	18	1	014930254

1493/C30

set of 28 oil filter wrenches

12"



Sizes included in kit (Ø mm / n°. of sides)
1493:
65/14 - 67/14 - 68/14 - 73/14 - 74/15
76/15 - 75.77/15 - 76/14 - 76/8 - 78/15 - 80/15
82/15 - 86/16 - 90/15 - 92/10 - 93/15 - 95/15
100/15 - 106/15 - 108/15

1493PF (Purflux)
66/6 - 76/12 - 76/30 - 86/18
93/36 - 93/45 - 96/18 - 108/18

- Includes 1 adjustable oil filter wrench
Ø 65÷120 mm

1493/C30 1 014930000

530x400x110 mm - 4 kg

1493AL

oil filter wrenches

N= number of sides

38"

12"



Ø mm	N		
64	14	27	1 014930310
66,5	14	27	1 014930315
74	14	27	1 014930320
79	15	27	1 014930325
84	14	27	1 014930330
87	16	27	1 014930335
92	15	27	1 014930340
94,5	15	27	1 014930345
100,5	15	27	1 014930350

1493AL 4S

oil filter wrenches
for Asian cars
4-hook profile

38"

38"

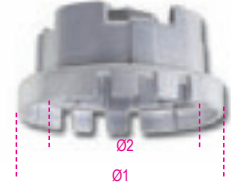

Ø1 mm	Ø2 mm		
70	64,5	27	1 014930304
80	64,5	27	1 014930305

1493AL CF

hexagon socket wrenches
for oil filter cartridges

12"



Ø mm	H mm		
24	34	27	1 014930424
27	34	27	1 014930427
30	34	27	1 014930430
32,5	34	27	1 014930432
36	34	27	1 014930436
38	34	27	1 014930438

1493/C19

set of 18 oil filter wrenches,
particularly suitable for Asian cars

Ø mm	N°. of sides
63-64	14
66,5	14
74	14
79	15
84	14
87	16
92	15
94,5	15
100,5	15

64,5 14 hook wrench for Toyota cars
64,5 14 hook wrench for Lexus cars

6 hexagon sockets, sizes 24-27-30-32,5-36-38 mm, for filter cartridges

Kit includes 1 universal adjustable wrench Ø 58÷93 mm

12"

38"



1493/C19 1 014930019

490x450x60 mm - 4 kg

1493FF

wrench for removing/installing plastic seats of Ford Peugeot Citroën oil filters
engines: TDCi-HDi

Allows plastic seat to be correctly tightened at 25 Nm by means of a torque wrench



1493/S-U

self-adjusting oil filter wrench with 3 arms, for right and left hand tightening

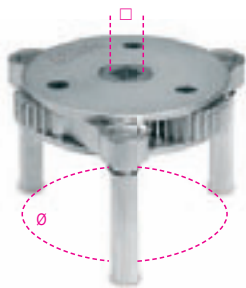

	mm	mm		
1493/S	3/8-1/2	80-115	1	014930074
1493/U	1/2	105-165	1	014930076

1493T

self-adjusting oil filter wrench with three arms, for left-hand tightening



mm		
60÷120	1	014930075

1493J

wrench for MultiJet

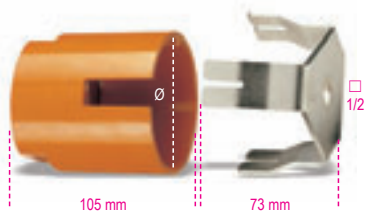

mm		
90	1	014930080

1493Z

self-locking oil filter wrenches, left hand



	mm		
1493Z/1	60÷80	1	014930090
1493Z/2	80÷100	1	014930095
1493Z/3	100÷125	1	014930100

1494

square oil drain plug socket



1494E

male hexagon oil drain plug sockets

mm		
8	1	014940208
9	1	014940209
10	1	014940210
11	1	014940211
12	1	014940212
14	1	014940214
17	1	014940217

1494Q

male square oil drain plug sockets

mm		
8	1	014940258
9,5	1	014940259
12	1	014940262
13	1	014940263

1494T

male triangular oil drain plug socket

mm		
9,5	1	014940289

1494XZN

male oil drain plug socket with XZN® profile



1494VW

special socket for plastic oil drain plugs, Volkswagen engines

Allows plastic plug to be removed and installed from oil sump.
Specially designed for Volkswagen cars with TFSI and TDI engines



1494VW	1	014940305
--------	---	-----------

1494/C14A

assortment of 14 oil change tools



1494/C14A	1	014940150
-----------	---	-----------

- 1494E 8-9-10-11-12-14-17
- 1494Q 8-9,5(3/8")-12-13
- 1494 10
- △ 1494T 9,5(3/8")
- 1494XZN M16

380x305x40 mm - 1,7 kg

1494M

tool for hexagon oil drain plugs, magnetic, flexible

Allows plug to be unscrewed without risking getting burnt or dirty

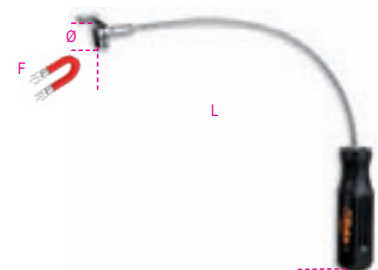

L	F	Ø	
mm	kg	mm	
293	2,5	19	1 014940401

1495/C6

assortment of tools for repairing oil sump threads



• Damaged thread is removed by screw tap and enlarged by one size

• Allows repairs and avoids replacing oil sump

- Contents:
- 1 screw tap M13x1.25 + 6 screws + 12 washers
 - 1 screw tap M13x1.5 + 6 screws + 12 washers
 - 1 screw tap M15x1.5 + 6 screws + 12 washers
 - 1 screw tap M17x1.5 + 6 screws + 12 washers
 - 1 screw tap M20x1.5 + 6 screws + 12 washers
 - 1 screw tap M22x1.5 + 6 screws + 12 washers

1495/C6 1 014950500

420x185x60 mm - 2,1 kg

1495M

screw tap for oil drain plug threads



M	
13x1,25	1 014950553
13x1,50	1 014950563
15x1,50	1 014950565
17x1,50	1 014950567
20x1,50	1 014950570
22x1,50	1 014950572

1495T

kit with 6 oil drain plugs and washers



M	
13x1,25	1 014950503
13x1,50	1 014950513
15x1,50	1 014950515
17x1,50	1 014950517
20x1,50	1 014950520
22x1,50	1 014950522

1496/A

oil plug wrench



10 x 10 mm 2 014960001

1496/C

oil plug wrench



8 x 10 mm 3 014960010

1497CEL

tool for removing electrical connectors from VAG group vehicles

allows connectors to be quickly disconnected, without getting damaged.



1497CEL 1 014970170

1497D

relay removal pliers, straight pattern



1497D 15÷50 1 014970150

Beta

1497P

relay removal pliers, bent pattern, 60°



1497P 15÷50 1 014970160

1497/C23

assortment of 23 tools for releasing electrical connectors



1497/C23 1 014970200

440x250x70 mm - 1,7 kg

1497/C94

assortment of 94 car testing connectors for use with main diagnostic tools

- 2 t-taps
- 2 potentiometers
- 2 warning lights
- 2 SRS connectors
- 2 alligator clips
- 2 acicular probes
- 2 prods
- 2 dual banana connectors
- 4 single banana connectors
- 24 flat male terminals 0.6÷6 mm
- 12 round male terminals 1.6÷3.9 mm
- 24 flat female terminals 0.6÷6 mm
- 12 round female terminals 1.6÷3.9 mm



1497/C94 1 014970300

430x390x100 mm - 3 kg

1497RC

t-taps, pair

- cable section: 1.5÷3.5 mm
- voltage: 0÷330V
- max. current: 5A



1497RC 1 014970351

1498

voltage tester

CE

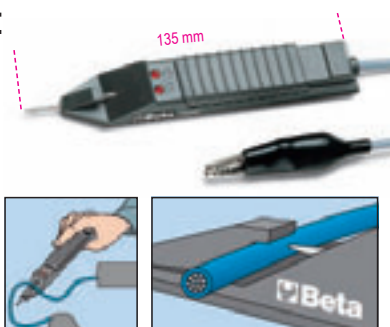

3÷48V 2 014980100

1498CM/12

portable motorcycle emergency starter

- 3 functions in 1:
- starter
 - additional battery for electronic devices (tablets, smartphones etc.)
 - high-brightness LED torch

CE



- Equipment:
- Starting cable with insulated clamps and protection diode
 - Mains battery charger
 - Car battery charger
 - USB cable with charge adapters

TECHNICAL DATA
 Starting current: 200A
 Peak current: 400A
 USB outlet: 5V 2,1A
 Dimensions: 130x50x15 mm
 Weight: approximately 300 g

1498CM/12 1 014980030

1498MN/12

multipurpose portable starter

- Motor vehicle starting with 12-volt battery (diesel and petrol engines up to 2,000 cc)
- Charging of tablets, mobile phones and electronic devices in general
- Multi-use LED torch



STANDARD ACCESSORIES

- lithium-cobalt battery
- starting cables with insulated clamps and device protecting against polarity reversal and short circuits
- USB outlet for charging electronic devices
- digital display and battery charge indicator
- USB cable with charge adapters
- mains and car power supplier

TECHNICAL DATA
 Pickup current: 600A
 Battery type: LiCoO2
 Starting output: 12 volts

1498MN/12 1 014980000

1498MN/12-C

booster cable with clamps for item 1498MN/12



1498MN/12-C 1 014980005

1498LT/12

portable high-performance starter, ultralightweight

CE



- The microprocessor provides full protection against:
- polarity reversal
 - short circuits
 - incorrect voltage
 - overloads
 - underdischarge
 - overcharge
 - overtemperature

TECHNICAL DATA

Operating voltage: 12 V
 Continuous amperage: 800 A
 Maximum pickup amperage: 2000 A
 Peak amperage: 4000 A
 Cable length: 500 mm
 Battery type: 4-cell LifePo4
 Memory saving function: YES
 Dimensions: 260 x 135 x 72 mm
 Net weight: 2.5 kg
 Complete with charging power supply 12 V 1.3A

1498LT/12 1 014980012

1498LT/12-SF

wall fixing bracket for starter 1498LT/12



1498LT/12-SF 1 014980013

1498/12

Portable car starter, 12V

CE



- TECHNICAL DATA:
- Pickup current: 2200A
 - Shoulder strap included
 - Sealed lead acid battery, solid electrolyte (AGM) type

1498/12 1 014980480

13 kg



1498/24

portable car and commercial vehicle starter, 12-24V



TECHNICAL DATA:

- Pickup current: 4200A (12V) - 2100A (24V)
- Shoulder strap included
- Sealed lead acid battery, solid electrolyte (AGM) type

1498/24 1 014980490

17 kg

1498B12/R02

12V spare battery for starters 12-24V



1498B/12-R02 1 014980502

1498C/24

wheeled starter, 24V



- Wheeled frame for easier movements and minimized effort
- Outstanding performance for numerous starts, including particularly demanding ones
- Electronic battery charger included
- LED and sound alarms in case of polarity reversal
- Protection against voltage peaks
- Battery charge indicator
- Solid electrolyte lead-acid battery (AGM)

Continuous amperage	1700 A
Operating voltage	24 V
Pickup amperage	4000 A
Cable length	2000 mm
Cable section	70 mm
Charging voltage	230 V
Automatic battery charger	24 V - 10 A

1498C/24 1 014980244

1498/2A

electronic motorcycle battery charger, 12V

allows charging of all Pb Wet, Agm, Gel, Mf and Vrla battery types and LiFePo4 lithium batteries



- Two different types of charge, for lithium and lead acid batteries respectively
- Automatic multi-stage charge cycle
- Reverse polarity and short-circuit protection
- IP65 degree of protection
- Complete with cable with clamps and cable with eyelets
- Power supply voltage: 220-240V

TECHNICAL DATA

- Charging current: 1A
- Charging capacity: 2Ah-40Ah
- Frequency: 50-60 Hz
- Battery voltage: 12V
- Dimensions: 180x80x40 mm
- Weight: 0.5 kg

1498/2A 1 014980102

1498/4A

Electronic car/motorcycle battery charger, 6-12 V



- Protected against polarity reversal and short circuits
- Automatic 6 V or 12 V selection
- Automatic battery type selection
- Digital backlit display
- Pull-back fixing hook

TECHNICAL DATA

- Power supply voltage: 220V-240V
- Frequency: 50-60 Hz
- Rated current (min-max): 1-4 Amp
- Battery voltage: 6V/12V
- Battery capacity: 4Ah-80Ah
- Charging time: 12 hours
- Degree of protection: IP65

1498/4A 1 014980104

1498/8A

Electronic car / commercial vehicle battery charger, 12 V



- Slow and quick charge (2A-8A)
- Flat battery recovery function
- Power supply function 13.8V-5A
- Protected against polarity reversal and short circuits
- Manual battery type selection
- Digital backlit display
- Pull-back fixing hook

TECHNICAL DATA

- Power supply voltage: 220V - 240V
- Frequency: 50-60 Hz
- Rated current (min-max): 2-8 Amp
- Battery voltage: 12V
- Battery capacity: 5Ah-160Ah
- Memory saving feature: 13.8V - 5A
- Degree of protection: IP65

1498/8A 1 014980108

1498/40A

multipurpose battery charger / starter, 12-24V wheeled



- 3 programmed charging cycles and 1 manual cycle
- electronic adjusting potentiometer
- specific WET-SPIRAL/GEL-AGM charging cycles
- electronic control and protection system
- 10-stage charging process
- battery desulfurization and recovery function
- supply function
- dual voltage, 12-24V
- also suitable for Start&Stop batteries
- professional rubber-insulated brass clamps

TECHNICAL DATA

- Power supply: 230V
- Output voltage: 12-24V
- Charging current: 1-40A
- Starting current: 350A max cc
- Charging capacity: 4-450Ah

1498/40A 1 014980140

330x250x792

1498/4A-8A CO

eyelot cable for items 1498/4A and 8A



1498/4A-8A-CO

1 014980114

1498/4A-8A CP

cable with clamps for items 1498/4A and 8A



1498/4A-8A-CP

1 014980118

1498/50A

electronic multipurpose battery charger, 12V

For charging and powering vehicles while reprogramming and self-diagnosing



CE

50A



SPECIFICATIONS

- Max. charging/power supply current: 50 Amp
- charging
- battery recovery
- power supply for ECU diagnostic protocols
- electronic management through microprocessor
- protected against polarity reversal and short circuits

TECHNICAL DATA

Cable length: 3m
 Section: 10 mm²
 Charging capacity: 5-500Ah
 Maintenance capacity: 5-1500Ah
 Voltage: 12V

1498/50A

1 014980050

150x100x250 mm

Beta

1498SM

memory saver, 12 V

prevents data stored by computer on board cars from getting lost during maintenance jobs or battery replacement.



CE



Technical specifications:

- self-supplied
- internal battery Pb 5 Ah
- 12 volts
- professional connection with OBD socket

1498SM

1 014980020

1498TB/12

digital battery tester, 12V

- Allows the following to be tested: battery, alternator and starter
- Fitted with software for printing test from PC
- Backlit display
- Compact, shockproof frame
- 10 language software
- Complete with input for connecting a removable mini printer (optional accessory)



CE

TECHNICAL DATA:

- Applications: 12V battery test - 12V alternator charge test - Starter test
- Operating range: 100-1700 CCA
- Reference standards: CCA,SAE,DIN,EN,IEC,JIS
- Batteries supported: PB, Wet, Gel, Agm, Mf, Vrla, Sli
- Voltmeter: 9V-15V
- Cable length: 180 cm
- Languages: Italian, English, French, German, Spanish, Polish, Romanian, Dutch, Swedish and Finnish
- Accessories included: USB cable and software

1498TB/12

1 014980400

320x270x100 mm

1498ST/TB

mini thermal printer for tester item 1498TB/12

- Mini printer can be directly connected to tester
- Allows test results to be printed



CE

1498ST/TB

1 014980410

1498ST/TB ROT

paper refill for printer 1498ST/TB



1498ST/TB ROT

2 014980411

1498PC

voltage stabilizer, 12-24 V

Protects control units in welding and starting processes



1498PC

1 014980801

Beta

1498TC

digital glow plug tester

- Quick, accurate glow plug testing
- Suitable for all types of glow plugs, 4.4-5-7-8.5-10-11 Volts
- Digital backlight display
- Suitable for steel and ceramic glow plugs
- Short circuit and polarity reversal protection
- Turns off automatically when not in use
- With buzzer
- With SMD LED torch
- Compact, shockproof frame



CE

- Measurement range: 0.00÷25.0Ω
- Tolerance: ± 2%
- Resolution: 0.01
- Led Display: 1.8"
- Operating temperature: 0°C÷50°C
- Power supply: 1 9V battery (not included)

1498TC 1 014980450

1499

sonoscope probe



1499 1 014990001

1505V

windshield and rear window wiper arm remover

Removable perforated brass tip for arm removal, with built-in washer jet

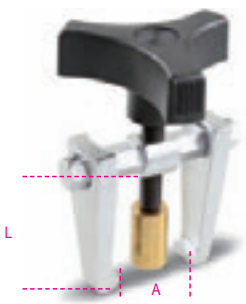

	A Max mm	L mm	
1505V	43	37	1 015050001

1505/C5

windshield wiper removal kit

- 1 two-leg puller, Ø 25÷40 mm
- 4 half-moon tools, Ø 25 mm, Ø 30 mm, Ø 35 mm, Ø 41 mm



mm 12 1 015050300
320x150x60 mm - 1,2 kg

1529

multi-step cone pulley puller

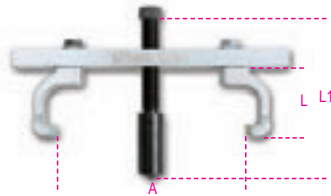

A	L	L1	
min+Max mm	min+Max mm	min+Max mm	
24÷240	60÷95	90÷135	1 015290000

260x210x60 mm - 2,6 kg

1529PI

universal injection pump pulley puller

- Allows fuel injection pump pulley to be quickly and accurately removed.
 - Particularly suitable for Fiat, Ford, Volkswagen, Citroën and Peugeot vehicles.
- Includes 3 pairs of screws for tightening puller to pulley:
M6 x 1.0 x 49 mm
M7 x 1.0 x 75 mm
M8 x 1.25 x 76 mm



1529PI 1 015290051

1530/C5

wheel hub and bearing pulling kit, 3, 4, 5 holes

- Kit contents:
1 universal flange (96÷138 mm)
1 hydraulic screw (12 t)
1 hammer face (2.8 kg), required for hubs without central fixing bolts



1530/C5 1 015300300
760x320x120 mm - 11,5 kg

1547/C6

dummy ball bearing extractors



1547/C6 1 015470006
420x185x60 mm - 3 kg

1547KP

set of 3 pairs of dummy ball terminals



	Ø mm	
1547KP/1	9-11-12,5	1 015470106
1547KP/2	5-6-8	1 015470206

1547P

hexagonal extensions



	L mm	L1 mm	
1547P/1	205	1547/1	1 015470101
1547P/2	102	1547/2	1 015470201

1547PC/2

round extensions, short series



1547PC/2	L mm	42	1547/2	1	015470202
----------	---------	----	--------	---	-----------

1547PL/2

round extensions, long series



1547PL/2	L mm	106	1547/2	1	015470203
----------	---------	-----	--------	---	-----------

1548/C8

internal gearbox bearing puller for FCA and Opel group vehicles

comes with 2 pairs of legs and 4 different supports to adjust to different models manufactured since 2007

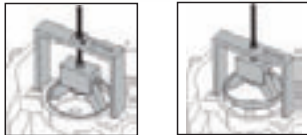

1548/C8

1	015480800
---	-----------

1549

kit for removing and installing double effect shock absorbers

with gas return

allows stem to be kept straightened while springs are being installed



1549

1	015490001
---	-----------

310x270x110 mm - 3 kg

1550U

pneumatic shock absorber removal tool for cars, SUVs and commercial vehicles

CE



78 ÷ 205 mm

x2

1670 mm

610 mm

825 mm

INCREASED POWER: maximum thrust 2 tons (10 bars)
 UPPER UNIVERSAL HOLD SYSTEM: allows all left/right-hand spring diameters to be compressed with one upper adaptable plate.
 ACTIVE SAFETY SYSTEM ON SPRING: safety hook and 3 locking valves allow spring to be properly positioned/seated, maintaining such position throughout compression.
 If spring is not positioned properly, system will stop machine.
 PROTECTIVE "FULL BODY" GRILLE: provides maximum safety and working area coverage
 CONTROL LEVER OPERATION: increased accuracy and sensitivity during compression stage
 WORKING POSITION: working height on rear fork raised up to 875 mm

Supplied with 2 lower forks for diameters 78-205 mm

TECHNICAL DATA

Maximum thrust: 2 tons (10 bars) - 1.6 tons (8 bars) - 1.2 tons (6 bars)

Spring compression stroke: 335 mm

1550U

1	015500010
---	-----------

1550U/MRC-ABE

special forks for item 1550U, specially designed for Mercedes A-B-E Class cars



1550U/MRC-ABE

1	015500031
---	-----------

1550U/MRC-C

special forks for item 1550U, specially designed for Mercedes C class cars



1550U/MRC-C

1	015500032
---	-----------

1550U/S...

lower fork for item 1550U



Ø
mm

1550U/S 130	78÷130 mm	1	015500014
1550U/S 182	105÷182 mm	1	015500015
1550U/S 205	125÷205 mm	1	015500016

1550U/SS187

left-hand fork for item 1550U

Particularly suitable for left-hand springs, e.g. Nissan Qashqai and Renault Koleos



1550U/SS 187

1	015500018
---	-----------

1550U/M

vice for shock absorber removal tool item 1550U

Allows shock absorber stem to be locked



1550U/M

1	015500021
---	-----------

Beta

1555/Q

compressor for MacPherson and equivalent shock absorber springs

Maximum thrust: 1500 kg

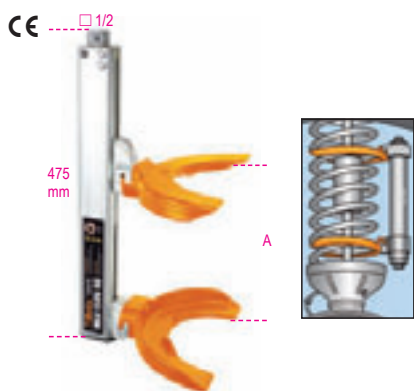

A	Ø
min+Max	min+Max
mm	mm
65+354	80+195

1 015550006

1555/QS

compressor for MacPherson and equivalent shock absorber springs

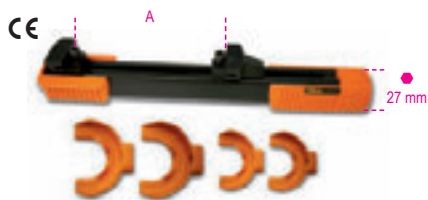

A	Ø
min+Max	min+Max
mm	mm
70+300	90+205

1 015550005

1555S/BMW-RNT

fork for BMW E39, E46 and Renault Mégane II shock absorbers, for items 1555DS and 1555/QS



1555S/BMW-RNT 1 015550303

1555C

telescopic compressor for shock absorber springs with 4 forks and torsion bar



A	Ø	N	t
min+Max	min+Max		
mm	mm		
80+225	90+160	25000	8,5

1 015550202

1556/1A

compressor for shock absorber springs

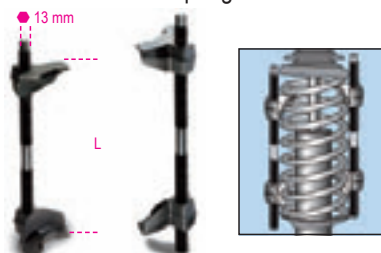

min L	Max
mm	mm
65+320	

1 015560101

1556/2A

compressor for shock absorber springs

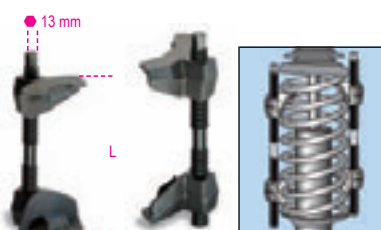

min L	Max
mm	mm
65+200	

1 015560102

1557

impact sockets for truck leaf springs



L	L1
mm	mm
37	28
46	34
56	34

1 015570137
1 015570146
1 015570156

1557V

impact sockets for Volvo leaf springs



27	1 015570299
----	-------------

1557/S3

set of 3 sockets for shock absorber nuts

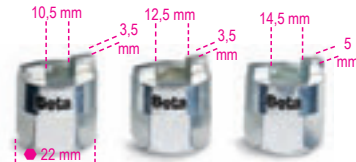

1557/S3 1 015570010

1558/C4

internal and external snap ring tool, screw-operated

square drive allows a high force to be applied in both operating conditions

Supplied tips:
Ø 2.5-3-3.5 mm



1558/C4 5,5 ÷ 77 5,5 ÷ 77 1 015580100
330x220x50 mm - 900 g

1558P

snap ring tips, pair, for item 1558



Ø	
mm	
2,5	1 015580125
3,0	1 015580130
3,5	1 015580135

1559

ball joint puller, light series

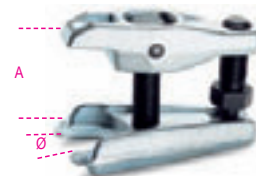

	A Max	Ø	
	mm	mm	
1559/22	50	18+22	1 015590001
1559/36	90	36	1 015590036
1559/45	115	45	1 015590045

Beta

1559V/8T

hydraulic screw for ball joint pullers 1559/36 and 1559/45



Nm	t		
80000	8	1	015590145

1560/1 - 1560/2

ball joint pullers, professional type



	A min+Max mm	Ø mm	
1560/1	12÷50	20	1 015600001
1560/2	60÷85	20	1 015600002

1560A

ball joint puller



1560A	1	015600601
-------	---	-----------

1561/...

ball joint pullers



	L mm	A mm	Ø mm	
1561/1	39	36,6	18	1 015610001
1561/2	47	45,7	25	1 015610002
1561/3	63	62	30	1 015610003
1561/4	75	63	40	1 015610004

1562D

ball joint puller

Supplied with 2 screws for pulling suspension and steering joints



A max mm	Ø mm	L mm	
50	39	26 155	1 015620239

1565/1 - 2 - 3

fork separators for ball joints



	Ø mm	L1 mm	
1565/1	18	65	1 015650001
1565/2	23	65	1 015650002
1565/3	30	88	1 015650003

1566N

tool for removing/installing steering arms



Ø x L mm	Ø mm	
28÷35 x 400	27 12"	1 015660005
35÷45 x 190	27 -	1 015660008
35÷45 x 400	27 12"	1 015660010

1566/G01

homokinetic joint puller

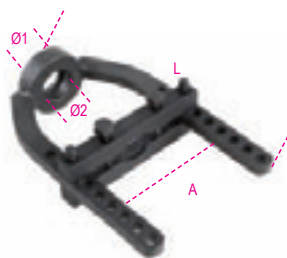

L mm	A mm	Ø1 mm	Ø2 mm	
250	115	29	36	1 015660052

1566P

ribbed axle shaft circlip pliers

Pliers compress circlip, making it easier to fix axle shaft into homokinetic joint



L mm	A Max mm	
280	36	1 015660091

1567

lever for removing wishbone heads and shock absorbers from pillar

Can be used by one operator



A mm	B min+Max mm	
1060	100÷300	1 015670001

1568/C15

chain opening and riveting kit



1568/C15	1	015680015
----------	---	-----------

420x185x60 mm

1568R/CS3

punches for chain openers



1568R/CS3	1	015680503
-----------	---	-----------

1569/A

assortment of tools for removing and installing rear axle silent blocks, driving shaft oil seals and wheel bearings

- Bushings can be used both on vehicle and on hydraulic press
- Kit contents:
 - 4 threaded bars: M10-M12-M14-M16
 - 4 washers
 - bushings for diameters ranging from 44 mm to 82 mm



1569/A	1	015690011
--------	---	-----------

530x415x115 mm

Beta

1569/B

assortment of tools for removing and installing silent blocks, oil seals and wheel bearings

diameter: 14÷32 mm



1569/B

1 015690015

1569/F

tool assortment for removing and inserting Fiat Panda, Fiat 500 and Ford Ka silentblocks



1569/F

1 015690021

1569CP

striking tools for installing conical bearings and oil seals

Quick adjustment



	Ø	L	
	min+Max	mm	
1569CP/50	9,5÷50	130	1 015690750
1569CP/90	18÷90	145	1 015690790

1756C

suction gun, 200 ml, made of polypropylene

- Also suitable for braking system fluid
- Double EPDM gasket
- Operating temperature: +0 - +50 °C
- NOT suitable for fuel



1756C

1 017560502

1756D

suction gun, 1500 ml, made of polypropylene

- Double NBR gasket
- Operating temperature: +0 - +50 °C
- NOT suitable for fuel

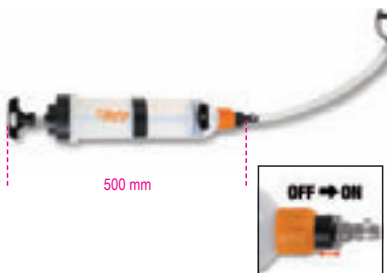

1756D

1 017560515

1756C-2OR

O-rings (pair) for suction guns 1756C

1756C-2OR

1 017560503

1756D-2OR

O-rings (pair) for suction guns 1756D

1756D-2OR

1 017560516

1757

battery fillers



cc	D	
mm	mm	
250	60	4 017570002
500	75	4 017570004
1000	90	2 017570006

1757A

battery filler



cc

2000

1 017570020

1758A

non-return funnel with quick coupling, Ø 38 mm
For Volkswagen group cars



1758A

1 017580010

1758LG

formable, rubber-covered aluminium foil, for canalizing liquids



L	H
mm	mm
365	168

1 017580006

1758M

funnel



1758M

L

350

1 017580000

Beta

1758R

liquid containers

Convenient, removable, flexible spout



	lt		
1758R 3	3	1	017580203
1758R 5	5	1	017580205

1758VT

cylinder head testing kit

Quickly indicates whether expansion tank contains any carbon dioxide.



1758VT		1	017580100
--------	--	---	-----------

600x190x50 mm - 1 kg

1758VT/L

contrast liquid for testing cylinder heads



1758VT/L		1	017580101
----------	--	---	-----------

1759

optical analyzer for coolant, battery, windscreen and AdBlue® fluids
Supplied in a hard case

Automatic temperature compensation
 Battery acid: measurement range:
 1.1÷1.3 kg/l
 Propylene coolant: -25 °C ÷ +50 °C
 Ethylene coolant: -25 °C ÷ +50 °C
 Windscreen fluid: -25 °C ÷ +40 °C
 AdBlue: Urea percent measurement: 30% ÷ 45%



1759		1	017590251
------	--	---	-----------

1759A

antifreeze densimeter, glass body



1759A	L mm 340	1	017590001
-------	----------------	---	-----------

1759B

acid densimeter, glass body



1759B	L mm 280	1	017590005
-------	----------------	---	-----------

1759HD/3

cooling system seal testing and circuit filling tools

• Make it possible to check circuit (pipes, joints, pumps, radiators) for leaks under pressure and quickly fill circuit, avoiding air bubble formation



1759HD/3		1	017590063
----------	--	---	-----------

600x500x140 mm - 6,5 kg

1759HD/RR

cooling system filling tool



1759HD/RR		1	017590064
-----------	--	---	-----------

450x310x110 mm - 2,2 kg

1759HD/TRUCK

truck cooling system testing and sealing tool



1759HD/TRUCK		1	017590065
--------------	--	---	-----------

440x330x100 mm - 3 kg

Beta

1759TT

Kit of 4 pairs of turbo circuit testing caps, for use with tyre inflators



1759TT

1 017590300

400x160x100 mm - 1.8 kg

1760DGT

digital automotive multimeter



CE

195 mm

92 mm



TECHNICAL DATA

RPM (tachometer):
For 2 and 4 cylinder engines
RPM4 600 - 4000 RPM
RPM4 600 - 12000 RPM (x10 RPM)
RPM2/DIS 300 - 4000 RPM
RPM2/DIS 300 - 6000 RPM (x10 RPM)
Dwell angle: 4-8 CYL
DC voltage: 400mV-4/40/400/1000V
AC voltage: 4/40/400/700V
DC current: 40/400mA-4/20A
AC current: 40/400mA-4/20A
Resistance: 400Ω-4/40/400kΩ-4/40MΩ
Capacity: 40/400nF-4/40/100μF
Frequency: 5/50/500Hz-50/500-10MHz
Duty cycle: 0.1% - 99.9%
Pulse amplitude: 1 - 10ms
Diode test: Test current 0.3mA
Continuity: <150Ω - Test current <0.3mA
Display: High-contrast, backlit 4-digit LCD
Overvoltage: Category II 1000V
Auto power off: 30 minutes
Power supply: 1 9V battery (included)
Inductive clamp (included)
2 tips (included)
Soft cloth case (included)
Operating manual

1760DGT

1 017600005

1760B

digital multimeter



CE



SPECIFICATIONS

DC voltage: 200 mV-2/20/200/1000V
AC voltage: 2-20/200/700V
DC current: 2/20/200 mA-20 A
AC current: 2/200 mA- 20 A
Resistance: 200Ω - 2/20/200 kΩ - 2/20 MΩ
Capacity: 2/20/200 nF - 2/200 μF
Temperature: -20° + 1000°C/ -4 °F ~ +2000°F
Frequency: 20kHz
Power supply: 1 9V battery (included)

1760B

1 017600012

1760/OHM

Multimeter/megohmmeter for high voltage insulation testing.
TRUE RMS indicator



CE

CAT. IV
600V
CAT. III
1000V



Measuring range	Base accuracy
AC/DC voltage: 50mV - 1000V	±0.06% - ±0.1% rdg
AC/DC current: 0.01μA - 10A	±0.5% - ±1% rdg
Resistance: 0.01Ω - 50MΩ	±0.2% - ±2% rdg
Meg OHM: 0.01 - 5000MΩ	±4% rdg. max current
1mA	
Capacity: 5nF - 10mF	±1.5% - ±3% rdg
Frequency: 50Hz - 100 MHz	±0.02% - ±0.1% rdg
Temperature: -50 °C - +1350 °C	±0.5% rdg
Diode test: 3V dc	
Continuity test: <30 Ω	

1760/OHM

1 017600025

1760PA/80

AC/DC amperometric clamp, 80A

Designed to measure low current leakage or absorption values on vehicles



CE

- Range: 1mA-80A AC/DC
- Torch function with white LED
- Backlit LCD display
- Zero setting function
- Hold function
- Auto power off
- Power supply: 2 1.5V AAA-type batteries

1760PA/80

1 017600002

1760PA/AC-DC

amperometric clamp and digital multimeter

A: AC/DC
V: AC/DC

CE



A: AC/DC
V: AC/DC

SPECIFICATIONS

DC voltage: 0.1mV ÷ 600V
AC voltage: 0.1mV ÷ 600V
AC current: 0.01A ÷ 1000A
DC current: 0.01A ÷ 1000A
Resistance: 0.1Ω ÷ 40MΩ
Capacity: 0.001nF ÷ 40 μF
Frequency: 0.001kHz ÷ 4kHz
Temperature: -40°C ÷ +1000 °C
-40°F ÷ 1832°F

1760PA/AC-DC

1 017600000



1760/TC2

combination contact/non-contact digital tachometer



TECHNICAL DATA

- For measuring:
 - non-contact rotational speed (rpm)
 - contact rotational (rpm) and linear surface speed (m/min or ft/min).
- 5-digit LCD display.
- Scale:
 - non-contact speed 2.5÷99,999 rpm
 - contact speed 0.5÷19,999 rpm
 - linear surface speed 0.05÷1,999.9 m/min.
- Frequency: 0.8 sec.
- Power supply: 4 1.5V batteries, AA size, or 6V power supply unit (not included).
- Supplied with the following:
 - adaptor for contact tip measurement;
 - male (contact) rubber tip (2 pcs.);
 - female (contact) rubber tip (1 pcs.);
 - linear measurement tape (1 pcs.);
 - reflecting tapes;
 - instruction manual;
 - plastic case.

	L	H	
1760/TC2	mm 230	mm 74	1 017600161

1760R/TC2

set of reflecting tapes for item 1760/TC2



1760R/TC2	1 017600561
-----------	-------------

1760/IR800

digital infrared thermometer with dual laser aiming system



TECHNICAL DATA

- Range: -50 °C to +800 °C / -58 °F to +1472 °F
- Scale selection: °C/°F
- Accuracy: ±1.0% or ±1.0 °C to 20 °C
- Laser power: <1mW
- Response: 150ms
- Emissivity: 0.10-1.0 adjustable
- Distance ratio: (D:S) 20:1
- Operating temperature: 0 °C ÷ 50 °C / 32 °F ÷ 122 °F
- Operating humidity: 10% to 90% RH
- Backlit LCD display
- Data storage function
- Auto power off
- Power supply: 1 9V battery (included)
- Soft cloth case (included)
- Operating manual

1760/IR800	1 017600380
------------	-------------

1763

Car upholstery clip pliers



1763	1 017630001
------	-------------

1763G/S500

500 car upholstery clips



1763G/S500	1 017630105
------------	-------------

1765/C24

cases with 24 tools for pulling out car radios



1765/C24	1 017650001
----------	-------------

1766

double suction lifter

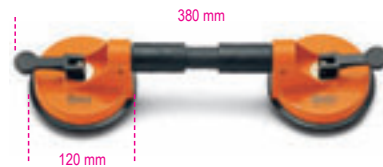

max kg	50	2 017660001
--------	----	-------------

1766A

single suction cup



max kg	30	2 017660005
--------	----	-------------

1766/8

assortment of 8 tools for car glass windows



1766/8	1 017660100
--------	-------------

Beta



Beta

1766ER

window trim removal tool
with handle

Allows window trims to be easily removed,
with no risk of damage





1766ER   1 017660501

1766L

lever for glass windows





1766L   1 017660015

1766LI

lever for inserting car glass window cutting
cable
sharp edges for cutting bonds





1766LI   1 017660016

1766I

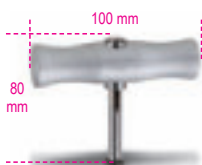
handle for steel cable item 1766G





1766I   2 017660020

1766G

steel cable for car windows

Square section





50 m   1 017660025

1766T

steel cable for glass windows

triangular section



50 m   1 017660026

1767A

telescopic rod

- designed to support bonnets and tailgates with decompressed pistons.
- can be used to keep pedals from moving.





L
mm
640 ÷ 1090   1 017670000

1767PMC

magnetic tool holder, round





1767PMC   1 017670020

1767PMR

magnetic tool holder, rectangular



1767PMR   1 017670010



Beta

1877

exhausted oil drain unit, wheeled, with 90 l tank

- level indicator
- big diameter pan with breakwater grate; capacity: 12 l
- pneumatic tank emptying through 1.8 m pipe
- tool tray

CE



1877

1 018770008

1877A

exhausted oil drain unit / vacuum cleaner, wheeled, with 90 l tank and pre-chamber

- level indicator
- big diameter pan with breakwater grate; capacity: 12 l
- transparent pre-chamber: capacity 9.5 l
- 1.8 m suction pipe
- pneumatic tank emptying through 1.8 m pipe
- tool tray

Standard accessories:

- 1 hard probe, Ø 5x700 mm
- 1 flexible probe, Ø 5x700 mm
- 1 hard probe, Ø 6x600 mm
- 1 flexible probe, Ø 6x700 mm
- 1 flexible probe, Ø 7x700 mm
- 1 flexible probe, Ø 8x700 mm
- adapters for VW, BMW, CITROËN

CE



1877A

1 018770080

1878 3

oil collection tank, for truck hubs
With oil drip catcher



1878 3

lt

3

1 018780003

1878 11

fluid collection tank

- Maximum capacity: 11 l
- Fluid drain plug
- Interior wall for preventing fluid leakage during transportation



1878 11

lt

11

1 018780011

1878 30

fluid collection tank

- Maximum capacity: 30 l
- Splashproof grate
- Fitted with 4 pivoting wheels

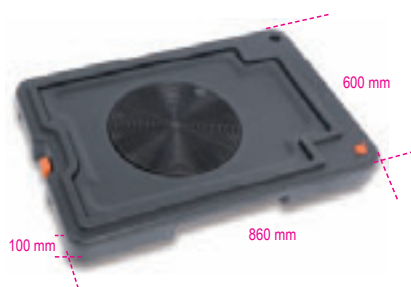

1878 30

lt

30

1 018780030

1879

9.5 l manual/pneumatic operation fluid extractor



1879

1 018790001

1879R/K4

kit of 4 spare tubes for fluid extractor 1879



1879R/K4

1 018790504

1880

manual barrel pump



1880

gr

240

1 018800001

1881

pneumatic barrel pump, ratio 3:1



1881

l/min

14

1 018810001

1882

oil gun with flexible end and automatic drip catcher

- 1/2"
- Maximum delivery rate: 65 l/min
- Maximum operating pressure: 100 bar
- Lockable delivery lever



1882

1 018820010

1883

digital litre counter for oil

- 1/2"
- Shockproof rubber coating
- Battery: 1 CR2 (included)
- Max. delivery rate: 0÷35 l/min (0÷9 gal/min)
- Max. pressure: 50 bar (750 psi)
- Viscosity: 8÷5000 mPas
- Tolerance: ±0.5%

CE



1883

1 018830035

1883NC

male-male nipple, 1/2, for items 1882 and 1883



1883NC

1 018830135

1884

oil filler tool for manual and automatic gearboxes and differentials

Complete with 12 adaptors for direct connection



1884

1 018840010

AT-101	FORD
AT-102	UNIVERSAL (Bmw, Honda, Nissan...)
AT-103	VW-AUDI
AT-104	VW-AUDI-PORSCHE
AT-105	VW-AUDI-MINI COOPER
AT-106	MERCEDES
AT-107	DSG
AT-108	VW-AUDI CVT
AT-109	VOLVO
AT-110	TOYOTA-LEXUS
AT-111	SKODA
AT-112	VW Passat/Tiguan <2007

1884/C12

case of adaptors for item 1884



1884/C12

1 018840100

1889

steel handling and storage base for 2 200-l barrels

- Completely hot painted with epoxy powder
- Easy to carry with a fork lift truck or a transpallet
- Support cannot be placed under any part

CE

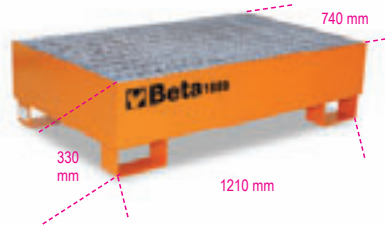

1889

1 018890200

1895 6

ultrasonic cleaning tank, 6 l

with special degas function



CE

- Ultrasonic cleaning relies on fluid heating to effectively clean spare parts and metal pieces in general (injectors, carburetors, valves etc.)
- Digital display for temperature and cleaning time selection
- Two cleaning modes: "soft" and "normal"
- For normal cleaning, just use water at a temperature of 50-60 °C
- For more accurate cleaning, add non-foaming detergent solutions specific for ultrasonic tanks
- Using the degas mode speeds up air release throughout the tank, thereby improving ultrasonic cleaning efficiency.

TECHNICAL DATA
 Tank capacity: 6 l
 Drain tap
 Power: 150 W
 Heating power: 300 W
 Temperature range: 0+80 °C
 Cleaning time range: 0-99 minutes
 Frequency: 40 kHz
 Power supply: 220/230V
 Dimensions: 330x180x310 mm

1895 6

1 018950060

2250-O

heavy duty swivel creeper seat with tray



2250-O

1 022500011

2251-O

heavy duty swivel creeper seat with drawers



2251-O

1 022510011

2252

seat with castors

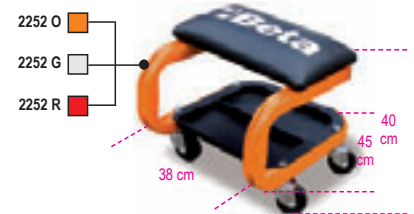

2252-O

1 022520001

2252-G

1 022520002

2252-R

1 022520003

2252KR4

spare seat castors



2252KR4

1 022520900

2254T

kneeling pad

made from non-slip EVA foam



2254T

1 022540047

2258-O

heavy duty creeper with tool chest



2258-O

1 022580011

1927SP-AM

magnetic support for pneumatic impact wrench

- Fitted with two high-powered magnets with protective rubber tops
- Can accommodate 1 1/2" impact wrench, 4 sockets and 1 torque wrench
- Capacity: 10 kg



g
400

1 019270000

1949DGT

digital tyre inflator

- Operating pressure: 0÷11 bar (2.0÷160 psi)
- 4 units of measurement: psi/bar/kgcm2/kpa
- Backlit LCD display
- Reset feature
- Self-power off after 3 min.
- Pressure release button
- Resolution: 0.05 bar
- ABS housing, protective rubber shell on gauge, shockproof, nonslip handle grip
- Power supply: 2 AAA size 1.5V batteries
- Compatible with coupling 1916G 1/4"



1949DGT bar 0÷11 g 500

1 019490020

1949GPE

tyre inflator

- Operating pressure: 0÷11 bars (10÷160 psi)
- Pressure release feature
- Pressure measurement feature
- Gauge coated with schockproof rubber
- 360 degree hose rotation



1949GPE bar 0÷11 g 640

1 019490008

1949GPN

tyre inflator, ABS housing

- CE certified pressure gauge with scale 0.7÷12 bars (graduation: 1/10 bars)
- Two servo-controlled buttons allow accurate, quick tyre inflating (+) and deflating (-)
- Supplied with a calibration certificate
- Fitted with a shockproof, protective shell and an eyelet
- Fitted with a 1/4" GAS threaded coupler
- Swivel air inlet for rubber hose, Ø 7 mm

CE



1949GPN bar 0,7÷12 g 810

1 019490011

1949M

tyre pressure tester



1949M bar 0÷4 psi 5÷60 g 280

1 019490400

2115P L-MQ32

assortment of 32 insulated tools for hybrid cars, in plastic tool box with soft thermoformed tray



2115PL-MQ32

1 021150332

920MQ/55A

89MQ 10-12 mm

850MQ 1/4"

860TX/A10 T7-T8-T9-T10-T15-T20-T25-T27-T30-T40

920MQ/A 8-10-12-13-14-17-19 mm

920MQ/21 125mm

920MQ/22 250mm

1048MQ250 250mm

1150MQ 180mm

1164MQ160 160mm

1272MQ 4.5X80-6X100mm

1274MQ 3X100-4X100-5.5X125

1995MQ/G2 G2

CP15L

3000M/LT

creeper

- PVC lining with upholstered foamed rubber designed for remarkable comfort

ADJUSTABLE HEAD-REST BY PROGRESSIVE AIR SPRING



3000M/LT

g 7,3 kg

1 030000220

3000M/RLS

spare creeper castors



3000M/RLS

1 030000206

3002

creeper and seat

- Steel frame
- PVC lining with upholstery
- Easily convertible into a creeper or a seat

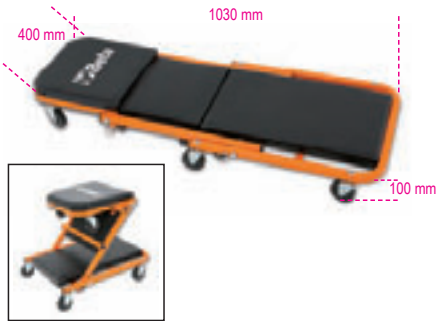

3002

1 030020001

3002/RLS

6 spare wheels for creeper 3002



3002/RLS

1 030020501

3003

creeper
made of shockproof plastic

- Wheel Ø: 76 mm



3003

1 030030001

3003/RLS

6 spare wheels for creeper 3003



3003/RLS

1 030030501

3007

underbody trolley for vehicles
without forecarriage / rear axle

Allows vehicles without

- forecarriage or rear axle to be easily handled while working
- 4 pivoting wheels, including 2 with brakes, suitable for use in painting furnaces
- 2 sliding supports to fit all chassis
- max. capacity: 800 kg

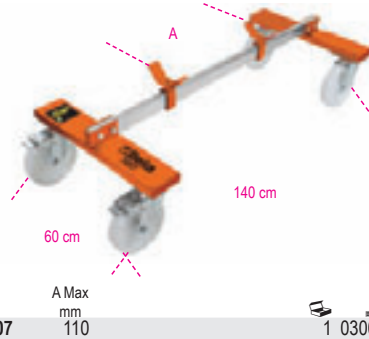

3007

A Max mm
110
1 030070001

3008

jack and positioner
for single and twin truck wheels

- max. capacity: 700 kg
- min. height: 140 mm
- max. height: 660 mm
- distance between rollers: 470÷740 mm
- hydraulic overloading safety device
- front pivoting wheels

CE



3008

1 030080100

3009

wheel lifter

- Maximum lifting capacity: 550 kg
- 4 pivoting rollers
- Roller width: 200 mm
- For wheels up to 240 mm in width

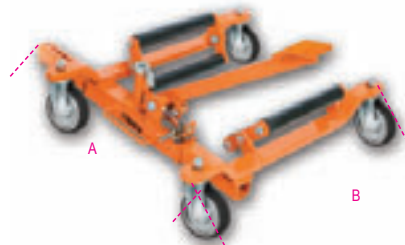

A B
400÷850 mm 600 mm

1 030090001

3009R/GR4

4-wheel groups for trolleys 3009 R/GR4



3009R/GR4

1 030090501

3010/T...

jack stands, pair



C max kg	H min mm	H max mm	H1 mm	L mm	L1 mm
2000	280	425	245	185	165

3010T 2

1 030100002

C max kg	H min mm	H max mm	H1 mm	L mm	L1 mm
3000	285	430	250	180	195

3010T 3

1 030100003

C max kg	H min mm	H max mm	H1 mm	L mm	L1 mm
6000	400	580	340	245	280

3010T 6

1 030100006

C max kg	H min mm	H max mm	H1 mm	L mm	L1 mm
10000	471	735	420	330	290

3010T 10

1 030100010

 Beta

 Beta

3011/T

hydraulic bottle jacks

CE



C max	H min	H Max	L
kg	mm	mm	mm
3500	170	366	86

3011T 3,5 1 030110035

C max	H min	H Max	L
kg	mm	mm	mm
5000	203	467	118

3011T 5 1 030110050

C max	H min	H Max	L
kg	mm	mm	mm
10000	220	484	114

3011T 10 1 030110100

C max	H min	H Max	L
kg	mm	mm	mm
15000	230	497	113

3011T 15 1 030110150

C max	H min	H Max	L
kg	mm	mm	mm
20.000	245	521	115

3011T 20 1 030110200

3012

engine brackets



L	C max		
mm	kg		
1500	500	1	030120010
1800	400	1	030120018

3012C

lower engine bracket

ideal for cars and commercial vehicles

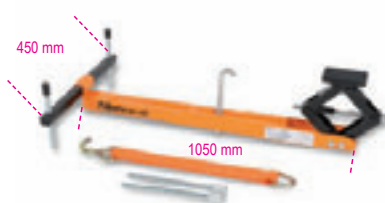

3012C 1 030120255

3012I

lower engine bracket

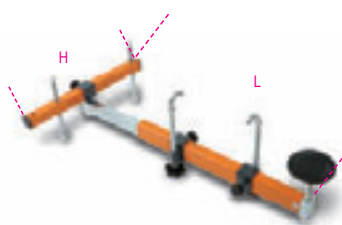

	L	H		
	mm	mm		
3012I	630=960	190	1	030120250

3014

engine stand



3014 1 030140010

3014R/GR5

5 spare wheels for engine stand 3014



3014R/GR5 1 030140501

3014 SAR

folding engine stand

- Easy to fold up, for significantly increased compactness
 - Allows 360° rotation of engine or gear
 - Provides unparalleled safety and stability during jobs
- Maximum capacity: 450 kg



3014SAR 1 030140360

3014SAR/RR

4 spare wheels for engine stand 3014SAR



3014SAR/RR 1 030140370

3014SAR/1

fluid collection tank for item 3014 SAR

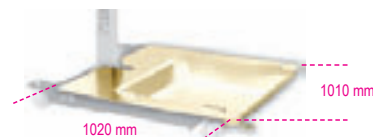

3014SAR/1 1 030140361

1020x1010x11 mm

3014SAR/2

clamp for fixing transmission gear on stand item 3014 SAR



3014SAR/2 1 030140362

3025

folding hydraulic crane with dual effect pump

Maximum capacity: 1 t

CE



3025 3025 1 030250001

3025/RF

2 spare fixed wheels for hydraulic crane 3025



3025/RF 1 030250901

3025/RG

2 spare swivel wheels for hydraulic crane 3025



3025/RG 1 030250902

3025/PF

barrel handling pliers

Maximum capacity: 300 kg

CE



3025/PF A mm B mm 550+640 70 1 030250011

3026 0,3

hydraulic pit and under bridge jack

CE



3026 0,3 1 030260003

3026/R0,3

4 spare swivel wheels for hydraulic jack 3026 0,3



3026/R 0,3 1 030260903

3026 0,5

hydraulic pit and under bridge jack

Maximum capacity: 500 kg

CE



3026 0,5 1 030260005

3026/R0,5

4 spare swivel wheels for hydraulic jack 3026 0,5



3026/R 0,5 1 030260905

3026 1,0

hydraulic pit and under bridge jack

Maximum capacity: 1 t

CE



3026 1,0 1 030260010

3026/S

swivel transmission gear support with reduction bushes for jacks item 3026

Maximum capacity: 500 kg



3026/S 1 030260501

3026/SP

Universal transmission support

Allows one operator to disassemble and reassemble any transmissions of cars, commercial vehicles and off-rodgers quickly and safely.



3026/SP 1 030260505

3027 10

hydraulic bench press with moving piston

Maximum capacity: 10 t

CE



3027 10 1 030270010

90 kg

3027 20

hydraulic press with moving piston

20 t

Maximum capacity: 20 t

CE



3027 20 1 030270020

140 kg

3027 30

hydraulic press with moving piston and hoist

Maximum capacity: 30 t

CE



3027 30 1 030270030
230 kg

3027 50

hydraulic press with moving piston and hoist

Maximum capacity: 50 t

CE



3027 50 1 030270050
350 kg

3027/KP

set of pin punches and plate for press item 3027



3027/KP10	3027 10	1	030270510
3027/KP20	3027 20	1	030270520
3027/KP30	3027 30	1	030270530
3027/KP50	3027 50	1	030270550

3027/KPP50

pedal control for hydraulic press item 3027 20-30-50



3027/KPP50 1 030270555

3030/2T

lowered car jack, 2 t with 6 wheels

- dual front tilting wheels made of plastic material (PTFE)
- car jack can be easily handled on uneven, irregular floors
- maximum capacity: 2 tons

CE



3030/2T 1 030300020
43 kg

3030/2T-R5

front wheel with pin for jack 3030 2T



3030 2T/R5 1 030300505

3030/2T-R6

spare rear wheel for item 3030/2T



3030 2T/R6 1 030300506

3030/2TRP

spare 85-mm rubber plate for item 3030/2T



3030/2TRP 5 030300501

3033/3T

hydraulic jack, 3t long version

- For use on commercial vehicles
- Maximum capacity: 3 t
- Polyamide wheels

CE



3033/3T 1 030330030

3035

tyre trolley

- 2 castors Ø 260 mm
- 2 castors Ø 125 mm
- Maximum carrying capacity: 200 kg
- Forks can be adjusted in 2 positions: first position: maximum opening 880 mm second position: maximum opening 980 mm
- Can be used as a top by locking position horizontally





3035 1 030350100

3040

rear motorcycle stand
adjustable

- Matt black lacquer
- Polyamide slider holder
- 4 thermoplastic rubber wheels





3040  1  030400001

3040A/1

V-shaped sliders, pair
for item 3040





3040A/1  1  030400501

3040A/2

L-shaped sliders, pair, made of rubber
for item 3040





3040A/2  1  030400502



3040A/6-8-10

pawls, pair, made of aluminium
for item 3040A/1





3040A/6  1  030400506

M6x1 mm
Aprilia, Yamaha, Triumph

3040A/8  1  030400508

M8x1.25 mm
Suzuki, Honda, Ducati

3040A/10  1  030400510



M10x1.25 mm
Kawasaki

3041

front motorcycle stand
adjustable

- Matt black lacquer
- Polyamide slider holder
- 4 thermoplastic rubber wheels





3041  1  030410001

3041A/11

roller sliders, pair
for item 3041





3041A/11  1  030410511

3041A/15

cone-shaped sliders, pair
for item 3041





3041A/15  1  030410515

3041T

front motorcycle stand, high, adjustable,
with radial calipers

- Matt black lacquer
- Polyamide slider holder
- 4 thermoplastic rubber wheels





3041T  1  030410011

3041T/17

L-shaped sliders (pair), made of rubber, for
radial calipers
for item 3041T





3041T/17  1  030410517

3042

front stand
for motorcycle steering pin

- Matt black lacquer
- 4 thermoplastic rubber wheels
- Includes a 6-pin kit





3042  1  030420001

3042/K6P

6-pin kit for motorcycle stand item 3042

(already included in item 3042)





3042/K6P  1  030420101

3043

motorcycle stand
with left single arm

- Matt black lacquer
- Polyamide slider holder
- 4 thermoplastic rubber wheels





3043  1  030430001

3043A/41÷47

pin
for item 3043



	∅ mm	 1 
3043A/41 Ducati	21,8	1 030430541
3043A/42 Triumph	27,5	1 030430542
3043A/43 MV - Ducati	42	1 030430543
3043A/44 Ducati 1098	40	1 030430544
3043A/45 Honda	28,6	1 030430545
3043A/46 BMW F800S	30	1 030430546
3043A/47 BMW K,R,S	52,9	1 030430547





3061/2T

air hydraulic jack, 2 tons - 2 stages



- Fitted with:
- high-resistance three-layer diaphragm and internal telescopic guide
 - end-of-stroke stop and overloading safety valve
 - can also be used on auto lifts

TECHNICAL DATA
 capacity: 2 t
 weight: 14 kg
 power supply pressure: 8-10 bar
 height: min. 132 - max. 326 mm

3061/2T 1 030610020

3061/2T-P50

50-mm extension for item 3061/2T



3061/2T P50 1 030610021

3061/2T-P100

100-mm extension for item 3061/2T



3061/2T P100 1 030610022

3063/2,5T

air hydraulic jack, 2.5 tons, wheeled



Particularly suitable for use on cars and commercial vehicles
 Ideal for garages, tyre repairers' and body shops

- FITTED WITH:**
- automatic arm return
 - full-load speed control

TECHNICAL DATA
 capacity: 2.5t
 weight: 75 kg
 power supply pressure: 8-10 bar
 air consumption: 400 l/min

3063/2,5T 1 030630125



3065/40-20T

air hydraulic jack, 40/20 tons

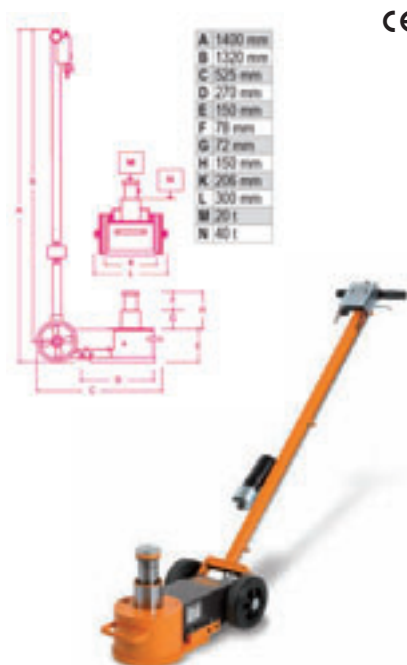

- suitable for use on heavy vehicles
- functional and easy to handle, for transportation on mobile repair shops as well
- automatic piston return
- two descent valves with under load speed control

TECHNICAL DATA
 capacity: 40/20 tons
 weight: 39 kg
 power supply pressure: 8-10 bar
 air consumption: 400 l/min

3065/40 20T 1 030650200

3067/70-13T

air hydraulic jack, 70-43-23-13 t

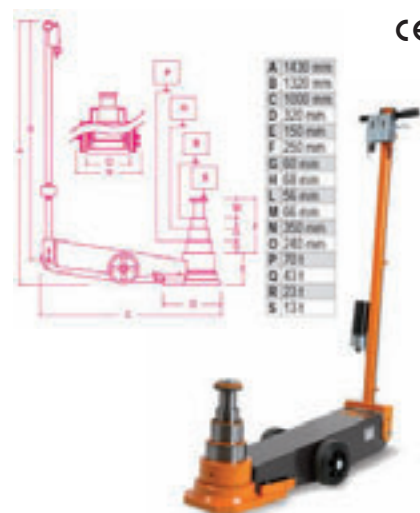

- Long version, suitable for use on lorries, articulated vehicles, buses and coaches, and agricultural machines
- automatic piston return
 - two descent valves with under load speed control

TECHNICAL DATA
 capacity: 70-43-23-13 tons
 weight: 74 kg
 power supply pressure: 8-10 bar
 air consumption: 600 l/min

3067/70 13T 1 030670130

INSULATED TOOLS ⚡ 1000 V

Beta Utensili's insulated tools are meant to guarantee installation and electrical maintenance men's safety. All of the insulated tools make it possible to work on systems up to 1000V on alternating current and up to 1500V on direct current. To provide the highest quality and performance standards and verify fitness and compliance with EN 60900, each tool is subjected to the following stringent tests: handle resistance to slipping and flame propagation, and high voltage test (10000V). For assortments and thermoformed trays, see relevant sections.

All of Beta's insulated tools are built in accordance with the specifications of EN60900 and are approved by the best European certification institutions



Istituto Italiano del Marchio di Qualità - I



Verband der Elektrotechnik
Elektronen Informationstechnik - D

52MQ

single open end wrenches



EN 60900

mm	L mm		
10	110	1	000520110
11	120	1	000520111
12	132	1	000520112
13	140	1	000520113
14	146	1	000520114
15	166	1	000520115
17	168	1	000520117
19	176	1	000520119
22	200	1	000520122
24	225	1	000520124

89MQ

single ring wrenches



EN 60900

mm	L mm		
10	170	1	000890110
11	180	1	000890111
12	190	1	000890112
13	195	1	000890113
14	200	1	000890114
15	210	1	000890115
17	218	1	000890117
19	240	1	000890119
22	255	1	000890122
24	280	1	000890124

110MQ

adjustable wrench with scale



EN 60900

L mm	A max mm		
250	30	1	001100525

606MQ/50

click-type torque wrench with reversible ratchet



EN 60900
UNI EN 26789
ISO 6789

Nm	Kgfm	lbf.ft	A mm	L mm	g
5÷50	0,5÷5	4÷40	90	375	1130

606MQ/50	
1	006060705

850MQ

magnetic bit holder, insulated, with bimaterial handle



IMQ CSV

L mm	L1 mm	D mm		
233	125	12.5	1	008500910

920MQ/A

hexagon sockets



EN 60900

mm	Ø mm	L mm	Ø1 mm		
8	21,5	57	27,5	1	009200238
9	21,5	57	27,5	1	009200239
10	21,5	57	27,5	1	009200240
11	21,5	57	27,5	1	009200241
12	23,0	57	27,5	1	009200242
13	23,0	57	27,5	1	009200243
14	23,0	57	27,5	1	009200244
16	23,0	57	27,5	1	009200246
17	30,0	57	27,5	1	009200247
18	32,0	57	27,5	1	009200248
19	32,2	57	27,5	1	009200249
20	32,0	57	27,5	1	009200250
22	36,0	57	27,5	1	009200252
24	39,0	57	27,5	1	009200254

920MQ/PE

socket drivers for hexagon screws



EN 60900

Ø mm	L mm	L1 mm			
5	28,5	94,5	10,5	1	009200265
6	28,5	94,5	10,5	1	009200266
8	28,5	94,5	10,5	1	009200268
10	28,5	94,5	10,5	1	009200267
12	28,5	94,5	10,5	1	009200269

920MQ/21

1/2" square drive extension bar



EN 60900

L mm	Ø mm		
135	28	1	009200804

920MQ/22

1/2" square drive extension bar



EN 60900

L mm	Ø mm		
264	30	1	009200805

920MQ/T

1/2" square drive, T-handle

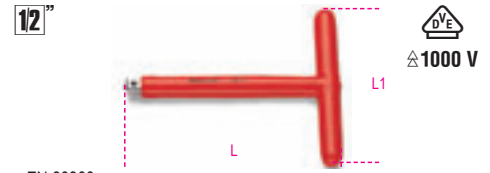

EN 60900

L mm	L1 mm		
200	163	1	009200807

920MQ/55A

1/2" square drive reversible ratchet with socket locking system



EN 60900

L mm	D mm	A mm		
240	50	89	1	009200809

920MQ/C16

9 hexagon sockets, 3 socket drivers for hexagon screws and 4 accessories



EN 60900

920MQ/C16	
1	009200917

- 920MQ/A 8 - 10 - 12 - 13 - 14 - 17 - 19 - 22 - 24 mm
 - 920MQ/PE 5 - 6 - 8 mm
 - 920MQ/21 135 mm
 - 920MQ/22 264 mm
 - 920MQ/55A
 - 920MQ/T
- 420x280x60 mm - 5,2 kg

943MQ

hexagon nut spinners with handles



EN 60900

mm	L mm	L1 mm	D mm		
5,5	233	125	12,2	1	009430235
6	233	125	12,5	1	009430236
7	240	125	14,3	1	009430237
8	240	125	15,3	1	009430238
10	252	125	17,3	1	009430240
13	252	125	21,3	1	009430243

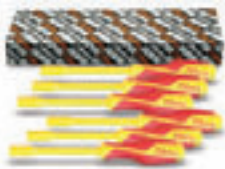

943MQ/S6
5,5-6-7-8-10-13 mm

1 009430250

951MQ

T-handle wrenches with hexagon male ends

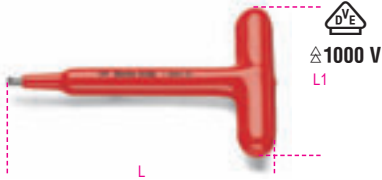

EN 60900

mm	L mm	L1 mm	
4	165	105	1 009510704
5	170	105	1 009510705
6	168	105	1 009510706
8	165	105	1 009510708

993MQ

bent knurled point spring tweezers



EN 60900

L mm	
147	1 009930040

994MQ

straight knurled point spring tweezers



EN 60900

L mm	
145	1 009940040

1010MQ

long round nose pliers



EN 60900

L mm	L1 mm	
160	51,5	1 010100096

1048MQ

slip joint pliers, boxed joint

• Chrome-plated finish

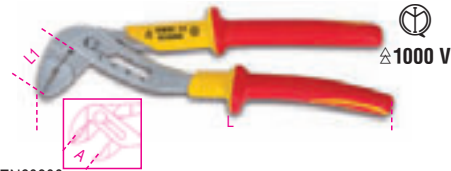

EN60900

L mm	A max mm	L1 mm	
250	48	39	1 010480315

1082MQ

diagonal cutting nippers



EN 60900

L mm	L1 mm	mm	
140	20	1,6	1 010820094
160	22	1,6	1 010820096

1084MQ

heavy duty diagonal cutting nippers



EN 60900

L mm	L1 mm	mm	
200	26	2,0	1 010840100

1088MQ

end cutting nippers



EN 60900

L mm	L1 mm	mm	
160	7	1,6	1 010880096

2115P L-MQ32



2115PL-MQ32

213,257

1128MQ

electrician's scissors, stainless steel blades, with microteeth



IEC60900

L mm	L1 mm	
145	45	1 011280101

1132MQ

cable cutter with insulated handles for copper and aluminium cables



EN 60900

L mm	mm	
230	18	1 011320193

1142MQ

wire stripping pliers



EN 60900

L mm	mm ²	
160	0,5+6	1 011420096

1150MQ

combination pliers, bright chrome-plated

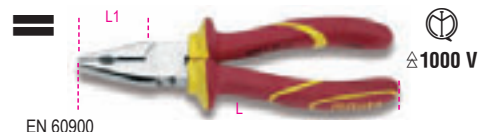

EN 60900

L mm	L1 mm	mm	
160	37	1,6	1 011500096
180	39	1,8	1 011500098
200	43	2,0	1 011500100
220	46	2,0	1 011500102

1162MQ

extra long flat nose pliers



EN 60900

L mm	L1 mm	mm	
160	56	1,6	1 011620096
200	76	1,6	1 011620100

1164MQ

extra-long bent flat nose pliers

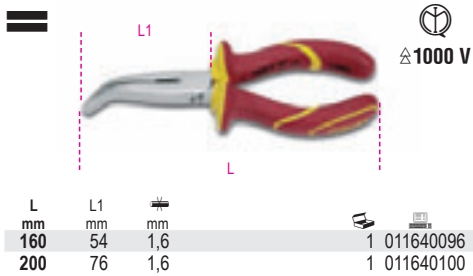

1166MQ

extra long needle nose pliers

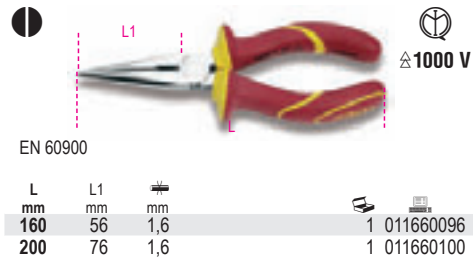

1168MQ

extra long bent needle nose pliers

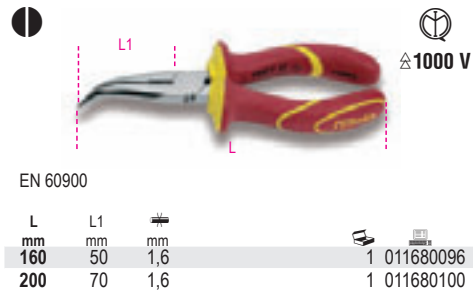

1272MQ

screwdrivers for cross head Phillips® screws

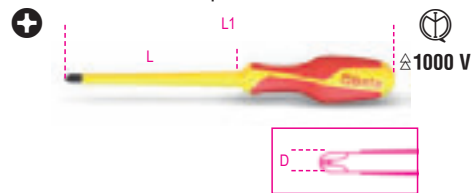

EN 60900

PHxDxL	L1		
0x3x60	160	3	012720703
1x4,5x80	187	3	012720709
2x6x100	218	3	012720718
3x8x150	276	2	012720724
4x10x200	326	2	012720727

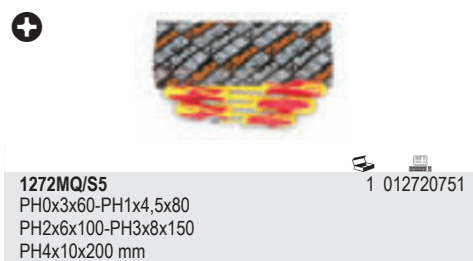

1273MQ/D6

set of 6 screwdrivers



1274MQ	0,5x3x100 -0,8x4x100
1272MQ	1,0x5,5x125 mm
	PH0x3x60 -PH1x4,5x80
	PH2x6x100 mm

1274MQ

screwdrivers for headless slotted screws

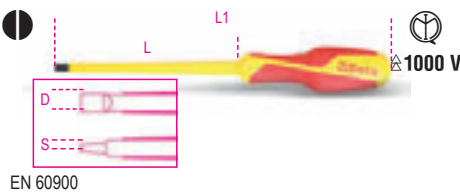

SxDxL	L1		
0,4x2,5x75	175	3	012740700
0,5x3x100	200	3	012740703
0,8x4x100	207	3	012740706
1x5,5x125	232	3	012740709
1,2x6,5x150	268	3	012740712
1,2x8x175	301	2	012740715
1,6x10x200	326	2	012740718



1279MQ

screwdrivers for cross head Pozidriv®-Supadriv® screws

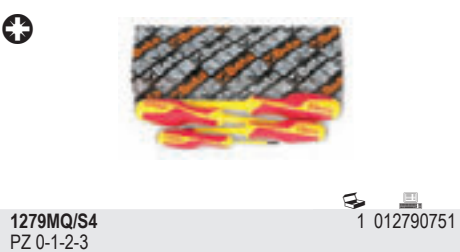
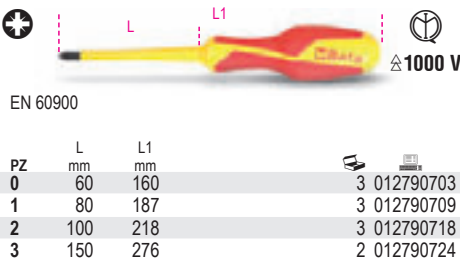

1725MQ

mini-hacksaw frame

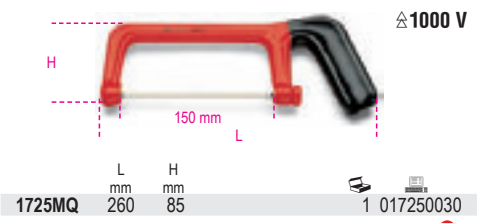

1777MQ/C

cable stripping knife, insulated



1777MQ/U

cable stripping knife, insulated



1777RL/U

4 spare blades for utility knife 1777MQ/U



1995MQ/T

insulating mat

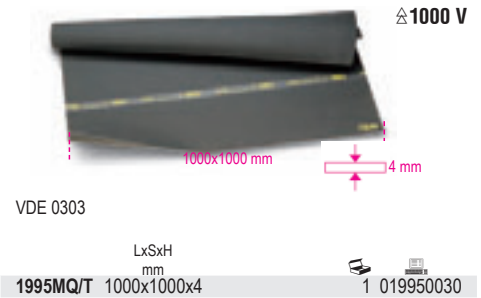

1995MQ/G1 - G2

insulating gloves in latex

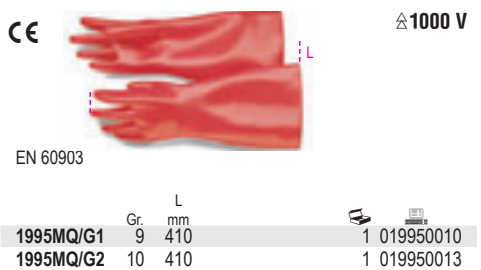



Beta INOX

STAINLESS STEEL



STAINLESS STEEL
+ NO STAINLESS
STEEL = RUST



STAINLESS STEEL
+ STAINLESS
STEEL = NO RUST

THE BETA INOX TOOLS CAN BE
AUTOCLAVE STERILIZED AT 121 °C

The BETA INOX tools can be used in critical environments - that is, in areas where the minimum level of contamination is not permitted. Some examples are:

- Nuclear applications
- Pharmaceutical production - class C
- Offshore applications
- Biotechnological and biomedical laboratories
- Food industry.

The Beta Inox tools avoid improper rust formation.

Whenever any tools other than those made of stainless steel are used on stainless steel screws, nuts or surfaces, a few particles may come off the tools, thereby triggering corrosion. This often results in aesthetic problems and, sometimes, in structural problems as well.

Examples of applications are:

- Shipyards
- Building
- Solar systems
- Car industry.

CHARACTERISTICS

Accurate selection of the materials¹ and the expert quest for the best heat treatment provide the Beta Inox tools with mechanical characteristics which far exceed the standards and are comparable to those of the other Beta tools.

These tools share the same ergonomic properties and design as the other Beta tools, which have been known to, and appreciated by, professional users for over 75 years.

Stainless steel is 100% recyclable, which is also a major plus.

¹ Beta Utensili uses magnetic stainless steel AISI 420

42INOX

combination wrenches
made of stainless steel



mm	L mm		
6x6	95	2	000420306
8x8	116	2	000420308
10x10	137	2	000420310
11x11	148	2	000420311
12x12	158	2	000420312
13x13	169	2	000420313
14x14	180	2	000420314
15x15	190	2	000420315
16x16	201	2	000420316
17x17	212	2	000420317
19x19	233	2	000420319



42INOX/S11	1	000420391
6-8-10-11-12-13-14-15-16-17-19 mm		



42INOX/SC9	1	000420387
8-10-11-12-13-14-15-17-19 mm		
42/SCV9I	1	000420103

42INOX-AS

combination wrenches,
made of stainless steel



mm	L mm		
1/4x1/4	95	1	000420356
5/16x5/16	116	1	000420358
3/8x3/8	137	1	000420360
7/16x7/16	148	1	000420361
1/2x1/2	169	1	000420363
9/16x9/16	180	1	000420364
5/8x5/8	201	1	000420366
11/16x11/16	212	1	000420367
3/4x3/4	233	1	000420369



42INOX-AS/S9
1/4-5/16-3/8-7/16-1/2
9/16-5/8-11/16-3/4

1 000420396

96BPINOX

ball head offset hexagon key wrenches,
made of stainless steel



mm	L mm	L1 mm	g		
2	91	22	4	4	000961441
2,5	91	22	6	4	000961442
3	101	24	11	4	000961443
4	112	29	19	4	000961444
5	131	33	32	4	000961445
6	154	36	51	4	000961446
7	164	40	65	2	000961447
8	175	44	116	2	000961448
10	197	51	189	2	000961450



96BPINOX/B6
2,5-3-4-5-6-8 mm
96BPINOX/B9
2-2,5-3-4-5-
6-7-8-10 mm
96BPINOX/BV

1 000961455
1 000961456
1 000961459

96BPINOX-AS

ball head offset hexagon key wrenches,
made of stainless steel



"	L mm	L1 mm	g		
5/64	91	22	5,5	4	000961989
3/32	91	22	5,3	4	000961990
7/64	101	24	10,5	4	000961991
1/8	101	24	10,7	4	000961992
9/64	112	29	18,7	4	000961993
5/32	112	29	18,7	4	000961994
3/16	131	33	31,5	2	000961995
7/32	154	36	50,0	2	000961996
1/4	164	40	70,0	2	000961997
5/16	175	44	115,0	2	000961998
3/8	197	51	186,5	2	000961999



96BPINOX-AS/B8
5/64-3/32-1/8-5/32-
3/16-7/32-1/4-5/16
96BPINOX/BV

1 000962000
1 000961459

96TINOX

offset hexagon key wrenches,
with high-torque handles,
made of stainless steel

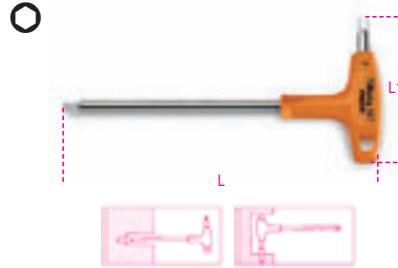

mm	L mm	L1 mm		
2,5	153	55	2	000961935
3	153	55	2	000961936
4	179	70	2	000961938
5	200	84	2	000961940
6	221	95	2	000961941
7	236	106	2	000961942
8	255	117	2	000961943
10	285	132	2	000961944



96TINOX/S5
2,5-3-4-5-6 mm
96TINOX/S8
2,5-3-4-5-
6-7-8-10 mm

1 000961952
1 000961954

96TINOX-AS

offset hexagon key wrenches,
with high torque handles,
made of stainless steel

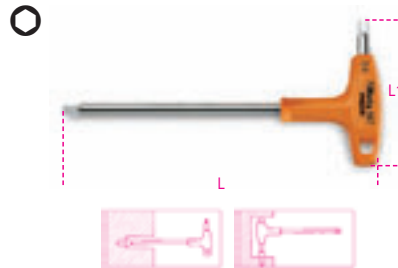

"	L mm	L1 mm	Ø mm		
3/32	153	55	3	2	000961861
7/64	153	55	4	2	000961862
1/8	179	70	4	2	000961863
9/64	179	70	5	2	000961864
5/32	200	84	6	2	000961865
3/16	200	84	6	2	000961866
7/32	221	103	7	2	000961867
1/4	236	106	8	2	000961868
5/16	255	117	10	2	000961869
3/8	285	132	12	2	000961870

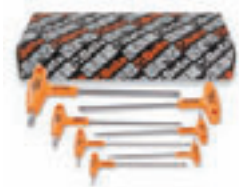

96TINOX-AS/S7
3/32-1/8-5/32-3/16-
7/32-1/4-5/16

1 000961877

1290INOX

screwdrivers for slotted head screws
made of stainless steel

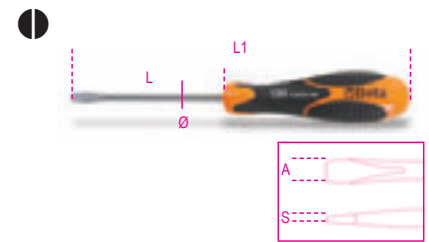

SxAxL mm	L1 mm	Ø mm		
0.4x2.5x50	146	2.5	4	012900403
0.5x3x75	171	3.0	4	012900409
0.8x4x100	196	4.0	4	012900430
1.x5.5x150	259	5.0	4	012900442
1.2x6.5x150	270	6.0	4	012900451

1292INOX

screwdrivers for cross head Phillips® screws,
made of stainless steel



PHxDxL mm	L1 mm		
0x3x60	156	4	012920403
1x4.5x80	189	4	012920409
2x6x100	220	4	012920418

1293INOX/D8

screwdriver set
made of stainless steel



1293INOX/D8			1 012930408
1290INOX	2,5x50-3x75		
1292INOX	4x100-5,5x150-6,5x150 mm		
	PH0x60-PH1x80		
	PH2x100 mm		

C04TSS-7

mobile roller cab with seven drawers, made entirely of stainless steel

Main features:

- Seven drawers (570 x 410 mm) with ball bearing slides;
- 6 drawers, 83 mm high;
- 1 drawer, 170 mm high;
- 4 castors Ø 125 mm
- 2 fixed and 2 steering (two with brakes);
- Front centralized lock;
- Frame made entirely of stainless steel
- Castors, supports, ball bearings, drawer interiors and guides made of stainless steel
- Drawer handles made of aluminium

63 kg



700 kg

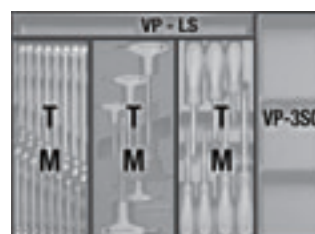

h	max
83 mm	25 kg
170 mm	30 kg

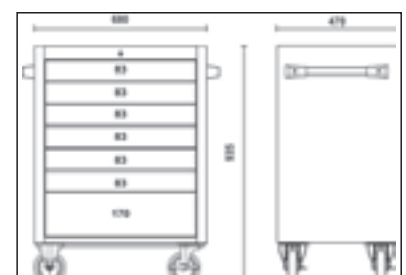
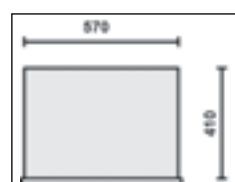

SPARK-PROOF TOOLS

COPPER-BERILLIUM Cu-Be

The **Beta** spark-proof tools are specially designed for safe operations in environments subject to potential risk of explosion, in the presence of flammable liquids or gases, or for any applications that require using perfectly antimagnetic, corrosion-resistant tools.



The Beta sparkproof tools are certified by the Federal Institute for Materials Research and Testing, BAM, under European Directive 99/92/EC.

CLASSIFICATION OF AREAS SUBJECT TO EXPLOSION RISK			
ATEX	HIGH	MEDIUM-LOW	EXTREMELY LOW
GASES	ZONE 0 An area in which an explosive atmosphere consisting of a mixture of air and flammable substances in the form of gas, vapour or mist is continuously present or present for long periods or frequently.	ZONE 1 An area in which an explosive atmosphere consisting of a mixture of air and flammable substances in the form of gas, vapour or mist is likely to occur in normal operation.	ZONE 2 An area in which an explosive atmosphere consisting of a mixture of air and flammable substances in the form of gas, vapour or mist is not likely to occur in normal operation but, if it does occur, will persist for a short period only.
	ZONE 20 An area in which an explosive atmosphere in the form of a cloud of combustible dust in air is continuously present or present for long periods or frequently.	ZONE 21 An area in which an explosive atmosphere in the form of a cloud of combustible dust in air is likely to occur in normal operation occasionally.	ZONE 22 An area in which an explosive atmosphere in the form of a cloud of combustible dust in air is not likely to occur in normal operation but, if it does occur, will persist for a short period only.
DUSTS			



WARNING! Risk of explosion in ACETYLENE environment

The mechanical characteristics of sparkproof tools differ from those of normal steel tools. Sparkproof tools should be used with extreme caution, avoiding overloads.

30BA

sparkproof drift punches



Ø mm	L mm	S mm	1	000300806
5	150	15	1	000300806
8	150	17	1	000300808
10	150	19	1	000300810

31BA

sparkproof pin punches



Ø mm	L mm	1	000310853
3	110	1	000310853
4	110	1	000310854
6	115	1	000310856
8	120	1	000310858

32BA

sparkproof centre punch



Ø mm	1	000320811
10	1	000320811

34BA

sparkproof flat chisels



L mm	A mm	1	000340801
200	22	1	000340801
250	23	1	000340803
300	24	1	000340802

39BA

sparkproof wedges



L mm	A mm	1	000390801
150	40	1	000390801
230	40	1	000390802
250	40	1	000390803

42BA

sparkproof combination wrenches, open bi-hex ring ends



Ø mm	L mm	1	000420806
6x6	105	1	000420806
7x7	105	1	000420807
8x8	120	1	000420808
9x9	120	1	000420809
10x10	135	1	000420810
11x11	135	1	000420811
12x12	150	1	000420812
13x13	150	1	000420813
14x14	175	1	000420814
15x15	175	1	000420815
16x16	195	1	000420816
17x17	200	1	000420817
18x18	215	1	000420818
19x19	220	1	000420819
20x20	230	1	000420820
21x21	240	1	000420821
22x22	250	1	000420822
24x24	268	1	000420824
27x27	290	1	000420827
28x28	290	1	000420828
30x30	313	1	000420830
32x32	333	1	000420832
35x35	360	1	000420835
36x36	355	1	000420836
38x38	430	1	000420838
41x41	430	1	000420841
46x46	480	1	000420846
50x50	520	1	000420850
55x55	560	1	000420855
60x60	580	1	000420860
*65x65	595	1	000420865
*70x70	630	1	000420870

42BA-AS

sparkproof combination wrenches, open bi-hex ring ends



Ø "	L mm	1	000420950
3/8x3/8	128	1	000420950
7/16x7/16	135	1	000420951
1/2x1/2	140	1	000420953
9/16x9/16	163	1	000420954
5/8x5/8	177	1	000420956
11/16x11/16	195	1	000420957
3/4x3/4	215	1	000420959
13/16x13/16	230	1	000420961
7/8x7/8	235	1	000420962
15/16x15/16	256	1	000420964
1x1	266	1	000420965
1.1/16x1.1/16	283	1	000420967
1.1/8x1.1/8	297	1	000420969
1.3/16x1.3/16	308	1	000420970
1.1/4x1.1/4	324	1	000420973

55BA

sparkproof double open end wrenches



Ø mm	L mm	1	000550801
6x7	90	1	000550801
8x9	100	1	000550802
8x10	100	1	000550795
9x11	110	1	000550797
10x11	120	1	000550803
12x13	130	1	000550804
13x14	133	1	000550799
14x15	145	1	000550805
14x17	150	1	000550806
16x17	165	1	000550807
18x19	170	1	000550809
20x22	185	1	000550811
21x23	210	1	000550813
22x24	210	1	000550815
24x26	230	1	000550817
24x27	230	1	000550818
25x28	230	1	000550819
27x29	246	1	000550820
30x32	265	1	000550822
36x38	320	1	000550826
36x41	335	1	000550828
41x46	355	1	000550829
*46x50	370	1	000550830
*50x55	385	1	000550831
*55x60	415	1	000550832

55BA-AS

sparkproof double open end wrenches



Ø "	L mm	1	000550853
3/8x7/16	110	1	000550853
1/2x9/16	130	1	000550854
5/8x11/16	160	1	000550857
3/4x13/16	180	1	000550859
7/8x15/16	210	1	000550865
1x1.1/16	230	1	000550868
1.1/8x1.3/16	245	1	000550870
1.1/4x1.5/16	255	1	000550872

58BA

sparkproof open end slogging wrenches



Ø mm	L mm	1	000580817
17	125	1	000580817
19	125	1	000580819
22	135	1	000580822
24	150	1	000580824
27	165	1	000580827
30	180	1	000580830
32	190	1	000580832
36	210	1	000580836
38	220	1	000580838
41	230	1	000580841
46	240	1	000580846
50	255	1	000580850
*55	305	1	000580855
*60	315	1	000580860
*65	335	1	000580865
*70	370	1	000580870
*75	375	1	000580875
*80	400	1	000580880



78BA

sparkproof bi-hex ring slogging wrenches



mm	L mm		
17	145	1	000780817
19	145	1	000780819
22	165	1	000780822
24	140	1	000780824
27	155	1	000780827
30	165	1	000780830
32	180	1	000780832
34	192	1	000780834
36	208	1	000780836
38	215	1	000780838
41	225	1	000780841
46	245	1	000780846
50	250	1	000780850
55	265	1	000780855
60	275	1	000780860
65	295	1	000780865
70	310	1	000780870
75	325	1	000780875
80	340	1	000780880

78BA-AS

sparkproof bi-hex ring slogging wrenches



"	L mm		
1.1/4	177	1	000780910
1.7/16	208	1	000780912
1.5/8	225	1	000780914
1.13/16	243	1	000780916
2	254	1	000780918
2.3/16	264	1	000780920
2.3/8	275	1	000780922
*2.9/16	286	1	000780924
*2.15/16	311	1	000780926
*3.1/8	325	1	000780928
*3.1/2	355	1	000780930

89BA

spark-proof single ring wrenches



mm	L mm		
10	200	1	000890810
11	210	1	000890811
12	220	1	000890812
13	230	1	000890813
14	240	1	000890814
16	260	1	000890816
17	270	1	000890817
18	280	1	000890818
19	300	1	000890819
20	310	1	000890820
22	330	1	000890822
24	350	1	000890824
27	370	1	000890827
30	400	1	000890830
32	420	1	000890832

90BA

sparkproof double ended offset ring wrenches



mm	L mm		
6x7	122	1	000900801
8x9	128	1	000900802
10x11	155	1	000900803
12x13	175	1	000900806
14x15	200	1	000900808
14x17	220	1	000900809
16x17	230	1	000900811
16x18	235	1	000900812
18x19	265	1	000900815
20x22	295	1	000900818
21x23	298	1	000900820
22x24	315	1	000900821
24x26	333	1	000900822
24x27	340	1	000900823
30x32	395	1	000900824
34x36	410	1	000900826
*36x41	450	1	000900828
*41x46	470	1	000900829
*46x50	490	1	000900830

91BA

sparkproof heavy duty offset ring wrenches



mm	∅ mm		
24	38	1	000910824
27	42	1	000910827
30	48	1	000910830
32	49	1	000910832
36	54	1	000910836
41	62	1	000910841
*46	69	1	000910846
*50	75	1	000910850
*55	82	1	000910855

92BA

sparkproof tubes for item 91BA



	L mm	91BA mm	∅ mm		
92BA/1	460	24÷30	25	1	000920810
92BA/2	610	32÷41	28	1	000920820
*92BA/3	760	46÷55	32	1	000920830

93BA

ratcheting double-ended offset ring wrench for scaffolding bolts, sparkproof



mm	L mm		
21x22	345	1	000930821

95BA

double ended flat ring wrenches, sparkproof



mm	L mm		
7x9	115	1	000950801
8x10	115	1	000950802
10x11	140	1	000950804
10x12	140	1	000950805
12x14	145	1	000950806
14x17	165	1	000950807
*16x18	170	1	000950809
*17x19	185	1	000950808
*18x19	185	1	000950810
*19x22	200	1	000950812
*21x23	230	1	000950815
*24x27	255	1	000950817
*30x32	295	1	000950820

96BA

sparkproof offset hexagon key wrenches

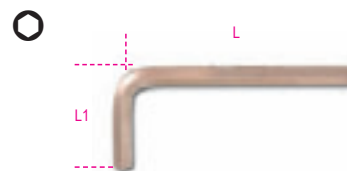

mm	L mm	L1 mm		
1,5	50	17	1	000960760
2	50	16	1	000960762
2,5	56	20	1	000960761
3	63	21	1	000960763
4	69	25	1	000960764
5	78	29	1	000960765
6	88	33	1	000960766
7	93	34	1	000960767
8	97	36	1	000960768
9	104	37	1	000960769
10	110	39	1	000960770
12	122	44	1	000960772

96BA/BP

ball head offset hexagon key wrenches, sparkproof

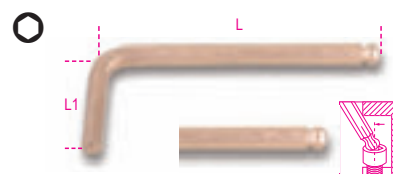

mm	L mm	L1 mm		
1,5	50	16	1	000961800
2	50	16	1	000961801
2,5	63	20	1	000961802
3	60	20	1	000961803
3,5	70	25	1	000961799
4	66	25	1	000961804
5	75	28	1	000961805
6	84	32	1	000961806
8	92	36	1	000961808
10	102	40	1	000961810
12	113	45	1	000961812

99BA

sparkproof hook wrenches with square noses, for ring nuts UNI/ISO 2982, 2983



mm	A mm		
32-75	4,0	1	000990803
50-120	4,5	1	000990805
115-170	4,5	1	000990811

110BA

sparkproof adjustable wrenches



L mm	A max mm		
100	13	1	001100810
150	18	1	001100815
200	24	1	001100820
250	30	1	001100825
300	36	1	001100830
375	46	1	001100837
*450	55	1	001100845
*600	65	1	001100860

330BA

sparkproof pipe cutters for gas pipes



330BA/2	Ø max mm	L mm		
	50	375	1	003300802

330BA/2R

spare pin and knife for gas pipe cutter 330BA, sparkproof



330BA/2-R	1	003300822
-----------	---	-----------

363BA

sparkproof heavy duty pipe wrenches



L mm	Ø max mm	Ø max mm		
150	1 1/2" gas	20	1	003630815
200	1" gas	30	1	003630820
250	1 1/2" gas	49	1	003630825
300	2" gas	60	1	003630830
350	2" gas	60	1	003630835
450	2 1/2" gas	76	1	003630845
600	3" gas	90	1	003630860

378BA

sparkproof pipe wrench, Swedish pattern, made from copper/beryllium alloy



L mm	Ø max "		
430	1" 1/2 gas	1	003780800
530	2" gas	1	003780801

386BA

sparkproof heavy duty reversible chain pipe wrenches

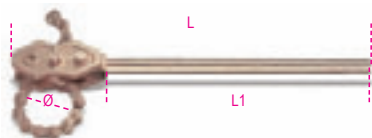

L mm	Ø max mm	L1 mm		
600	100	470	1	003860806
900	200	750	1	003860809



921BA

sparkproof bi-hex sockets

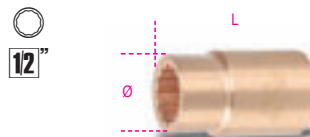

mm	Ø mm	L mm		
8	24,0	40	1	009210808
9	24,0	40	1	009210809
10	16,5	40	1	009210810
11	17,5	40	1	009210811
12	18,5	40	1	009210812
13	19,5	40	1	009210813
14	20,0	40	1	009210814
15	21,5	40	1	009210815
16	24,0	40	1	009210816
17	25,0	40	1	009210817
18	25,0	40	1	009210818
19	28,0	42	1	009210819
20	29,0	42	1	009210820
21	30,0	43	1	009210821
22	30,5	43	1	009210822
24	34,0	43	1	009210824
25	36,0	43	1	009210825
26	37,5	43	1	009210826
27	37,5	45	1	009210827
28	38,9	46	1	009210828
30	41,5	46	1	009210830
32	43,5	46	1	009210832

921BA/21 - 921BA/22

sparkproof 1/2" wobble extension bars



921BA/21	L mm	Ø mm		
	125	30	1	009210842
921BA/22	250	31	1	009210844

921BA/25

sparkproof 1/2" drive universal joint



L mm	Ø mm	1/2"	1/2"		
80	25	1/2	1/2	1	009210845

921BA/42

sparkproof 1/2" drive sliding T handle



L mm		
250	1	009210846

921BA/50

sparkproof 1/2" drive
push-through square ratchet

1 1/2"



L	D	A		
mm	mm	mm		
250	45	16,5	1	009210850

921BA/R50

sparkproof
spare set

1 1/2"



1/2"		
1	009210851	

926BA

sparkproof bi-hex hand sockets

3/4"

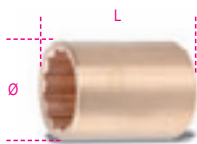

mm	Ø	L		
mm	mm	mm		
24	40	55	1	009260824
26	40	55	1	009260826
27	40	55	1	009260827
28	41	55	1	009260828
30	43	60	1	009260830
32	45	60	1	009260832
34	48	60	1	009260834
36	50	60	1	009260836
38	53	60	1	009260838
41	57	65	1	009260841
46	63	65	1	009260846
50	68	70	1	009260850

926BA/22

sparkproof 3/4" drive extension bars

3/4"



926BA/22	L	Ø		
	mm	mm		
	200	38	1	009260872

926BA/42

sparkproof 3/4" drive slide T-handle

3/4"



L		
mm		
400	1	009260876

926BA/50

sparkproof 3/4" push-through drive ratchet

3/4"



L	D	A		
mm	mm	mm		
300	61	22	1	009260880

926BA/R50

sparkproof
spare set

3/4"



3/4"		
1	009260881	

937BA

hexagon socket wrenches, sparkproof



mm	L	A		
mm	mm	mm		
13	240	45	1	009370813
17	260	51	1	009370817
19	270	55	1	009370819
22	278	59	1	009370822
24	286	63	1	009370824
27	294	69	1	009370827
30	302	75	1	009370830
32	310	81	1	009370832
*36	330	85	1	009370836
*41	350	90	1	009370841

961BA

sparkproof scrapers



L	A		
mm	mm		
250	39	1	009610802
350	55	1	009610806

963BA

sparkproof pry bars with pointed and flat bent ends



L	A		
mm	mm		
500	24	1	009630801
*800	24	1	009630803
*1000	30	1	009630805

964BA

sparkproof wrench bungs



L		
mm		
385	1	009640801

964BA/L

universal shears for barrels,
sparkproof
For opening edged metal barrels

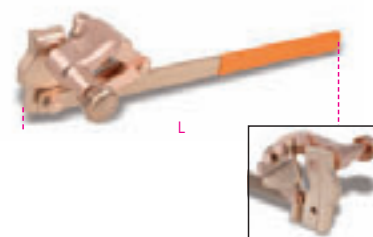

*964BA/L	L		
	mm		
	510	1	009640821

965BA

safety valve wrenches, sparkproof



A	A1	L		
mm	mm	mm		
30	44	200	1	009650830
32	50	300	1	009650832
35	47	250	1	009650835
40	50	300	1	009650840
45	58	350	1	009650845
48	62	375	1	009650848
50	67	400	1	009650850
55	73	450	1	009650855
60	79	500	1	009650860
*65	82	550	1	009650865
*70	85	600	1	009650870

966BA

sparkproof safety valve wrench

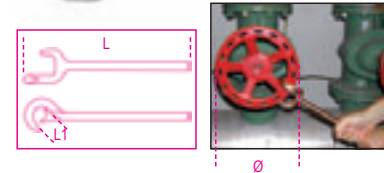

L	L1	Ø		
mm	mm	min+max		
350	40	50÷150	1	009660801

966BA/V

sparkproof safety valve wrenches

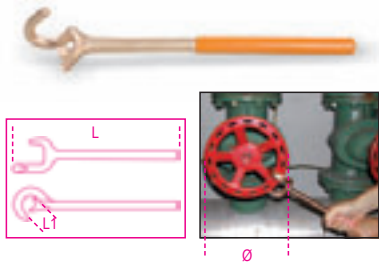

L	L1	Ø min+max	
mm	mm	mm	
370	36	125+250	1 009660812
430	48	250+400	1 009660814

1032BA

sparkproof internal circlip pliers, straight pattern, PVC-coated handles



L	Ø	
mm	mm	
200	40+100	1 010320820

1036BA

sparkproof external circlip pliers, straight pattern, PVC-coated handles



L	Ø	
mm	mm	
200	40+100	1 010360820

1046BA

sparkproof slip joint pliers



L	A max	
mm	mm	
250	32	1 010460801
★300	52	1 010460803

1082BA

sparkproof diagonal cutting nippers

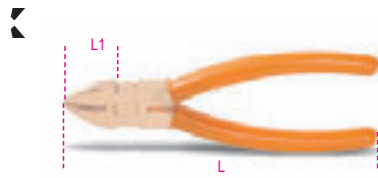

L	L1	
mm	mm	
160	22	1 010820801

1137BA

blasting pliers



L	L1	
mm	mm	
185	30	1 011370801

1137BA/RC

spare blade for item 1137BA



1137BA/RC	1 011370851
-----------	-------------

1150BA

sparkproof combination pliers



L	L1	
mm	mm	
200	40	1 011500820

1162BA

sparkproof extra-long flat knurled nose pliers



L	L1	
mm	mm	
150	54	1 011620815

1166BA

sparkproof extra-long needle knurled nose pliers



L	L1	
mm	mm	
150	54	1 011660815

1270BA

sparkproof screwdrivers for slotted head screws



AxL	L1	
mm	mm	
3x75	178	1 012700803
4x100	209	1 012700804
5x150	250	1 012700805
6x150	270	1 012700806
10x250	382	1 012700810
8x200	312	1 012700808

1272BA

sparkproof screwdrivers for cross head Phillips® screws



PHxDxL	L1	
mm	mm	
1x5x100	209	1 012720801
2x6x150	270	1 012720802
3x8x200	332	1 012720803

1370BA

sparkproof engineer's hammers, wooden shafts



g	A	L	L1	
mm	mm	mm	mm	
500	30	310	108	1 013700805
1000	35	340	137	1 013700810

1370BA/MR

spare shafts for item 1370BA

1370BA/MR 500	1 013700865
1370BA/500	
1370BA/MR 1000	1 013700870
1370BA/1000	

1375BA/PL

sparkproof ball pein and claw hammer, wooden shaft



g	L	L1	Ø		
mm	mm	mm	mm		
680	321	125	30	1	013750800

1377BA

sparkproof ball pein hammer, round head, for coppersmiths and tinsmiths



g	L1	L		
mm	mm	mm		
340	90	280	1	013770834

1377BA/PL

sparkproof ball pein hammer, round head, for coppersmiths and tinsmiths

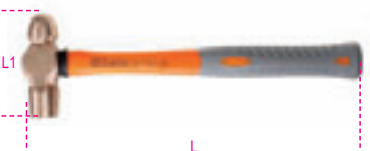

g	L1	L		
mm	mm	mm		
340	90	280	1	013770884

1379BA

sparkproof scraping hammer, wooden shaft



g	L1	L		
mm	mm	mm		
500	142	315	1	013790850

1380BA

sparkproof lump hammers, wooden shafts



g	L1	L		
mm	mm	mm		
1000	100	400	1	013800810
1500	118	400	1	013800815
2000	126	449	1	013800820

1380BA/MR

spare shafts for item 1380BA

1380BA/MR 1000	1380BA/1000	1	013800860
1380BA/MR 1500	1380BA/1500	1	013800865
1380BA/MR 2000	1380BA/2000	1	013800870

1381BA

sparkproof sledge hammers, wooden shafts



g	L1	L		
mm	mm	mm		
5000	179	900	1	013810850
*8000	190	900	1	013810858

1381BA/MR

spare shaft for item 1381BA

1381BA/MR 5000	1381BA/5000	1	013810870
*1381BA/MR 8000	1381BA/8000	1	013810878

1390BA

spark-proof soft face hammer



Ø	L	L1		
mm	mm	mm		
*52	370	130	1	013900805

1390BA/R

spare nylon faces for item 1390BA



D			
mm			
52	4	013900885	

1602BA

sparkproof crimping pliers for insulated terminals, lightweight series



mm²	L		
mm²	mm		
0.75±6	200	1	016020801

1701BA

sparkproof hexagon chisels



L	A	S		
mm	mm	mm		
150	12	10	1	017010810
200	16	14	1	017010814
250	18	14	1	017010815
350	19	17	1	017010817

1703BA/A

sparkproof axe



L	L1	A		
mm	mm	mm		
340	145	82	1	017030082

Beta

Beta

1703BA/P

sparkproof pick



A	L	L1	
mm	mm	mm	
56	1050	410	1 017030150

1703BA/PL

sparkproof shovel



A	L1	L	
mm	mm	mm	
240	420	990	1 017030200

1717BA

sparkproof rigid spatulas



A		
mm		
60		1 017170801
80		1 017170803

1717BA/1

sparkproof wall scraper



A	L	
mm	mm	
100	220	1 017170805

1719BA8

sparkproof files, 8"



	L	
	mm	
1719BA8/P	200	1 017190801
1719BA8/M	200	1 017190805
1719BA8/R	200	1 017190810
1719BA8/T	200	1 017190815
1719BA8/Q	200	1 017190820

1719BA12

sparkproof files, 12"



	L	
	mm	
1719BA12/P	300	1 017190831

1727BA

sparkproof hacksaw and blade

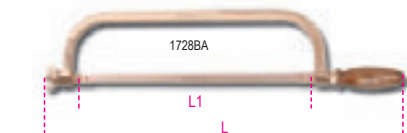

L	L1	
mm	mm	
500	300	1 017270801

1728BA

spark-proof blades for hacksaw frames, made from copper-beryllium alloy



L		
mm		
300		1 017280801

1737BA

brush with sparkproof wires



L	A	
mm	mm	
294	29	1 017370801

1776BA

sparkproof knife



L1	L	
mm	mm	
145	250	1 017760801

1784BA

sparkproof scissors



L		
mm		
225		1 017840822



Beta

PNEUMATIC TOOLS AND ACCESSORIES

For over 15 years Beta Utensili has supplemented its products with a comprehensive range of pneumatic tools and accessories developed for the automotive and industrial maintenance markets: impact wrenches, ratchets, drills, grinders, sanders and many more items.

During this period close co-operation with professional users has been key to ongoing growth. It is on the basis of such growth that Beta's pneumatic tools can boast an excellent reliability/performance ratio. In order to satisfy market requirements in the best possible way, Beta Utensili repairs the pneumatic tools in its Quality Department. This process has allowed the company to improve its know-how to a significant extent and become increasingly responsive to the customer base.



www.beta-tools.com

PDF



1921B1

baby reversible air ratchet

1/4"

CE



Free speed	350 rpm
Max. torque	24 Nm
Bolt capacity	Cl 8.8 M7 ● 11 mm
Bolt capacity	Cl 12.9 M6 ● 10 mm
Air inlet	1/4" GAS
Working pressure	6,2 bar
Internal hose size (Ø)	8 mm
Mean air consumption	68 l/min
Weight	0,4 kg

1/4	kg	1	019210001
-----	----	---	-----------

1921M1

compact reversible air ratchet

1/4"

CE



Free speed	200 rpm
Max. torque	27 Nm
Bolt capacity	Cl 8.8 M7 ● 11 mm
Bolt capacity	Cl 12.9 M6 ● 10 mm
Air inlet	1/4" GAS
Working pressure	6,2 bar
Internal hose size (Ø)	8 mm
Mean air consumption	96 l/min
Weight	0,6 kg

1/4	kg	0,6	1	019210005
-----	----	-----	---	-----------

1921M2

compact reversible air ratchet

3/8"

CE



Free speed	200 rpm
Max. torque	27 Nm
Bolt capacity	Cl 8.8 M7 ● 11 mm
Bolt capacity	Cl 12.9 M6 ● 10 mm
Air inlet	1/4" GAS
Working pressure	6,2 bar
Internal hose size (Ø)	8 mm
Mean air consumption	96 l/min
Weight	0,6 kg

3/8	kg	0,6	1	019210015
-----	----	-----	---	-----------

1921N3

reversible ratchet

1/2"

CE



Free speed	150 rpm
Max. torque	68 Nm
Bolt capacity	Cl 8.8 M10 ● 16 mm
Bolt capacity	Cl 12.9 M8 ● 13 mm
Air inlet	1/4" GAS
Working pressure	6,2 bar
Internal hose size (Ø)	10 mm
Mean air consumption	140 l/min
Weight	1,2 kg

1/2	kg	1,2	1	019210025
-----	----	-----	---	-----------

1921I

impact reversible ratchet

1/2"

CE



Free speed	400 rpm
Max. torque	101 Nm
Bolt capacity	Cl 8.8 M10 ● 16 mm
Bolt capacity	Cl 12.9 M8 ● 13 mm
Air inlet	1/4" GAS
Working pressure	6,2 bar
Internal hose size (Ø)	10 mm
Mean air consumption	235 l/min
Weight	1,3 kg

1/2	kg	1,3	1	019210035
-----	----	-----	---	-----------

Beta

1924B

compact reversible impact wrench

• "Pin Clutch" impulse device

3/8"

CE



Free speed	10,000 rpm
Max. torque	353 Nm
Bolt capacity	Cl 8.8 M16 ● 24 mm
Bolt capacity	Cl 12.9 M14 ● 21 mm
Air inlet	1/4" GAS
Working pressure	6,2 bar
Internal hose size (Ø)	8 mm
Mean air consumption	80 l/min
Weight	1,5 kg

3/8	kg	1,5	1	019240021
-----	----	-----	---	-----------

1924CD

reversible impact wrench, made from composite material

• Double hammer impulse device

3/8"

CE



Free speed	10,000 rpm
Max. torque	410 Nm
Bolt capacity	Cl 8.8 M16 ● 24 mm
Bolt capacity	Cl 12.9 M14 ● 21 mm
Air inlet	1/4" GAS
Working pressure	6,2 bar
Internal hose size (Ø)	8 mm
Mean air consumption	79 l/min
Weight	1,3 kg

3/8	kg	1,3	1	019240007
-----	----	-----	---	-----------

1927CD

reversible impact wrench, made from composite material

- Double hammer impulse device



Free speed	7,000 rpm
Max. torque	1.020 Nm
Bolt capacity	CI 8.8 M22●34 mm
Bolt capacity	CI 12.9 M18●27 mm
Air inlet	1/4" GAS
Working pressure	6,2 bar
Internal hose size (Ø)	10 mm
Mean air consumption	130 l/min
Weight	1,9 kg

■	kg	1	019270007
1/2	1,9		

1927P

reversible impact wrench, made from composite material

- Double hammer impulse device



Free speed	7,500 rpm
Max. torque	1.750 Nm
Bolt capacity	CI 8.8 M24●36 mm
Bolt capacity	CI 12.9 M20●30 mm
Air inlet	1/4" GAS
Operating pressure	6,2 bar
Internal hose size (Ø)	10 mm
Mean air consumption	290 l/min
Weight	2 kg

■	kg	1	019270008
1/2	2,0		

1927XM

compact reversible impact wrench

- Single hammer impulse device



Free speed	10,000 rpm
Max. torque	770 Nm
Bolt capacity	CI 8.8 M22●34 mm
Bolt capacity	CI 12.9 M18●27 mm
Air inlet	1/4" GAS
Operating pressure	6,2 bar
Internal hose size (Ø)	10 mm
Mean air consumption	122 l/min
Weight	1.3 kg

■	kg	1	019270030
1/2	1,3		

1927A

reversible impact wrench

- "Pin Clutch" impulse device



Free speed	7,000 rpm
Max. torque	610 Nm
Bolt capacity	CI 8.8 M22●34 mm
Bolt capacity	CI 12.9 M18●27 mm
Air inlet	1/4" GAS
Operating pressure	6,2 bar
Internal hose size (Ø)	10 mm
Mean air consumption	160 l/min
Weight	2.7 kg

■	kg	1	019270002
1/2	2,7		

1927AN

Angle reversible impact wrench

- Single hammer impulse device



Max. torque	244 Nm
Bolt capacity	244 Nm
Bolt capacity	CI 8.8 M14●21 mm
Air inlet	CI 12.9 M12●19 mm
Operating pressure	1/4" GAS
Internal hose size (Ø)	6,2 bar
Mean air consumption	10 mm
Weight	2.1 kg
Peso	2,1 kg

■	kg	1	019270012
1/2	2,1		

1927SP-AM

magnetic support for pneumatic impact wrench

- Fitted with two high-powered magnets with protective rubber tops
- Can accommodate 1 1/2" impact wrench, 4 sockets and 1 torque wrench
- Capacity: 10 kg



■	kg	1	019270000
400			

Beta

1928CD

reversible impact wrench,
made from composite material
• Double hammer impulse device



Free speed	4,500 rpm
Max. torque	1,800 Nm
Bolt capacity	CI 8.8 M27 ● 41 mm
Bolt capacity	CI 12.9 M24 ● 36 mm
Air inlet	3/8" GAS
Working pressure	6,2 bar
Internal hose size (Ø)	10 mm
Mean air consumption	215 l/min
Weight	3,5 kg

■	kg	🔧	📦
3/4	3,5	1	019280007

1928DAL

reversible impact wrench
• Double hammer impulse device

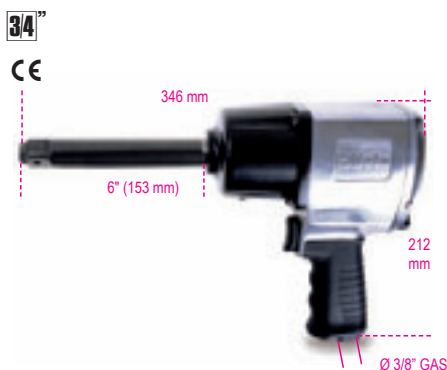

Free speed	5,000 rpm
Max. torque	1,695 Nm
Bolt capacity	CI 8.8 M27 ● 41 mm
Bolt capacity	CI 12.9 M24 ● 36 mm
Air inlet	3/8" GAS
Working pressure	6,2 bar
Internal hose size (Ø)	10 mm
Mean air consumption	240 l/min
Weight	4,8 kg

■	kg	🔧	📦
3/4	4,8	1	019280023

1930CD

reversible impact wrench,
made from composite material
• Double hammer impulse device



Free speed	4,000 rpm
Max. torque	2,445 Nm
Bolt capacity	CI 8.8 M36 ● 55 mm
Bolt capacity	CI 12.9 M30 ● 46 mm
Air inlet	1/2" GAS
Working pressure	6,2 bar
Internal hose size (Ø)	13 mm
Mean air consumption	320 l/min
Weight	7,1 kg

■	kg	🔧	📦
1	7,1	1	019300022

1928DA

reversible impact wrench
• Double hammer impulse device



Free speed	5,000 rpm
Max. torque	1,695 Nm
Bolt capacity	CI 8.8 M27 ● 41 mm
Bolt capacity	CI 12.9 M24 ● 36 mm
Air inlet	3/8" GAS
Working pressure	6,2 bar
Internal hose size (Ø)	10 mm
Mean air consumption	240 l/min
Weight	4,3 kg

■	kg	🔧	📦
3/4	4,3	1	019280022

1928K4

assortment of one reversible impact wrench
and four impact sockets, long series

• "Pin Clutch" impulse device



Free speed	4,000 rpm
Max. torque	1,493 Nm
Bolt capacity	CI 8.8 M27 ● 41 mm
Bolt capacity	CI 12.9 M24 ● 36 mm
Air inlet	3/8" GAS
Working pressure	6,2 bar
Internal hose size (Ø)	10 mm
Mean air consumption	260 l/min
Impact wrench weight	5,2 kg

■	kg	🔧	📦
3/4	9,3	1	019280104
📏 410x330x106 mm			

1930NCD

reversible impact wrench,
made from composite material
• Double hammer impulse device



Free speed	4,000 rpm
Max. torque	2,445 Nm
Bolt capacity	CI 8.8 M36 ● 55 mm
Bolt capacity	CI 12.9 M30 ● 46 mm
Air inlet	1/2" GAS
Working pressure	6,2 bar
Internal hose size (Ø)	13 mm
Mean air consumption	320 l/min
Weight	8,8 kg

■	kg	🔧	📦
1	8,8	1	019300027

1930PA

reversible impact wrench

• Double hammer impulse device



Free speed	3,500 rpm
Max. torque	2.445 Nm
Bolt capacity	CI 8.8 M36 ● 55 mm
Bolt capacity	CI 12.9 M30 ● 46 mm
Air inlet	1/2" GAS
Operating pressure	6,2 bar
Internal hose size (Ø)	13 mm
Mean air consumption	350 l/min
Weight	9.6 kg

1	kg	1	019300032
1	9,6		

1930A

reversible impact wrench

• Double hammer impulse device



Free speed	4,000 rpm
Max. torque	2.445 Nm
Bolt capacity	CI 8.8 M36 ● 55 mm
Bolt capacity	CI 12.9 M30 ● 46 mm
Air inlet	1/2" GAS
Working pressure	6,2 bar
Internal hose size (Ø)	13 mm
Mean air consumption	460 l/min
Weight	9.5 kg

1	kg	1	019300036
1	9,5		

1930ZL

reversible impact wrench

• Double hammer impulse device



Free speed	3,000 rpm
Max. torque	4.068 Nm
Bolt capacity	CI 8.8 M42 ● 65 mm
Bolt capacity	CI 12.9 M36 ● 55 mm
Air inlet	1/2" GAS
Working pressure	6,2 bar
Internal hose size (Ø)	13 mm
Mean air consumption	480 l/min
Weight	15 kg

1 1/2	kg	1	019300070
1 1/2	15		

1930LA

reversible impact wrench

• Double hammer impulse device

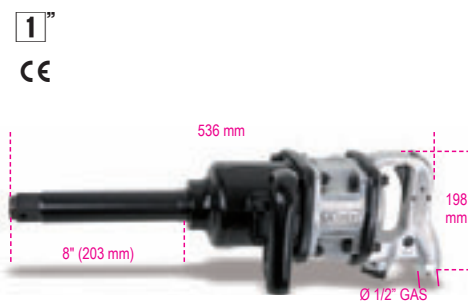

Free speed	4,000 rpm
Max. torque	2.445 Nm
Bolt capacity	CI 8.8 M36 ● 55 mm
Bolt capacity	CI 12.9 M30 ● 46 mm
Air inlet	1/2" GAS
Working pressure	6,2 bar
Internal hose size (Ø)	13 mm
Mean air consumption	460 l/min
Weight	10,6 kg

1	kg	1	019300037
1	10,6		

1930HLA

reversible impact wrench

• Double hammer impulse device



Free speed	3,000 rpm
Max. torque	3.661 Nm
Bolt capacity	CI 8.8 M42 ● 65 mm
Bolt capacity	CI 12.9 M33 ● 50 mm
Air inlet	1/2" GAS
Working pressure	6,2 bar
Internal hose size (Ø)	13 mm
Mean air consumption	460 l/min
Weight	16,4 kg

1	kg	1	019300040
1	16,4		

1931CD6

reversible drill,
made from composite material



Free speed	2,600 rpm
Chuck capacity	1÷6 mm
Power	0,23 kW
Spindle thread	3/8" - 24UNF
Air inlet	1/4" GAS
Working pressure	6,2 bar
Internal hose size (Ø)	8 mm
Mean air consumption	130 l/min
Weight	0,6 kg

0,6	kg	1	019310006
0,6			

1931CD10

reversible drill,
made from composite material



Free speed	1,800 rpm
Chuck capacity	1÷10 mm
Power	0,38 kW
Spindle thread	3/8" - 24UNF
Air inlet	1/4" GAS
Working pressure	6,2 bar
Internal hose size (Ø)	10 mm
Mean air consumption	170 l/min
Weight	1 kg

kg 1,0
1 019310010

1931AN10

reversible angle drill



Free speed	1,400 rpm
Chuck capacity	1÷10 mm
Power	0,38 kW
Spindle thread	3/8" - 24UNF
Air inlet	1/4" GAS
Working pressure	6,2 bar
Internal hose size (Ø)	10 mm
Mean air consumption	150 l/min
Weight	1,1 kg

kg 1,1
1 019310030

1932RS13

reversible drill



Free speed	750 rpm
Chuck capacity	1,5÷13 mm
Power	0,23 kW
Spindle thread	3/8" - 24UNF
Air inlet	1/4" GAS
Working pressure	6,2 bar
Internal hose size (Ø)	10 mm
Mean air consumption	160 l/min
Weight	1,4 kg

kg 1,4
1 019320043

1931CD13

reversible drill,
made from composite material



Free speed	800 rpm
Chuck capacity	1,5÷13 mm
Power	0,38 kW
Spindle thread	1/2" - 20UNC
Air inlet	1/4" GAS
Working pressure	6,2 bar
Internal hose size (Ø)	10 mm
Mean air consumption	170 l/min
Weight	1,3 kg

kg 1,3
1 019310013

1932B10

reversible drill



Free speed	1,800 rpm
Chuck capacity	1÷10 mm
Power	0,23 kW
Spindle thread	3/8" - 24UNF
Air inlet	1/4" GAS
Working pressure	6,2 bar
Internal hose size (Ø)	10 mm
Mean air consumption	160 l/min
Weight	1,2 kg

kg 1,2
1 019320040

1932B13

reversible drill



Free speed	400 rpm
Chuck capacity	1,5÷13 mm
Power	0,34 kW
Spindle thread	1/2" - 20UNC
Air inlet	1/4" GAS
Operating pressure	6,2 bar
Internal hose size (Ø)	10 mm
Mean air consumption	180 l/min
Peso	1,6 kg

kg 1,6
1 019320044

1933

die grinder

- Collect chuck, Ø 3 mm and 6 mm

CE



Free speed	25,000 rpm
Chuck capacity	3 - 6 mm
Power	0,20 kW
Air inlet	1/4" GAS
Working pressure	6,2 bar
Internal hose size (Ø)	10 mm
Mean air consumption	230 l/min
Weight	380 g

g 380 1 019330001

1933I

die grinder

- Collect chuck, Ø 3 mm and 6 mm

CE



Free speed	20,000 rpm
Chuck capacity	3 - 6 mm
Power	0,38 kW
Air inlet	1/4" GAS
Working pressure	6,2 bar
Internal hose size (Ø)	10 mm
Mean air consumption	260 l/min
Weight	670 g

g 670 1 019330005

1933L

long spindle die grinder

- Collect chuck, Ø 3 mm and 6 mm

CE



Free speed	25,000 rpm
Chuck capacity	3 - 6 mm
Power	0,20 kW
Air inlet	1/4" GAS
Working pressure	6,2 bar
Internal hose size (Ø)	10 mm
Mean air consumption	270 l/min
Weight	670 g

g 670 1 019330015

1933IL

long spindle die grinder

- Collect chuck, Ø 3 mm and 6 mm

CE



Free speed	20,000 rpm
Chuck capacity	3 - 6 mm
Power	0,38 kW
Air inlet	1/4" GAS
Working pressure	6,2 bar
Internal hose size (Ø)	10 mm
Mean air consumption	113 l/min
Weight	1,4 kg

kg 1,4 1 019330010

1933AN90

angle grinder

- Collect chuck, Ø 3 mm and 6 mm

CE



Free speed	20,000 rpm
Chuck capacity	3 - 6 mm
Power	0,20 kW
Air inlet	1/4" GAS
Working pressure	6,2 bar
Internal hose size (Ø)	10 mm
Mean air consumption	230 l/min
Weight	510 g

g 510 1 019330020

1934BV

low-speed tyre buffer

- Collect chuck, Ø 3 mm and 6 mm

CE



Free speed	3,700 rpm
Chuck capacity	3 - 6 mm
Power	0,37 kW
Air inlet	1/4" GAS
Operating pressure	6,2 bar
Internal hose size (Ø)	10 mm
Mean air consumption	113 l/min
Weight	0.84 kg

g 840 1 019340000

1934MAV

micro die grinder

CE



Free speed	56,000 rpm
Chuck capacity	3 mm
Power	0,04 kW
Air inlet	1/4" GAS
Operating pressure	6,2 bar
Internal hose size (Ø)	4,5 mm
Mean air consumption	115 l/min
Weight	0.2 kg

g 205 1 019340010

1934MAV70

high-speed micro die grinder

CE



Free speed	70,000 rpm
Chuck capacity	3 mm
Power	0,08 kW
Air inlet	1/4" GAS
Operating pressure	6,2 bar
Internal hose size (Ø)	4,5 mm
Mean air consumption	115 l/min
Weight	0.21 kg

g 210 1 019340030

1935F
reversible air screwdriver



Free speed 800 rpm
Torque range 4-16 Nm
Screw capacity 6-9 M
Bit holder ● 1/4"
Air inlet 1/4" GAS
Working pressure 6,2 bar
Internal hose size (Ø) 10 mm
Mean air consumption 150 l/min
Weight 1,3 kg

kg 1,3
 1 019350045

1936/4A
angle grinder



Free speed 11,000 rpm
Grinding disc size 115 mm
Power 0,66 kW
Spindle thread M14
Air inlet 1/4" GAS
Operating pressure 6,2 bar
Internal hose size (Ø) 10 mm
Mean air consumption 390 l/min
Weight 1,77 kg

kg 1,8
 1 019360024

1936/5A
angle grinder



Free speed 10,000 rpm
Grinding disc size 125 mm
Power 0,66 kW
Spindle thread M14
Air inlet 1/4" GAS
Working pressure 6,2 bar
Ø internal hose size 10 mm
Mean air consumption 390 l/min
Weight 1,9 kg

kg 1,9
 1 019360025

1936/5
angle grinder



Free speed 10,500 rpm
Grinding disc size 125 mm
Power 0,7 kW
Spindle thread M14
Air inlet 1/4" GAS
Working pressure 6,2 bar
Ø internal hose size 10 mm
Mean air consumption 380 l/min
Weight 2 kg

kg 2,0
 1 019360005

1936/7
angle grinder



Free speed 7,000 rpm
Grinding disc size 178 mm
Power 1,4 kW
Spindle thread M14
Air inlet 3/8" GAS
Working pressure 6,2 bar
Ø internal hose size 13 mm
Mean air consumption 500 l/min
Weight 3,6 kg

kg 3,6
 1 019360007

1937
Roto-orbital palm sander, lubrication free,
made from composite material
• Orbit diameter: 5 mm



Free speed 12,000 rpm
Power 0,18 kW
Pad size 150 mm
Orbit diameter 5 mm
Spindle thread 5/16"-24
Air inlet 1/4" GAS
Operating pressure 6,2 bar
Internal hose size (Ø) 10 mm
Mean air consumption 170 l/min
Weight 0,86 kg

kg 0,86
 1 019370001

1937R/P
6-hole pad, Ø 150 mm,
for item 1937



1937R/P
 1 019370002



1937KC

mini roto-orbital sander

- Orbit diameter 4 mm
- 2 sanding pads (Ø 50 mm and Ø 75 mm)
- 10 abrasive paper discs (Ø 50 mm), grain 400, 600, 800
- 10 abrasive paper discs (Ø 75 mm), grain 400, 600, 800

CE



Free speed	15000
Power	0.25
Pad size	50 - 75
Spindle thread	M6 x 1.0
Air inlet	1/4"
Operating pressure	6.2 bar
Internal hose size (Ø)	10
Mean air consumption	79
Polisher weight	0.64
Kit weight	1.4

kg	1,4	1 019370171
----	-----	-------------

1937C...

Abrasive paper discs for item 1937KC



Ø mm	P	
50	400	1 019370175
50	600	1 019370176
50	800	1 019370177
75	400	1 019370178
75	600	1 019370179
75	800	1 019370180

* Prices refer to 10 pieces

Beta

1937KL

mini polisher

- Sanding pad (Ø 75 mm)
- 2 polishing sponges (Ø 90 mm) - 1937/KL-DSB, 1937/KL-DSG
- Lambswool pad (Ø 90 mm) - 1937/KL-DLA

CE



Free speed	3,200 rpm
Power	0.25 kW
Pad size	75 mm
Spindle thread	M6
Air inlet	1/4" GAS
Operating pressure	6.2 bar
Internal hose size (Ø)	10 mm
Mean air consumption	91 l/min
Polisher weight	0.75 kg
Kit weight	1.8 kg

kg	1,8	1 019370161
----	-----	-------------

1937KL-D

accessories for item 1937KL

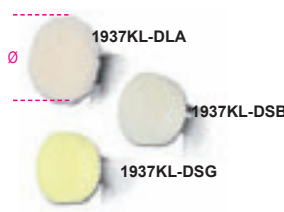

	Ø mm	
1937KL-DLA	90	1 019370164
1937KL-DSB	90	1 019370165
1937KL-DSG	90	1 019370166

1937K...

Pads for items 1937KC and 1937KL



	Ø mm	1937KC	1937KL	
1937KC-RP	50	•		1 019370173
1937KL-RP	75	•	•	1 019370163

1937RT

orbital palm sander, made from composite material, with suction system

- Orbit diameter 5 mm
- Rectangular pad (100x110 mm)
- Delta pad (125x95 mm)

CE



Free speed	10,000 rpm
Orbit diameter	5 mm
Air inlet	1/4" GAS
Operating pressure	6.2 bar
Internal hose size (Ø)	10 mm
Mean air consumption	180 l/min
Weight	0.9 kg
Peso	0,9 kg

kg	0,9	1 019370021
----	-----	-------------

1937RT/R

rectangular pad for item 1937RT



	L mm	L1 mm	
1937RT/R	110	100	1 019370022

1937RT/T

Delta pad for item 1937RT



	L mm	L1 mm	
1937RT/T	125	95	1 019370023

Beta

Beta

1937M

multi-use sander
with 16 accessories

CE



Ø 1/4 GAS



Free speed	3,500 rpm
Power	0,34 kW
Air inlet	1/4" GAS
Working pressure	6,2 bar
Internal hose size (Ø)	10 mm
Mean air consumption	113 l/min
Sander weight	1,5 kg
Kit weight	4,5 kg

kg	4,5	1 019370011
mm	458x495x116	

1937M-01÷11

accessories for item 1937M



L mm	1937M-	
30		1 019370101
30		1 019370102
11		1 019370103
23		1 019370104
11		1 019370105
23		1 019370106
16		1 019370107
13	07	1 019370108
26	07	1 019370109
11	03, 05	1 019370110
23	01, 02, 04, 06	1 019370111

* The prices shown are for 6 pieces

1937N10

pneumatic belt sander

CE



Free speed	20,000 rpm
Power	0,37 kW
Belt size	10x330 mm
Air inlet	1/4" GAS
Working pressure	6,2 bar
Internal hose size (Ø)	10 mm
Mean air consumption	374 l/min
Weight	0,9 kg

kg	0,9	1 019370041
----	-----	-------------

1937N10-GR

sand belts for item 1937N10



	P	
1937N10-GR60	60	1 019370146
1937N10-GR80	80	1 019370148
1937N10-GR100	100	1 019370150
1937N10-GR120	120	1 019370152

The prices shown are for 10 pieces

1937N20

pneumatic belt sander

CE



Free speed	16,000 rpm
Power	0,45 kW
Belt size	20x520 mm
Air inlet	1/4" GAS
Working pressure	6,2 bar
Internal hose size (Ø)	10 mm
Mean air consumption	400 l/min
Weight	1,6 kg

kg	1,6	1 019370051
----	-----	-------------

1937N20-GR

sand belts for item 1937N20



	P	
1937N20-GR60	60	1 019370156
1937N20-GR80	80	1 019370158
1937N20-GR100	100	1 019370160
1937N20-GR120	120	1 019370162

The prices shown are for 10 pieces

1938

Windscreen remover

• Supplied with 1 57 mm straight blade

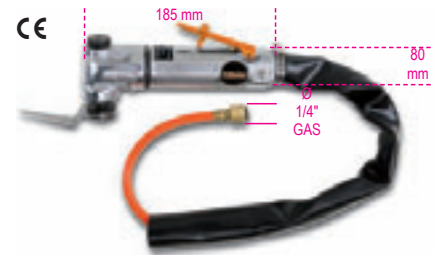

Oscillations/minute	20,000
Air inlet	1/4" GAS
Operating pressure	6,2 bar
Internal hose size (Ø)	6,5 mm
Mean air consumption	200 l/min
Weight	1,0 kg

kg	1,0	1 019380021
----	-----	-------------

1938R/L

blades for windscreen removers

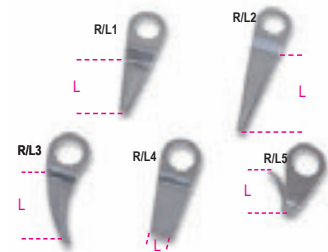

	L mm	
1938R/L1	57	1 019380041
1938R/L2	90	1 019380042
1938R/L3	50	1 019380043
1938R/L4	16	1 019380044
1938R/L5	36	1 019380045

1938R/S5

set of 5 blades for item 1938

1938R/S5	1 019380055
----------	-------------

1940

air hammer



Strokes per minute	3,500
Chisel inlet	○ 11 mm
Piston size	19 mm
Piston stroke	67 mm
Air inlet	1/4" GAS
Working pressure	6,2 bar
Ø internal hose size	8 mm
Mean air consumption	240 l/min
Weight	1,9 kg

kg 1,9 1 019400001

1940MT

spare retainer spring for item 1940



1940MT 5 019400110

1940S...

chisels for air hammers
item 1940



1940SN	5 019400020
1940ST	5 019400021
1940SD	5 019400022
1940SPS	5 019400023
1940SDT	5 019400024

1940/S5

set of 5 chisels for air hammers
item 1940



1940/S5 1 019400030

1940E10

air hammer



• Compatible with chisels with 10-mm hexagon drive



Strokes per minute	2,900
Chisel inlet	○ 10 mm
Piston size	19 mm
Piston stroke	67 mm
Air inlet	1/4" GAS
Operating pressure	6,2 bar
Internal hose size (Ø)	10 mm
Mean air consumption	76 l/min
Weight	1,7 kg

kg 1,7 1 019400010

1940E10/MT

spare retainer spring for item 1940E10



1940E10/MT 5 019400112

1940E10/S...

chisels for air hammers 1940E10

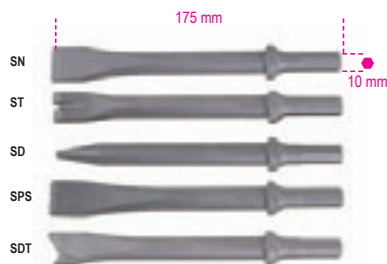

1940E10/SN	5 019400040
1940E10/ST	5 019400041
1940E10/SD	5 019400042
1940E10/SPS	5 019400043
1940E10/SDT	5 019400044

1940E10/S5

set of 5 chisels
for air hammers 1940E10



1940E10/S5 1 019400050

1942A

air saw



Strokes per minute	10,000
Stroke length	10 mm
Air inlet	1/4" GAS
Operating pressure	6,2 bar
Internal hose size (Ø)	8 mm
Mean air consumption	75 l/min
Weight	550 g

g 550 1 019420000

1942LR

Bimetal blades
for air saw 1942A



1942LR 5 019420032

1944

needle scaler



Strokes per minute	3,000
Stroke length	33 mm
N°. of needles	19
Needle size (Ø)	3 mm
Air inlet	1/4" GAS
Working pressure	6,2 bar
Internal hose size (Ø)	8 mm
Mean air consumption	140 l/min
Weight	2,6 kg

kg 2,6 1 019440001

1944AR

set of 19 needles for needle scaler
item 1944



1944AR 1 019440005

1946

air riveter

• Supplied with interchangeable nozzles,
2.4-3.2-4.0-4.8 mm long

CE



Traction power	8000 N
Stroke length	14 mm
Maximum rivet capacity	Ø aluminium 4,8 mm
Working pressure	6,2 bars
Air inlet	6,2 bar
Internal hose size (Ø)	6 mm
Mean air consumption	1,2 l/cycles
Weight	1,5 kg

kg 1,5 1 019460001

1946C4,8

riveter

• Automatic suction
• Supplied assembled for use with 2.4 - 3.2 - 4.0 - 4.8 mm long
steel, stainless steel, aluminium and copper rivets

CE



Traction power	8,900 N
Stroke length	15 mm
Maximum rivet capacity	Stainless steel Ø 4.8 mm
Air inlet	1/4" GAS
Operating pressure	6,2 bar
Internal hose size (Ø)	10 mm
Air consumption	2.6 l/cycle
Weight	1.5 kg

kg 1,5 1 019460006

1946C7,8

riveter

• Automatic suction
• Supplied assembled for use with 4.8 - 5.6 - 6.4 - 7.8 mm long
steel, stainless steel, aluminium and copper rivets

CE



Traction power	16,900 N
Stroke length	22.5 mm
Maximum rivet capacity	Stainless steel Ø 7.8 mm
Air inlet	1/4" GAS
Operating pressure	6,2 bar
Internal hose size (Ø)	10 mm
Air consumption	4.9 l/cycle
Weight	1.8 kg

kg 1,8 1 019460008

1946KF

air riveter for threaded inserts

• Supplied assembled for threaded rivets made of steel,
stainless steel, aluminium and copper, M4, M5, M6, M8

CE



Traction power	14,235 N
Stroke length	7 mm
Maximum rivet capacity	Stainless steel Ø, M8
Air inlet	1/4" GAS
Operating pressure	6,2 bar
Internal hose size (Ø)	10 mm
Air consumption	2.1 l/cycle
Air riveter weight	2.1 kg
Kit weight	3.4 kg

kg 3,4 1 019460012

1946KF/M...

spare pins for item 1946KF



1946KF/M4	1 019460124
1946KF/M5	1 019460125
1946KF/M6	1 019460126
1946KF/M8	1 019460128

1947

bonding gun

CE



Tube size	50x210 mm
Cartridge capacity	350 ml
Air inlet	1/4" GAS
Working pressure	4,8 bar
Internal hose size (Ø)	10 mm
Mean air consumption	120 l/min
Weight	1,1 kg

kg 1,1 1 019470001

1947H

bonding gun

CE



Tube size	210x50 mm
Cartridge capacity	300/310 ml
Air inlet	1/4" GAS
Operating pressure	4 ÷ 8 bar
Internal hose size (Ø)	2,5 mm
Mean air consumption	120 l/min
Weight	750 g

g 750 1 019470011

1947G

grease gun

Die-cast aluminium head
Ergonomic grip for ease of access to tough greasing points
Corrosion-resistant brass valve
Takes 400 g cartridges or bulk grease up to 500 cc
Tube size: 54 (interior) x 260 mm
Air inlet: 1/4" GAS
Operating pressure: 4÷10 bar
Weight: 1.9 kg

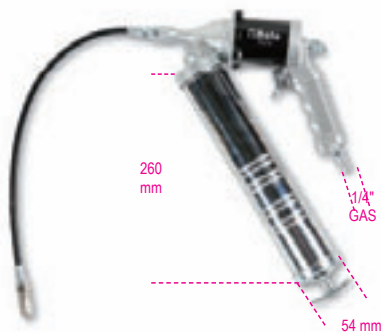

1949BC

progressive blow gun with rubber nozzle

- Hard-wearing, shockproof composite material body
- Replaceable scratchproof rubber nozzle



Aluminium threaded insert	1/4" GAS
Operating pressure	6-8 bar
Maximum operating pressure	15 bar
Mean air consumption	87 l/min
Operating temperature	-20°C ÷ 70°C
Weight	120 g

120 g 1 019490022

1949BC/RU

5 rubber nozzles for item 1949BC



1949BC/RU 1 019490122

1949T

telescopic progressive blow gun

- Hard-wearing, shockproof composite material body
- Telescopic steel swivel tube: 165 mm ÷ 300 mm



Aluminium threaded insert	1/4" GAS
Operating pressure	6-8 bar
Maximum operating pressure	15 bar
Mean air consumption	144 l/min
Operating temperature	-20°C ÷ 70°C
Weight	190 g

190 g 1 019490040

1949F

progressive blow gun

- Made from hard-wearing, shockproof, scratchproof, thermally insulated composite plastic material
- The special valve and the lever allow the circuit to be progressively opened, thus optimizing air flow



Brass threaded insert	1/4" GAS
Operating pressure	6-8 bar
Maximum operating pressure	10 bar
Operating temperature	-15°C ÷ 70°C
Weight	130 g

130 g 5 019490027

1949G

progressive blow gun with air regulator

- Made from hard-wearing, shockproof, scratchproof, thermally insulated composite plastic material
- The special valve and the lever allow the circuit to be progressively opened, thus optimizing air flow



Brass threaded insert	1/4" GAS
Operating pressure	6-8 bar
Maximum operating pressure	10 bar
Operating temperature	-15°C ÷ 70°C
Weight	140 g

140 g 5 019490035

1947G

1 019470051

1948

engraving pen

CE



Maximum hardness	60 HRC
Air inlet	60 HRC
Operating pressure	1/4" GAS
Mean air consumption	6,2 bar
Weight	50 l/min
Peso	150 g

150 g 1 019480001

1948PR

spare tungsten carbide bit for item 1948

- Maximum hardness: 60 HRC



1948PR 1 019480005

Beta

1949DGT

digital tyre inflator

- Operating pressure: 0÷11 bar (2.0÷160 psi)
- 4 units of measurement: psi/bar/kgcm2/kpa
- Backlit LCD display
- Reset feature
- Self-power off after 3 min.
- Pressure release button
- Resolution: 0.05 bar
- ABS housing, protective rubber shell on gauge, shockproof, nonslip handle grip
- Power supply: 2 AAA size 1.5V batteries
- Compatible with coupling 1916G 1/4"



1949DGT	bar	psi	g		
	0÷11	5÷60	280	1	019490020

1949GPE

tyre inflator

- Operating pressure: 0÷11 bars (10÷160 psi)
- Pressure release feature
- Pressure measurement feature
- Gauge coated with shockproof rubber
- 360 degree hose rotation



1949GPE	bar	psi	g		
	0÷11	5÷60	280	1	019490008

1949GPN

tyre inflator,
ABS housing

- CE certified pressure gauge with scale 0.7÷12 bars (graduation: 1/10 bars)
- Two servo-controlled buttons allow accurate, quick tyre inflating (+) and deflating (-)
- Supplied with a calibration certificate
- Fitted with a shockproof, protective shell and an eyelet
- Fitted with a 1/4" GAS threaded coupler
- Swivel air inlet for rubber hose, Ø 7 mm



1949GPN	bar	psi	g		
	0,7÷12	10÷160	810	1	019490011

1949M

tyre pressure tester



1949M	bar	psi	g		
	0÷4	5÷60	280	1	019490400

1951

cleaning gun

- For cleaning car upholstery, carpeting, seats and boots



Free speed	3,600 rpm
Tank capacity	1 L
Air inlet	1/4" GAS
Working pressure	6,2 bar
Internal hose size (Ø)	8 mm
Mean air consumption	110 l/min
Weight	650 g

650	1	019510051
-----	---	-----------

1901BM/8

automatic hose reel
shock-proof plastic body
for compressed air or cold water

- Max. operating pressure: 12 bar

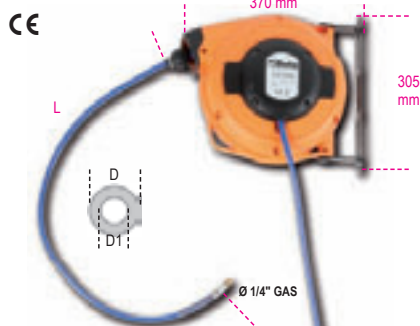

D1xD	L	Ø GAS		
8x12	9+1	1/4"	1	019010111

1901T/10

automatic hose reel,
shock-proof plastic body,
for compressed air or cold water

- Max. operating pressure: 15 bar

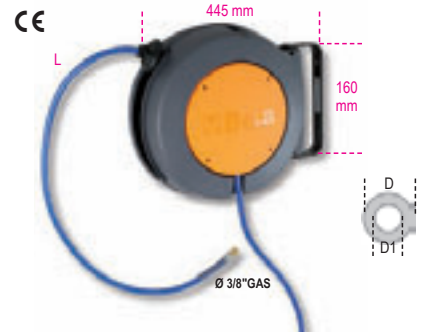

D1xD	L	Ø GAS		
10x14	15+1	3/8"	1	019010210

1910/8 - 1910/10

automatic hose reel,
aluminium body,
for compressed air or cold water

- Max. operating pressure: 15 bar



D1xD	L	A	B	Ø GAS
8x12	9+1	375	130	1/4"

1910/8	1	019100008
--------	---	-----------

D1xD	L	A	B	Ø GAS
10x14	15+1	490	160	3/8"

1910/10	1	019100010
---------	---	-----------

1914

polyurethane recoil hoses, 98 Shore,
extendable

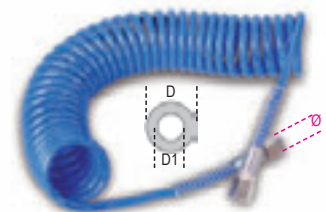

L	D1xD	Ø GAS		
m	mm	BSP		
4	5x8	1/4"	1	019140054
6	5x8	1/4"	1	019140056
10	5x8	1/4"	1	019140060

Beta

1915B

polyurethane recoil hoses, 95 Shore, extendable up to 9 m

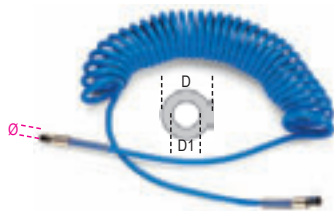

D1xD mm	Ø GAS BSP		
6,5x10	1/4"	1	019150011
8x12	1/4"	1	019150012
11x16	3/8"	1	019150013

1915C

polyurethane recoil hoses, 95 Shore, extendable up to 12 m

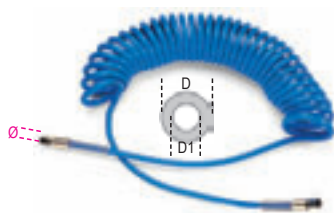

D1xD mm	Ø GAS BSP		
6,5x10	1/4"	1	019150014
8x12	1/4"	1	019150015
11x16	3/8"	1	019150016

1915C/L

polyurethane recoil hoses, 95 Shore, extendable up to 15 m

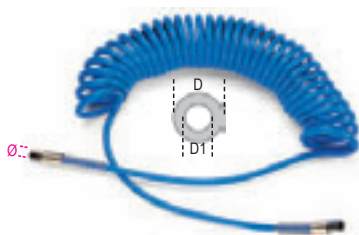

D1xD mm	Ø GAS BSP		
8x12	1/4"	1	019150115
11x16	3/8"	1	019150116

1915D

braided polyurethane hose, 95 Shore, 9 metres long



D1xD mm	Ø GAS BSP		
8x12	1/4"	1	019150017
11x16	3/8"	1	019150018

1915E

braided polyurethane hose, 95 Shore, 12 metres long

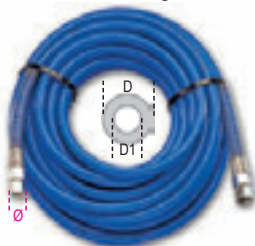

D1xD mm	Ø GAS BSP		
8x12	1/4"	1	019150019
11x16	3/8"	1	019150020

1915E/XL

braided polyurethane coils, 95 Shore, 50 m long



D1xD mm	Ø GAS BSP		
8x12	1/4"	1	019150519
11x16	3/8"	1	019150520

1916I

quick couplings Italian profile male threaded, cylindrical (BSP)



Ø GAS BSP			
1/4"	5	019160001	
3/8"	5	019160002	

1916G

quick couplings European profile male threaded, tapered (BSPT)



Ø GAS BSPT			
1/4"	5	019160005	
3/8"	5	019160010	
1/2"	5	019160012	

1917M

universal ball quick couplers, shockproof rubber, male threaded, cylindrical (BSP)

• Designed for couplings 1916I and 1916G



Ø GAS BSP			
1/4"	5	019170001	
3/8"	5	019170003	
1/2"	5	019170004	

1917F

universal ball quick couplers, shockproof rubber, female threaded, cylindrical (BSP)

• Designed for couplings 1916I and 1916G



Ø GAS BSP			
1/4"	5	019170005	
3/8"	5	019170010	

1917RS

rotary universal coupler

• Made of orange anodized aluminium
female threaded, GAS cylindrical (BSP)
male threaded, GAS conical (BSPT)
• Matches all joints with Italian and European profiles



Ø GAS BSP	Ø GAS BSPT	g		
1/4"	1/4"	57	1	019170250

1919FE1/4

filter-regulator-lubricator



Air in/outlet	1/4" GAS BSPT
Pressure gauge inlet	1/8" GAS BSPT
Maximum air capacity	750 l/min
Maximum pressure	9,5 bar
Operating pressure	0,5 - 8,5 bar
Operating temperature	5 - 60 °C
Filter capacity	5 micron
Cup capacity	15 cc air / 25 cc oil
Weight	700 g

g			
700	1	019190200	

Beta

1919RB-FE1/4

set of spare cups for item 1919FE1/4



1919RB-FE1/4

1 019190210

1919RF-FE1/4

spare filter for item 1919FE1/4



1919RF-FE1/4

1 019190230

1919RM-FE1/4

spare pressure gauge for item 1919FE1/4



1919RM-FE

1 019190220

1919F1/4

filter-regulator-lubricator

1/4"



Air in/outlet 1/4" GAS BSPT
Maximum air capacity 1000 l/min
Maximum pressure 9,5 bar
Operating pressure 0,5 - 8,5 bar
Operating temperature 5 - 60 °C
Filter capacity 5 microns
Cup capacity 60 cc air / 90 cc oil
Weight 1.3 kg

kg
1,3

1 019190250

1919F3/8

filter-regulator-lubricator

3/8"



Air in/outlet 3/8" GAS BSPT
Maximum air capacity 1350 l/min
Maximum pressure 9,5 bar
Operating pressure 0,5 - 8,5 bar
Operating temperature 5 - 60 °C
Filter capacity 5 microns
Cup capacity 60 cc air / 90 cc oil
Weight 1.3 kg

kg
1,3

1 019190350

1919F1/2

filter-regulator-lubricator

1/2"



Air in/outlet 1/2" GAS BSPT
Maximum air capacity 2500 l/min
Maximum pressure 9,5 bar
Operating pressure 0,5 - 8,5 bar
Operating temperature 5 - 60 °C
Filter capacity 5 microns
Cup capacity 60 cc air / 90 cc oil
Weight 1.3 kg

kg
1,3

1 019190450

1919RB-F

set of spare cups for filters
item 1919F - 1/4", 3/8" and 1/2"



1919RB-F

1 019190510

1919RF-F

spare filter for filters
item 1919F - 1/4", 3/8" and 1/2"



1919RF-F

1 019190530

1919RM-F

spare pressure gauge for filters
item 1919F - 1/4", 3/8" and 1/2"



1919RM-F

1 019190520

1919ML

mini lubricators



Ø	L	Ø	
	mm	mm	
1/4"	63	36	1 019190030
3/8"	63	36	1 019190032

1919SC

mini water separator

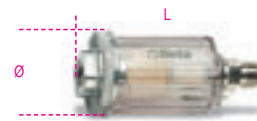

Ø	L	Ø	
	mm	mm	
1/4"	80	40	1 019190035

1919L

ISO 32 lubricating oil

Density 20°C 875 Kg/m³
Viscosity 40°C 32 cSt
Flammability COC 210°C



cc
500

5 019190050

CONTAINERS AND ASSORTMENTS



2001/B26

fabric wallet with assortment of 26 tools



2001/B26 1 020010050

- 55 6x7 - 8x9 - 10x11 - 12x13 - 14x15 - 16x17 mm
- 96N/SC9 1,5 - 2 - 2,5 - 3 - 4 - 5 - 6 - 8 - 10 mm
- 1044F 250 mm
- 1128BMX 145 mm
- 1150 180 mm
- 1201 3x75 - 4x100 - 5,5x150 mm
- 1202 PH1x80 - PH2x100 mm
- 1370 300 g
- 1692 2 m
- 1770A 9 mm

2001/BV 1 020010051

2005PA/D

tool pouch, empty, made from nylon, with belt



2005PA/D 1 020050000

2005PA/S

tool pouch, empty, made from nylon, with belt



2005PA/S 1 020050020

2009N/BV

leather bag for maintenance



mm
530x190x210 1 020090200

2009ID

bag with assortment of tools for plumbing maintenance



2009ID 1 020090012
(2009N/BV+5980ID)

2029/VV

tool case, made of thick polypropylene, aluminium edged

2 interior tool panels



mm
490x380x230 1 020290000

2029E

tool cases with assortments of tools for electronic and electrotechnical maintenance



2029BG-MQ 1 020290257
(2029/VV+5980MQ)
2029 ET/B 1 020290221
(2029/VV+5980ET/B)
2029 EL/B 1 020290217
(2029/VV+5980EL/B)

2029/RT

universal shoulder strap for bags and cases



2029/RT 1 020290900

2032/VV

wall tool case, made from plastic



mm
450x390x170 1 020320010

2032E

tool cases with assortments of tools for electronic and electrotechnical maintenance



2032ET/A 1 020320118
(2032/VV+5980ET/A)
2032 EL/A 1 020320114
(2032/VV+5980EL/A)

2032/TV

tool trolley, made from plastic

2 tool panels
Tool pocket
Interior bottom with removable partitions



mm
430x370x200 1 020320110



2032/TE

tool trolley with assortments of tools for electronic and electrotechnical maintenance



2032TET/A (2032/TV+5980ET/A)	1	020320228
2032T EL/A (2032/TV+5980EL/A)	1	020320214

2033 P/VV

wall tool case, made from aluminium, with ABS sides

2 tool panels
Interior bottom with removable partitions



500x380x200	1	020330300
-------------	---	-----------

2033P

tool cases with assortments of tools for electronic and electrotechnical maintenance



2033PET/B (2033P/VV+5980ET/B)	1	020330127
2033PEL/A (2033P/VV+5980EL/A)	1	020330114
2033PEL/B (2033P/VV+5980EL/B)	1	020330115

2036/TV

tool trolley, made of thick polypropylene, aluminium edged

2 tool panels
Telescopic handle
Ball bearing castors



490x380x260	1	020360000
-------------	---	-----------

2036E

trolley with assortments of tools for electronic and electrotechnical maintenance



2036TET/B (2036/TV+5980ET/B)	1	020360123
2036EL/B (2036/TV+5980EL/B)	1	020360118



2037/TV

tool trolley, made of thick polypropylene, with 4 pivoting castors

Highly shock resistant. Suitable for tool transportation in aircraft.

2 removable tool panels.
Built-in document pocket.
4 removable pivoting castors for horizontal trolley handling.
2 tote-trays included
2 TSA approved locks with keys
Rubber-coated handle



420x325x275 mm	1	020370000
----------------	---	-----------

2041UC

Utility Case with assortment of 33 tools



2041UC	1	020410200
--------	---	-----------

- 55 6x7 - 8x9 - 10x11 - 12x13 - 14x15 - 16x17 mm
- 96/SC9 1,5 - 2 - 2,5 - 3 - 4 - 5 - 6 - 8 - 10 mm
- 111 200 mm
- 1048V 250 mm
- 1128BMX 145 mm
- 1150 180 mm
- 1201 2,5x50 - 3x75 - 4x100 - 5,5x100 - 6,5x150 mm
- 1202 PH0x60 - PH1x80 - PH2x100 mm
- 1370 300 g
- 1692 3m
- 1771 170 mm
- 1834/70 70 Lumen / 140 mm
- 1639NS-N 25m
- 1696 200 mm

535x282x87 mm - 4,5 Kg



2051N

assortment of 55 tools
for nautical maintenance
with shockproof polypropylene case



2051N 1 020510200

- 42 7 - 8 - 10 - 12 - 13 - 14 - 17 - 19 mm
 - 55AS 3/8x7/16 - 1/2x9/16 - 5/8x11/16"
 - 96/SC9 \varnothing 1,5÷10 mm
 - 111 200 mm
 - 920A \varnothing 10 - 12 - 13 - 14 - 17 - 19 mm
 - 920AS \varnothing 7/16 - 1/2 - 9/16 - 11/16 - 7/8"
 - 920/22 255 mm - \square 1/2 - \blacksquare 1/2
 - 920/25 \square 1/2 - \blacksquare 1/2
 - 920/42 \blacksquare 1/2
 - 920/55 \blacksquare 1/2
 - 956C \square 1/2 - 16 - 20,8 mm
 - 1048 250 mm
 - 1084BM 160 mm
 - 1128BMX 145 mm
 - 1150BM 180 mm
 - 1166BM 160 mm
 - 1201 \varnothing 3x75 - 4x100 - 5,5x150 - 6,5x150 mm
 - 1202 \varnothing PH1x80 - PH2x100 mm
 - 1390 \varnothing 35 mm
 - 1490/2 \varnothing max 240 mm
 - 1737 145 mm
 - 1778X
 - 1995 WD40 400 ml
 - 1639NS-N 25m
- \approx 585x393x92 mm - \blacksquare 9 kg

2055HB

"Home Bag" case with assortment of 24 tools



2055HB 1 020550210

- 55 6x7 - 8x9 - 10x11 - 12x13 mm
 - 96N/SC9 1,5 - 2 - 2,5 - 3 - 4 - 5 - 6 - 8 - 10 mm
 - 1128BMX 145 mm
 - 1150 180 mm
 - 1048V 250 mm
 - 1201 3x75 - 4x100 - 5,5x100 mm
 - 1202 PH0x60 - PH1x80 - PH2x100 mm
 - 1370 300 g
 - 1692 3m
- \approx 373x275x70 mm - \blacksquare 3 Kg

2060/VV

hard cavity wall tool case

Floating, waterproof/watertight
Made from thick resin
With manual pressure release valve



IP67

490x410x210 mm 1 020600101



2080/V6

organizer tool case with 6 removable tote-trays and adjustable partitions



2080/V6 385x320x60 mm 1 020800060

2080/V6-U

removable tote-tray for organizer tool case 2080/V6



2080/V6-U 90x60x50 mm 1 020800066

2080/V12

organizer tool case with 12 removable tote-trays



2080/V12 300x145x330 mm 1 020800000

2080/V12-...

removable tote-tray for organizer tool case 2080/V12



2080/V12-S 95x75x65 mm 3 020800013
 2080/V12-M 145x75x65 mm 2 020800015
 2080/V12-L 295x75x65 mm 1 020800020

C4 - 2104

tool basket made of technical fabric

Removable internal tool panel
Internal and external pockets and elastic tool holder
Sturdy waterproof base with rubber feet
Supplied with shoulder strap



C4 2104VU/0 (C4+5915VU/0) 360x330x260x mm - \blacksquare 2,5 kg 1 021040000 1 021040121



C5 - 2105

tool rucksack, made of technical fabric



C5	1	021050000
2105VU0 (C5+5915VU/0)	1	021050121

500x400x180 mm - 2,5 Kg

C6T - 2106

tool rucksack, made of technical fabric, with castors



C6T	1	021060010
2106T/VU0 (C6T+5915VU/0)	1	021060121

480x370x220 mm - 4,5 kg

C7 - 2107

technical fabric tool bag

- 2 removable interior tool panels
- Interior PC pocket
- 2 exterior front pockets
- Interior bottom made of plastic, with removable partitions



C7	1	021070000
2107VU/2 (C7+5915VU/2)	1	021070102
2107VU/3 (C7+5915VU/3)	1	021070104

440x370x170 mm - 3,5 kg

C8 - 2108

technical fabric tool trolley



C8	1	021080000
2108 VU/1 (C8+5915VU/1)	1	021080021

470x370x280 mm - 4 kg

C9 - 2109

technical fabric tool bag

- Hard base
- Interior and exterior tool pockets
- Exterior pocket with zip closure for enhanced safety
- Pocket with strap closure for personal belongings
- Double bottom
- Double string for levels
- Shoulder strap for easier transport



C9	1	021090000
2109 VU/1 (C9+5915VU/1)	1	021090021
2109VU/3 (C9+5915VU/3)	1	021090124

550x280x320 mm - 2,6 kg

C9/RT

shoulder strap for items C4,C7,C9,C10,C10S,C11 and C12



C9/RT	1	021090900
-------	---	-----------

C10 - 2110

technical fabric tool box

- Hard frame
- Double bottom. Bottom can be removed for increased bag capacity
- Tilting handle for easier access to tools
- Elastic tool bands and interior and exterior pockets
- Cover
- Tool tray included in double bottom



C10	1	021100000
2110 VU/1 (C10+5915VU/1)	1	021100021
2110VU/3 (C10+5915VU/3)	1	021100024
2110VU/AS (C10+5915VU/AS)	1	021100026

520x220x250 mm - 3,3 kg

C10S - 2110S

technical fabric tool box

- Hard frame
- Double bottom. Bottom can be removed for increased bag capacity
- Tilting handle for easier access to tools
- Elastic tool bands and interior and exterior pockets
- Cover
- Tool tray included in double bottom



C10S	1	021100001
2110S VU/1 (C10S+5915VU/1)	1	021100101
2110SVU/3 (C10S+5915VU/3)	1	021100104

420x220x250 mm - 2,3 kg

C11 - 2111

technical fabric tool box



C11	1	021110000
2111 VU/1 (C11+5915VU/1)	1	021110101
2111VU/3 (C11+5915VU/3)	1	021110104

400x240x220 mm - 2 kg

Beta

C12 - 2112

technical fabric tool bag

- Removable interior tool panel
- Elastic tool bands and capacious interior and exterior pockets
- Bag opens at front for easier access to tools at workplace
- Hard, waterproof base with rubber feet
- Can be used with trolley C8



C12	1	021120000
2112ET/A (C12+5980ET/A)	1	021120128
2112ET/B (C12+5980ET/B)	1	021120129
2112VU/5 (C12+5915VU/5)	1	021120156

500x370x270 mm - 5 kg

C13

tool trunk with castors,
made of sturdy polypropylene



C13	1	021130000
------------	---	-----------

870x410x350 mm - 7,2 kg

C14

tool trolley, made of polypropylene, with 4 drawers

- Injection polypropylene frame for increased shock resistance.
- Lid-protected front accommodates 4 pull-out drawers (470x255):
 - 1 drawer 30 mm high
 - 2 drawers 60 mm high
 - 1 drawer 90 mm high
- Front centralized lock allows top and front lids to be closed simultaneously.
- Two side handles
- 4 sturdy rear castors
- Removable top tray
- Tool panel built into lid
- 3 tote-trays included
- Nameplate
- Can be closed with TSA lock



C14	1	021140000
2114VU/M (C14+5914VU/M)	1	021140009

580x380x455 mm - 10 kg

CP15 - 2115

tool box, made from plastic, removable tote-tray and tool trays

- 1 tool tray built into cover
- 2 removable tool trays with adjustable partitions
- 1 interior tote-tray with adjustable partitions



CP15	1	021150201
2115PVU/1 (CP15+5915VU/1)	1	021150231
2115PVU/2 (CP15+5915VU/2)	1	021150233

445x240x250 mm - 2 kg



CP15L - 2115

tool box, long series, made from plastic, removable tote-tray and tool trays

- 3 tool trays built into cover with adjustable partitions
- 1 interior tote-tray with adjustable partitions



CP15L	1	021150202
2115PL-VU/1 (CP15L+5915VU/1)	1	021150241
2115PL-VU/3 (CP15L+5915VU/3)	1	021150244

558x277x270 mm - 2,5 kg

2115P L-MQ32

assortment of 32 insulated tools for hybrid cars, in plastic tool box with soft thermoformed tray



2115PL-MQ32	1	021150332
-------------	---	-----------

- 920MQ/55A
- 89MQ 10-12 mm
- 850MQ 1/4"
- 860TX/A10 T7-T8-T9-T10-T15-T20-T25-T27-T30-T40
- 920MQ/A 8-10-12-13-14-17-19 mm
- 920MQ/21 125mm
- 920MQ/22 250mm
- 1048MQ250 250mm
- 1150MQ 180mm
- 1164MQ160 160mm
- 1272MQ 4.5X80-6X100mm
- 1274MQ 3X100-4X100-5.5X125
- 1995MQ/G2 G2
- CP15L

C16 - 2116

tool box, made of plastic, with interior object compartment, empty



C16	1	021160000
2116 VU/1 (C16+5915VU/1)	1	021160101
2116VU/3 (C16+5915VU/3)	1	021160104

500x260x260 mm - 2,5 kg



CP17 - CP17L - 2117

tool box, made of stainless steel and plastic, removable tote-tray



CP17
500x200x220 mm



CP17L
575x245x265 mm

CP17	1	021170500
2117P-VU/1 (CP17+5915VU/1)	1	021170041
2117P-VU/3 (CP17+5915VU/3)	1	021170044
CP17L	1	021170502
2117L-VU/1 (CP17L+5915VU/1)	1	021170141
2117PL-VU/3 (CP17L+5915VU/3)	1	021170144

C18 - 2118

tool box made from sheet metal



C18	1	021180001
2118 VU/1 (C18+5915VU/1)	1	021180031

450x200x100 mm - 3 kg

C19 - 2119 - C19L - 2119L

three-section cantilever tool box, made from sheet metal



C19
450x200x160 mm



C19L
550x200x160 mm

C19	1	021190001
C19L	1	021190002
2119VU/3 (C19+5915VU/3)	1	021190024
2119L-VU/3 (C19L+5915VU/3)	1	021190124



C20 - C20L - 2120

five-section cantilever tool box,
made from sheet metal



C20

450x200x210 mm



C20L

550x200x210 mm

C20	1	021200001
2120 VU/2 (C20+5915VU/2)	1	021200016
2120VU/3 (C20+5915VU/3)	1	021200028
2120 VU/4 (C20+5915VU/4)	1	021200018
2120VU/AS (C20+5915VU/AS)	1	021200021
C20L	1	021200002
2120L-VU/2 (C20L+5915VU/2)	1	021200116
2120L-VU/3 (C20L+5915VU/3)	1	021200128
2120L-VU/4 (C20L+5915VU/4)	1	021200118
2120L-VU/AS (C20L+5915VU/AS)	1	021200121

C22B

tool trunk,
made of sheet metal



C22B O

720x320x310 mm



C22BM O

850x360x350 mm



C22BL O

1010x410x400 mm

C22B-O	1	022000150
C22BM-O	1	022000160
C22BL-O	1	022000170

C22B O: 13 kg
C22BM O: 20 kg
C22BL O: 26 kg

C22P

tool trunk for building yards, made of sheet
metal

built-in, retractable handles
raised shoes for forklift truck handling
double burglar-proof lock closure (not included)



C22PM O

915x540x430 mm



C22PL O

1220x720x615 mm

C22PM-O	1	022000240
C22PL-O	1	022000245

C22PM O: 39 kg
C22PL O: 67 kg

C22W

tool trunk,
made from sheet metal,
lined for enhanced tool protection



C22W O

690x300x360 mm



C22WL O

990x300x360 mm

C22W-O	1	022000269
C22WL-O	1	022000299

C22W O: 15 kg
C22WL O: 28 kg



C22S - 2200S

portable tool chest
with three drawers

Main features:

- Three drawers (588x277 mm)
with ball bearing slides:
- 1 drawer, 50 mm high
- 2 drawers, 70 mm high.
- Front centralized safety lock.
- Retractable side handles for ease of handling.

19 kg



C22S-O



C22S-G



C22S-R



h	max.
50 mm	25 kg
70 mm	25 kg

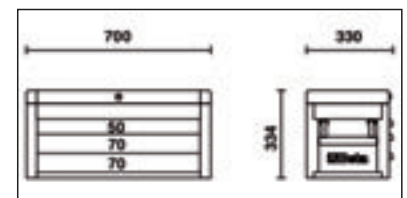
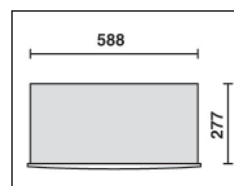

	1	022000501
C22S-O	1	022000501
C22S-G	1	022000502
C22S-R	1	022000503

C23S - 2300S

portable tool chest
with five drawers

Main features:

- Five drawers (588x277 mm)
with ball bearing slides:
- 2 drawers, 50 mm high
- 3 drawers, 70 mm high.
- Front centralized safety lock.
- Retractable side handles for ease of handling.

26 kg



C23S-O



C23S-G



C23S-R



h	max.
50 mm	25 kg
70 mm	25 kg

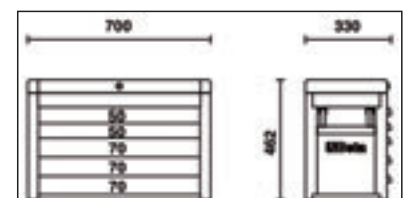
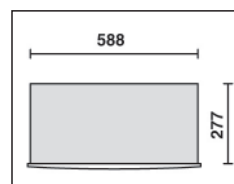

	1	023000501
C23S-O	1	023000501
C23S-G	1	023000502
C23S-R	1	023000503

C23SC - 2300SC

portable tool chest
with eight drawers

Main features:

- Eight drawers with ball bearing slides:
- 4 drawers, 50 mm high
- 3 drawers, 70 mm high
- 1 drawer, 100 mm high.
- Front centralized safety lock.
- Retractable side handles for ease of transport.

28 kg



C23SC-O

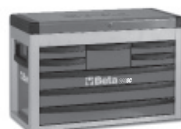

C23SC-G



C23SC-R

h	max
50 mm	25 kg
70 mm	25 kg

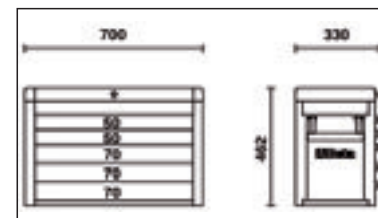
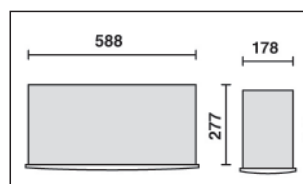

C23SC-O	1	023000511
C23SC-G	1	023000512
C23SC-R	1	023000513

C23ST - 2300ST

portable tool chest
with five drawers

Main features:

- Five drawers (588x367 mm) with ball bearing slides:
- 5 drawers, 70 mm high.
- Front centralized safety lock.
- Can be fitted with kit composed of 4 castors and 1 handle (2300ST/KIT)

36 kg



C23ST-O



C23ST-G



C23ST-R

h	max
70 mm	25 kg

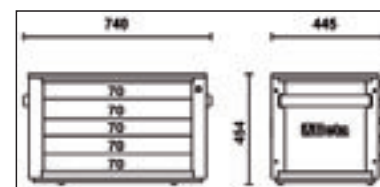
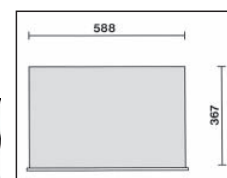

C23ST-O	1	023000521
C23ST-G	1	023000522
C23ST-R	1	023000523

2300ST/KIT

kit with 4 castors and 1 handle for item C23ST

- Four castors 125 mm in Ø:
2 fixed and 2 steering (two with brakes).
- Telescopic handle

6,5 kg

2300ST/KIT

1 023000950



CD23S

Caddy trolley

Main features:

- ABS worktop designed to match tool chests C22S, C23S, C23SC.
- The removable handle can be stored underneath the chassis.
- Four castors 125 mm in Ø:
2 fixed and 2 steering (one with brake).
- Maximum load: 250 kg.

14 kg

CD23S

1 023000610



C04TSS-7

mobile roller cab with seven drawers, made entirely of stainless steel

Main features:

- Seven drawers (570 x 410 mm) with ball bearing slides;
- 6 drawers, 83 mm high;
- 1 drawer, 170 mm high;
- 4 castors Ø 125 mm
2 fixed and 2 steering (two with brakes);
- Front centralized lock;
- Frame made entirely of stainless steel
- Castors, supports, ball bearings, drawer interiors and guides made of stainless steel
- Drawer handles made of aluminium

63 kg

C04TSS/7

1 024003077 226

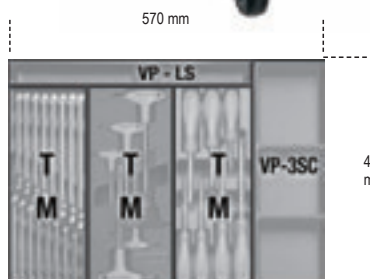

h	max.
83 mm	25 kg
170 mm	30 kg

C24S/5 - 2400S5

mobile roller cab with five drawers

Main features:

- Five drawers (588x367 mm) with ball bearing slides:
 - 2 drawers, 70 mm high
 - 2 drawers, 140 mm high
 - 1 drawer, 280 mm high
- Drawer bases protected by foamed rubber mats.
- Four castors 125 mm in Ø:
 - 2 fixed and 2 steering (one with brake).
- Front centralized safety lock.
- Static load capacity: 800 kg.
- Thermoplastic worktop designed to match tool chests C22S, C23S, C23SC and C23ST
- Integrated side bottle holder.
- Paper roll holder item 2400S-R/PC can also be included.

52 kg



C24S/5-O



C24S/5-G



C24S/5-R

h	max.
70 mm	25 kg
140 mm	30 kg
280 mm	35 kg

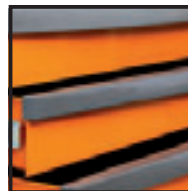

C24S/5-O	1	024002051
C24S/5-G	1	024002052
C24S/5-R	1	024002053

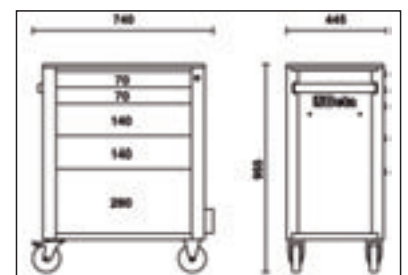
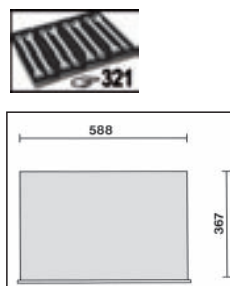

C24S/6 - 2400S6

mobile roller cab with six drawers

Main features:

- Six drawers (588x367 mm) with ball bearing slides:
 - 4 drawers, 70 mm high
 - 1 drawer, 140 mm high
 - 1 drawer, 280 mm high
- Drawer bases protected by foamed rubber mats.
- Four castors 125 mm in Ø:
 - 2 fixed and 2 steering (one with brake).
- Front centralized safety lock.
- Static load capacity: 800 kg.
- Thermoplastic worktop designed to match tool chests C22S, C23S, C23SC and C23ST.
- Integrated side bottle holder.
- Paper roll holder item 2400S-R/PC can also be included.

55 kg

800 kg



C24S/6-O



C24S/6-G



C24S/6-R

h	max
70 mm	25 kg
140 mm	30 kg
280 mm	35 kg

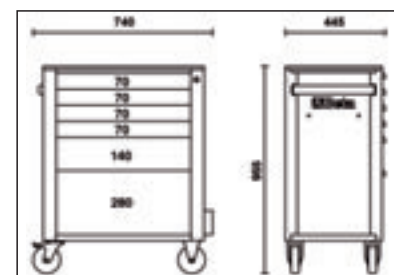
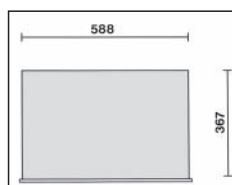
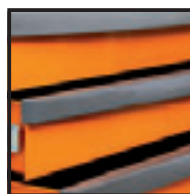

C24S/6-O	1	024002061
C24S/6-G	1	024002062
C24S/6-R	1	024002063

C24S/7 - 2400S7

mobile roller cab with seven drawers

Main features:

- Seven drawers (588x367 mm) with ball bearing slides:
- 5 drawers, 70 mm high
- 1 drawer, 140 mm high
- 1 drawer, 210 mm high
- Drawer bases protected by foamed rubber mats.
- Four castors 125 mm in Ø:
- 2 fixed and 2 steering (one with brake).
- Front centralized safety lock.
- Static load capacity: 800 kg.
- Thermoplastic worktop designed to match tool chests C22S, C23S, C23SC and C23ST
- Integrated side bottle holder.
- Paper roll holder item 2400S-R/PC can also be included.

58 kg



C24S/7-O



C24S/7-G



C24S/7-R

h	max.
70 mm	25 kg
140 mm	30 kg
210 mm	30 kg

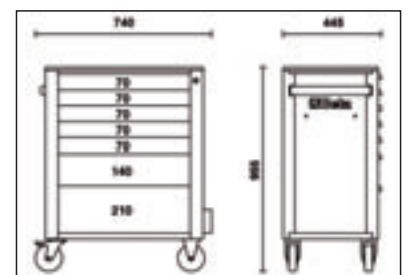
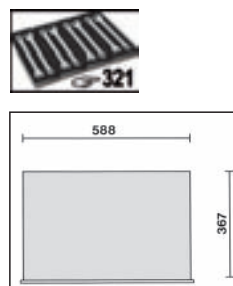

C24S/7-O	1	024002071
C24S/7-G	1	024002072
C24S/7-R	1	024002073

C24S/8 - 2400S8

mobile roller cab with eight drawers

Main features:

- Eight drawers (588x367 mm) with ball bearing slides:
 - 6 drawers, 70 mm high
 - 2 drawers, 140 mm high
- Drawer bases protected by foamed rubber mats.
- Four castors 125 mm in Ø:
 - 2 fixed and 2 steering (one with brake).
- Front centralized safety lock.
- Static load capacity: 800 kg.
- Thermoplastic worktop designed to match tool chests C22S, C23S, C23SC and C23ST.
- Integrated side bottle holder.
- Paper roll holder item 2400S-R/PC can also be included.

61 kg



C24S/8-O



C24S/8-G



C24S/8-R

h	max.
70 mm	25 kg
140 mm	30 kg

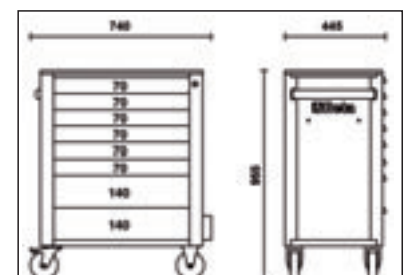
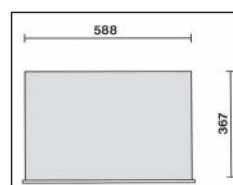

C24S/8-O	1	024002081
C24S/8-G	1	024002082
C24S/8-R	1	024002083

C24SA/6 - 2400SA6

mobile roller cab with six drawers,
with anti-tilt system

Main features:

- Six drawers (588x367 mm), with ball bearing slides:
 - 4 drawers, 70 mm high
 - 1 drawer, 140 mm high
 - 1 drawer, 280 mm high.
- Drawer bases protected by foamed rubber mats.
- Four castors Ø 125 mm:
 - 2 fixed and 2 steering (one with brake).
- Front centralized safety lock.
- Static load capacity: 800 kg.
- Thermoplastic worktop designed to match tool chests C22S, C23S, C23SC and C23ST
- Integrated side bottle holder.
- Paper roll holder item 2400S-R/PC can also be included.

55 kg



C24SA/6-O



C24SA/6-G



C24SA/6-R

h	max.
70 mm	25 kg
140 mm	30 kg
280 mm	35 kg



C24SA/6-O	1	024002161
C24SA/6-G	1	024002162
C24SA/6-R	1	024002163

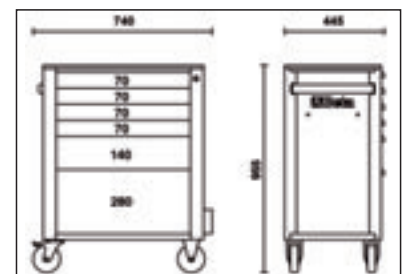
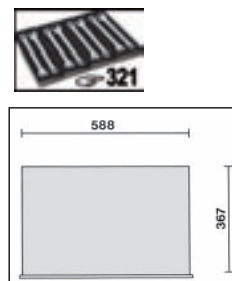

C24SA/7 - 2400SA7

mobile roller cab with 7 drawers,
with anti-tilt system

Main features:

- Seven drawers (588x367 mm) with ball bearing slides:
- 5 drawers, 70 mm high
- 1 drawer, 140 mm high
- 1 drawer, 210 mm high
- Drawer bases protected by foamed rubber mats.
- Does not allow simultaneous opening of several drawers
- Four castors 125 mm in Ø:
- 2 fixed and 2 steering (one with brake)
- Front centralized safety lock
- Static load capacity: 800 kg
- Integrated side bottle holder

58 kg



h	max
70 mm	25 kg
140 mm	30 kg
210 mm	30 kg

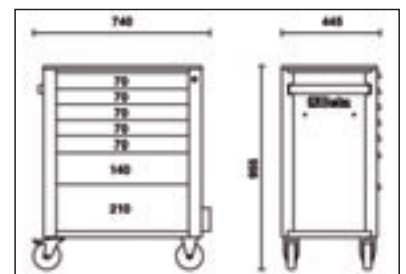
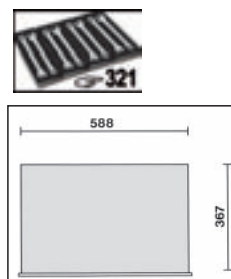

C24SA/7-O	1	024002171
C24SA/7-G	1	024002172
C24SA/7-R	1	024002173

C24SA/8 - 2400SA8

mobile roller cab with eight drawers, with anti-tilt system

Main features:

- 8 drawers (588x367 mm), with ball bearing slides:
- 6 drawers, 70 mm high
- 2 drawers, 140 mm high.
- Drawer bases protected by foamed rubber mats.
- Four castors Ø 125 mm:
- 2 fixed and 2 steering (one with brake).
- Front centralized safety lock.
- Static load capacity: 800 kg.
- Thermoplastic worktop designed to match tool chests C22S, C23S, C23SC and C23ST.
- Integrated side bottle holder.
- Paper roll holder item 2400S-R/PC can also be included.

61 kg



C24SA/8-O



C24SA/8-G



C24SA/8-R

h	max.
70 mm	25 kg
140 mm	30 kg

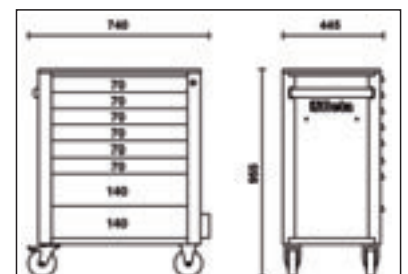
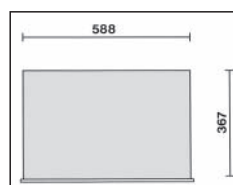

C24SA/8-O	1	024002181
C24SA/8-G	1	024002182
C24SA/8-R	1	024002183

C24SA-XL/7 - 2400SAXL7

mobile roller cab with 7 drawers,
with anti-tilt system,
long model

Main features:

- 7 drawers (882x367) mm, with ball bearing slides:
- 5 drawers, 70 mm high
- 1 drawer, 140 mm high
- 1 drawer, 210 mm high
- Sturdy ABS worktop, with 6 tool trays.
- Sturdy nylon front, with integrated label holder.
- Drawer bases protected by foamed rubber mats.
- Four castors 125 mm in Ø:
- 2 fixed and 2 steering (one with brake).
- Front centralized safety lock.
- Static load capacity: 1,000 kg.
- Integrated side bottle holder.

84 kg

1000
kg



C24SAXL7-O



C24SAXL7-G



C24SAXL7-R

h	max.
70 mm	30 kg
140 mm	35 kg
210 mm	35 kg

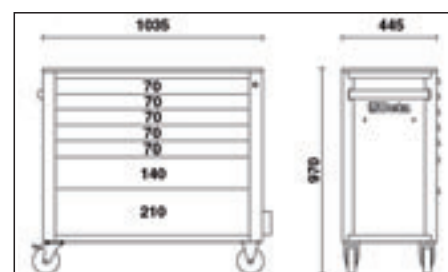
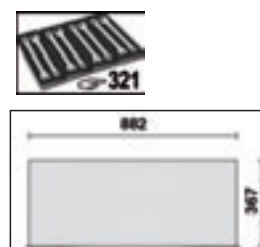

C24SAXL7-O	1	024002271
C24SAXL7-G	1	024002272
C24SAXL7-R	1	024002273

C24SA-XL/8 - 2400SAXL8

mobile roller cab with eight drawers,
with anti-tilt system,
long model

Main features:

- 8 drawers (882x367 mm), with ball bearing slides:
- 6 drawers, 70 mm high
- 2 drawers, 140 mm high.
- Sturdy ABS worktop, with 6 tool trays.
- Sturdy nylon front, with integrated label holder.
- Drawer bases protected by foamed rubber mats.
- Four castors Ø 125 mm:
- 2 fixed and 2 steering (one with brake).
- Front centralized safety lock.
- Static load capacity: 1,000 kg.
- Integrated side bottle holder.
- Paper roll holder item 2400S-R/PC can also be included.

88 kg

1000
kg



C24SAXL/8-O



C24SAXL/8-G



C24SAXL/8-R

h	max.
70 mm	30 kg
140 mm	35 kg



C24SAXL/8-O	1	024002281
C24SAXL/8-G	1	024002282
C24SAXL/8-R	1	024002283

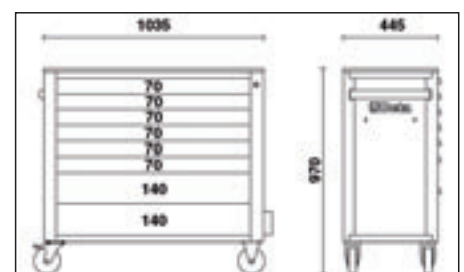

2400S-R/PC

paper roll holder

- Matches roller cabs C24S

0,3 kg

2400SR/PC-O	1	024002951
2400SR/PC-G	1	024002952
2400SR/PC-R	1	024002953



- 2400S R/PC-O
- 2400S R/PC-G
- 2400S R/PC-R



2400S/PF

bottle holder

- Matches roller cabs C24S

0,5 kg

2400S/PF	1	024002906
----------	---	-----------



2499PF

bottle holder

- Can match roller cabs C38, C38A

2,5 kg

2499PF-O	1	024990210
2499PF-G	1	024990219
2499PF-R	1	024990230

2499PF O

2499PF G

2499PF R

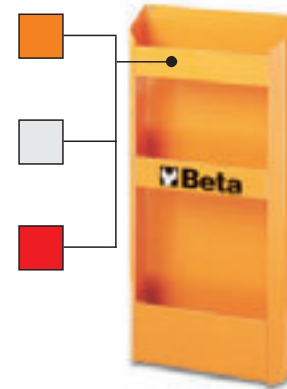

2499PF/M

universal magnetic bottle holder

2,2 kg

2499PF/M	1	024990050
----------	---	-----------



2499PC

paper roll holder

- Matches all Tank and roller cabs and C38, C38A.

2,2 kg

2499PC	1	024990090
--------	---	-----------



C24SL - 2400SL

mobile roller cab
with seven drawers
and side tops

Main features:

- Seven drawers (588x367 mm) with ball bearing slides:
- 5 drawers, 70 mm high
- 1 drawer, 140 mm high
- 1 drawer, 210 mm high.
- Drawer bases protected by foamed rubber mats.
- Four castors 125 mm in Ø:
- 2 fixed and 2 steering (two with brakes).
- Front centralized safety lock.
- Static load capacity: 1.100 kg.
- Multi-ply wood worktop with holes for a vice (1599F/100, to be ordered separately).
- Side compartment with vertically adjustable top.
- Integrated paper roll holder.
- Double rear bottle holder.

80 kg



h	max
70 mm	25 kg
140 mm	30 kg
210 mm	30 kg

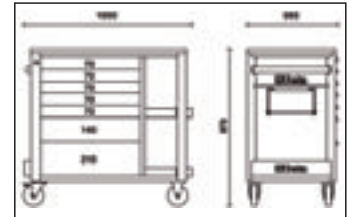
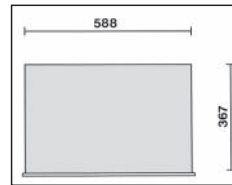

C24SL-O	1	024002101
C24SL-G	1	024002102
C24SL-R	1	024002103

C25 - 2500

Tank trolley with shelf

Main features:

- Foldaway lid.
- 1 sliding drawer.
- Tool tray protected by foamed rubber mats.
- Shelves protected by oil and fuel proof mats.
- Four castors 100 mm in Ø:
- 2 fixed and 2 swivelling (one with brake).
- Safety lock.
- One more shelf M4 can be added on the opposite side.
- Empty thermoformed tray for 1/2" sockets and accessories (024990104).
- Paper roll holder item 2499PC can also be included

31,5 kg

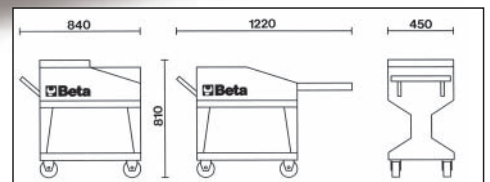

C25	1	025000001
-----	---	-----------

C24SL-CAB

mobile roller cab
with seven drawers
and tool cabinet

Main features:

- Seven drawers (588x367 mm) with ball bearing slides:
- 5 drawers 70 mm high
- 1 drawer 140 mm high
- 1 drawer 210 mm high.
- Drawer bases protected by foamed rubber mats.
- Four castors, Ø 125 mm:
- 2 fixed and 2 steering (two with brakes).
- Front centralized lock.
- Side tool cabinet with lockable door and vertically adjustable interior top.
- Static load capacity: 1,100 kg.
- Multi-ply wood worktop with holes for a vice (1599F/100, to be ordered separately).
- Built-in paper roll holder.
- Double rear bottle holder.

82 kg

1100 kg



C24SL-CAB/O



C24SL-CAB/G



C24SL-CAB/R

h	max.
70 mm	25 kg
140 mm	30 kg
210 mm	30 kg

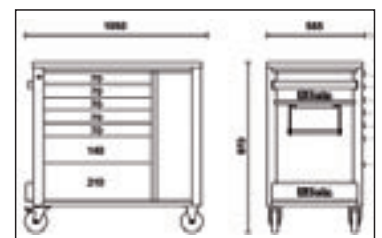
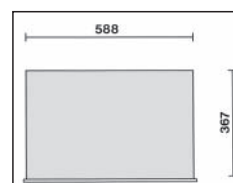

C24SL-CAB/O	1	024002191
C24SL-CAB/G	1	024002192
C24SL-CAB/R	1	024002193

C27S

folding tool trolley for outdoor jobs

Folding tool trolley. Its unique patented design guarantees an effortless transport.

2 drawers, 588x277 mm, with ball bearing slides for two-way opening.

Large lower object compartment, 588x277x220 mm.

Sheet metal frame.

2 fixed castors, Ø 160 mm, and 2 steering castors with brake, Ø 100 mm

Thermoplastic worktop with 6 built-in tool trays.

Centralized lock.

Can accommodate drawer partitions and MC foam tool trays

20 kg



h	max
70 mm	20 kg

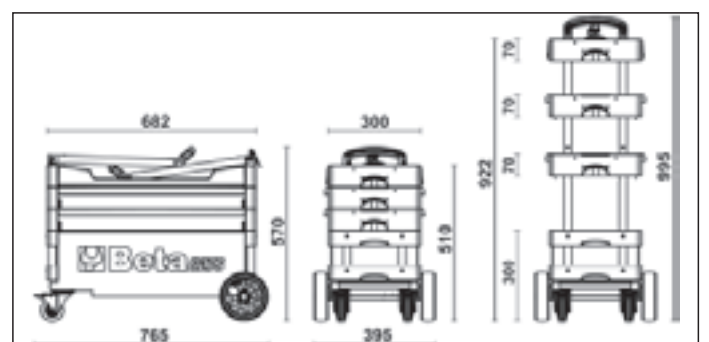
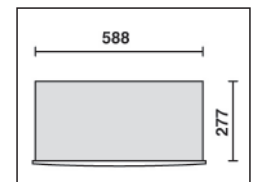

C27S-O	1	027000201
C27S-G	1	027000202
C27S-R	1	027000203

C28 - 2800

SuperTank trolley with worktop and ten drawers

Main features:

- Ten drawers (588x367 mm) with ball bearing slides
- Quick, safe system for opening and closing drawers, with nylon and fibreglass front
- Five side drawers:
 - 4 drawers, 70 mm high
 - 1 drawer, 210 mm high
- Five front drawers:
 - 4 drawers, 70 mm high
 - 1 drawer, 210 mm high
- Drawer bases protected by foamed rubber mats
- Four high-capacity castors 150 mm in Ø:
 - 2 fixed and 2 steering (with brakes)
- 2 centralised safety locks
- Multiply wood worktop with holes for a vice (1599F/150, to be ordered separately)
- 4 bottle holders: 2 front and 2 rear
- 6 side tool trays
- Side compartment with foldaway door with lock
- 135-mm-high storage compartment with plastic-covered base
- Static load capacity: 1200 kg

1200
kg



C28-O

130 kg



C28-G



C28-R



h	max
70 mm	25 kg
210 mm	30 kg

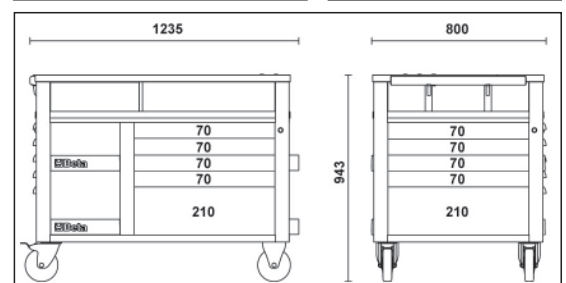
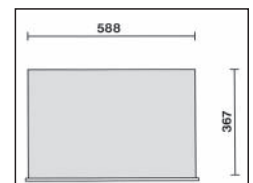

C28-O	1	028000301
C28-G	1	028000302
C28-R	1	028000303

C30S - 3000S

MaxiTank mobile workbench

Main features:

- 5 front drawers with ball bearing slides:
 - 3 drawers (367x588 mm), 90 mm high
 - 1 drawer (610x588 mm), 90 mm high
 - 1 drawer (610x588 mm), 180 mm high.
- Quick opening system with aluminium front.
- Drawer bases protected by foamed rubber mats.
- Can accommodate thermoformed trays.
- One hydraulic jack, designed to lift front part easily.
- Four high-capacity castors:
 - 2 steering, front, Ø 150 mm
 - 2 fixed, rear, Ø 170 mm.
- Oil-proof, rubber-coated worktop, 1300x800 mm, with drain hole for fluid collection in a small tank.
- Can accommodate vice item 1599F/150 (to be ordered separately).
- Storage compartment, 720x250x1300 mm, with PVC-coated worktop, and front sliding panels.
- Centralized lock for drawers and panels.
- Integrated side bottle holders.
- Integrated paper roll holder.
- Static load capacity: 1,800 kg.
- Can accommodate a multi-ply wood worktop (3000 S/PLM), to be ordered separately.
- Can accommodate vice item 1599F/150 (to be ordered separately).

1800 kg



200 kg



h	max.
90 mm	30 kg
180 mm	35 kg

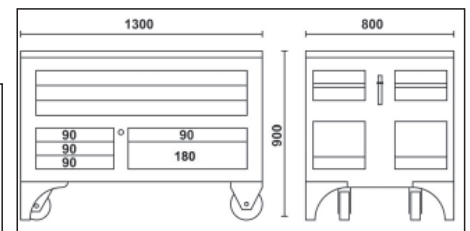

C30S

1 030000100

3000S/PLM

wood worktop for item C30S

10 kg



1240x740x26 mm

3000S/PLM

1 030000150

C33/6

mobile roller cab
with six drawers

Main features:

- Six drawers (588x367 mm) with ball bearing slides:
- Sturdy multi-purpose worktop.
- Tote-trays and holes for accommodating screwdrivers.
- Convenient "V" groove for working pipes and sections.
- Quick release system made of fibreglass-reinforced nylon, opening throughout length of drawer.
- Corner bumpers throughout height of roller cab, to avoid damaging vehicles in garage.
- Drawer bases protected by foamed rubber mats.
- Four castors Ø 125 mm:
- 2 fixed and 2 steering (one with brake).
- Front centralized safety lock.
- Static load capacity: 1000 kg.
- Built-in side bottle and paper holders, adjustable in several positions.

69 kg

1000
kg



C33/6-O



C33/6-G



C33/6-R

h	max.
75 mm	30 kg
150 mm	35 kg
305 mm	40 kg

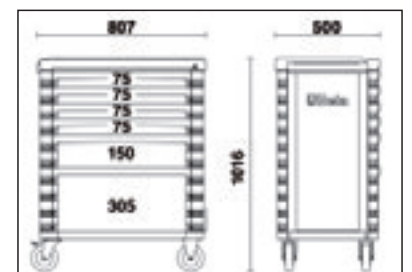
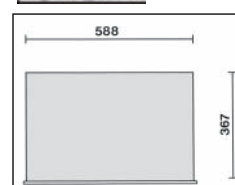

C33/6-O	1	033000261
C33/6-G	1	033000262
C33/6-R	1	033000263

C33/7

mobile roller cab
with seven drawers

Main features:

- Seven drawers (588x367 mm) with ball bearing slides:
- 5 drawers 75 mm high
- 1 drawer 150 mm high
- 1 drawer 225 mm high.
- Sturdy multi-purpose worktop.
- Tote-trays and holes for accommodating screwdrivers.
- Convenient "V" groove for working pipes and sections.
- Quick release system made of fibreglass-reinforced nylon, opening throughout length of drawer.
- Corner bumpers throughout height of roller cab, to avoid damaging vehicles in garage.
- Drawer bases protected by foamed rubber mats.
- Four castors Ø 125 mm:
- 2 fixed and 2 steering (one with brake).
- Front centralized safety lock.
- Static load capacity: 1000 kg.
- Built-in side bottle and paper holders, adjustable in several positions.

1000
kg



C33/7-O

 71 kg



C33/7-G



C33/7-R

h	max
75 mm	30 kg
150 mm	35 kg
225 mm	35 kg

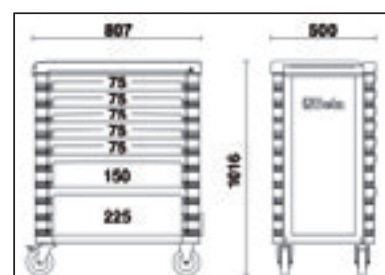
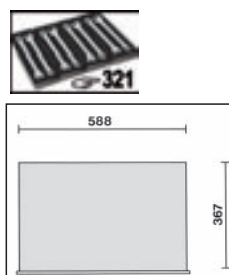

C33/7-O	1	033000271
C33/7-G	1	033000272
C33/7-R	1	033000273

C33/8

mobile roller cab
with eight drawers

Main features:

- Eight drawers (588x367 mm) with ball bearing slides:
- Sturdy multi-purpose worktop.
- Tote-trays and holes for accommodating screwdrivers.
- Convenient "V" groove for working pipes and sections.
- Quick release system made of fibreglass-reinforced nylon, opening throughout length of drawer.
- Corner bumpers throughout height of roller cab, to avoid damaging vehicles in garage.
- Drawer bases protected by foamed rubber mats.
- Four castors Ø 125 mm:
- 2 fixed and 2 steering (one with brake).
- Front centralized safety lock.
- Static load capacity: 1000 kg.
- Built-in side bottle and paper holders, adjustable in several positions.

73 kg

1000
kg



C33/8-O



C33/8-G



C33/8-R

h	max
75 mm	30 kg
150 mm	35 kg

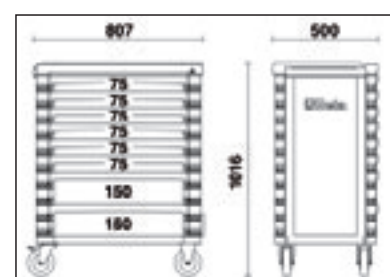
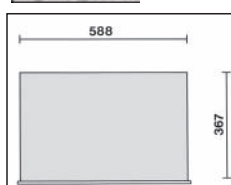

C33/8-O	1	033000281
C33/8-R	1	033000282
C33/8-G	1	033000283

C35/6G

industrial tool chest with six drawers

Main features:

- Six pull-out drawers (600x447 mm):
 - 2 drawers, 75 mm high
 - 1 drawer, 100 mm high
 - 1 drawer, 150 mm high
 - 1 drawer, 200 mm high
 - 1 drawer, 300mm high
- Front centralized safety lock.
- Can accommodate an ABS worktop and drawer partitions, to be ordered separately.



C35/6G

1 035000062

C35/7G

industrial tool chest with seven drawers

Main features:

- Seven pull-out drawers (600x447 mm):
 - 2 drawers, 75 mm high
 - 1 drawer, 100 mm high
 - 3 drawers, 150 mm high
 - 1 drawer, 200 mm high
- Front centralized safety lock.
- Can accommodate an ABS worktop and drawer partitions, to be ordered separately.



C35/7G

1 035000072

C35/8G

industrial tool chest with eight drawers

Main features:

- Eight pull-out drawers (600x447 mm):
 - 4 drawers, 75 mm high
 - 1 drawer, 100 mm high
 - 2 drawers, 150 mm high
 - 1 drawer, 200 mm high
- Front centralized safety lock.
- Can accommodate an ABS worktop and drawer partitions, to be ordered separately.



h	max
75 mm	70 kg
100 mm	70 kg
150 mm	70 kg
200 mm	70 kg

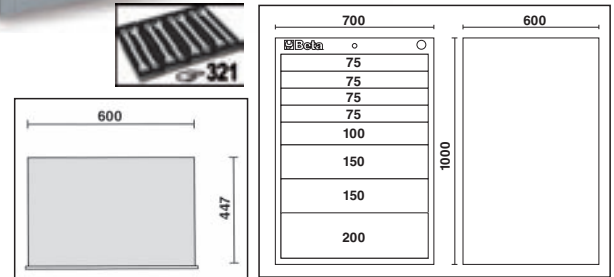

035000082

1 035000082

C35/9G

industrial tool chest with nine drawers

Main features:

- Nine pull-out drawers (600x447 mm):
 - 5 drawers, 75 mm high
 - 1 drawer, 100 mm high
 - 3 drawers, 150 mm high
- Front centralized safety lock.
- Can accommodate an ABS worktop and drawer partitions, to be ordered separately.



h	max
75 mm	70 kg

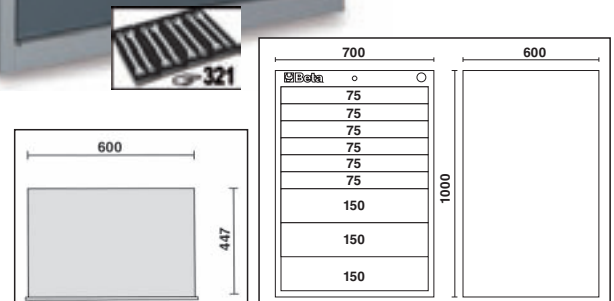

C35/9G

1 035000092

3500/P

Worktop with edge for tool chest C35

3500/P 700x600 mm

1 035000502



3500/D

adapters for drawer C35

Allow dimensions of drawer of tool chest C35 to be adapted, so that all standard foam trays can be used

3500/D

1 035000503



C38 - 3800

mobile roller cab
with eleven drawers

Main features:

- Eleven drawers with ball bearing slides:
- 1 drawer 937x410x122 mm
- 3 drawers 570x410x74 mm
- 2 drawers 570x410x153 mm
- 3 drawers 313x410x74 mm
- 2 drawers 313x410x153 mm.
- Drawer bases protected by foamed rubber mats.
- Static load capacity: 1200 kg.
- 4 high-capacity castors: Ø 125 mm:
- 2 fixed and 2 steering (both with lever brake).
- Front centralized lock.
- Sheet metal worktop covered by a rubber mat.
- Can be fitted with paper roll holder item 2499PC and bottle holder item 2499PF.

114 kg

1200 kg





C38-O



C38-G



C38-R

	
74 mm	25 kg
153 mm	30 kg

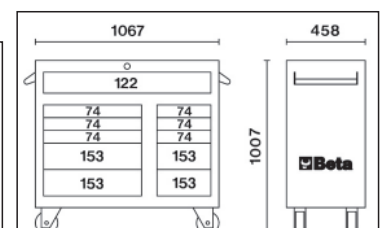
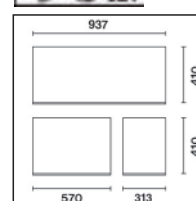

C38-O	1	038000001
C38-G	1	038000003
C38-R	1	038000002

C38L

side cab
with seven drawers

Main features:

- Seven drawers (410x313 mm) with ball bearing slides:
- 5 drawers, 74 mm high
- 2 drawers, 153 mm high
- Drawer bases protected by foamed rubber mats.
- Front centralized safety lock.
- Antislip aluminium worktop.
- Can be placed on both sides of roller cab C38 and C38A.

45 kg

C38L-O	1	038000081
C38L-G	1	038000083
C38L-R	1	038000082



C38L-O



C38L-G



C38L-R

74 mm	25 kg
153 mm	30 kg

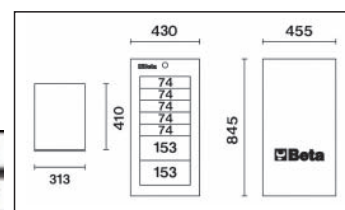

C38L A

side door
with interior shelf

Main features:

- Front lock.
- Vertically adjustable interior shelf.
- Inside door document pocket.
- Antislip aluminium worktop.
- Can be placed on both sides of roller cab C38.

18 kg

C38LA O	1	038000071
C38LA G	1	038000073
C38LA R	1	038000072



C38LA-O



C38LA-G



C38LA-R

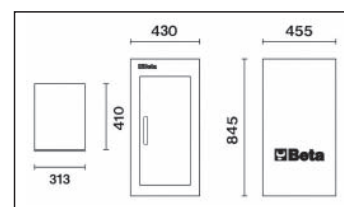

C38T

cab
with eight drawers and top chest

Main features:

- Eight drawers with ball bearing slides:
- 3 drawers 570x410x74 mm
- 1 drawer 570x410x153 mm
- 3 drawers 313x410x74 mm
- 1 drawer 313x410x153 mm.
- Tool compartment.
- Drawer bases protected by foamed rubber mats.
- Front centralized safety lock.
- Antislip aluminium worktop.
- Can be placed on roller cab C38 and C38A.

64 kg

C38T-O	1	038000091
C38T-G	1	038000093
C38T-R	1	038000092



C38T-O



C38T-G



C38T-R

74 mm	25 kg
153 mm	30 kg

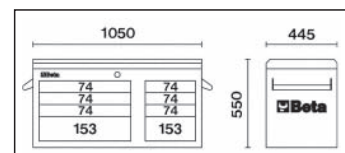
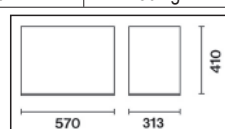

C38C

mobile roller cab
with thirty three drawers,
comprising:

- 1 mobile roller cab C38
- 2 side cabs C38L
- 1 cab C38T with top chest

268 kg



C38C-O



h	max.
74 mm	25 kg
153 mm	30 kg



C38C-G



C38C-R

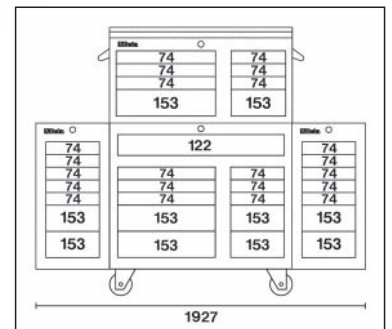
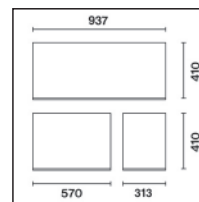

C38C-O	1	038000201
C38C-G	1	038000203
C38C-R	1	038000202

 **Beta**

C39/6 - 3900

mobile roller cab with six drawers

Main features:

- Six drawers (588x367 mm) with ball bearing slides:
 - 4 drawers, 70 mm high
 - 1 drawer, 140 mm high
 - 1 drawer, 280 mm high
- Drawer bases protected by foamed rubber mats.
- Four castors 125 mm in Ø:
 - 2 fixed and 2 steering (one with brake).
- Front centralized safety lock.
- Opening system throughout length of drawer.
- Static load capacity: 1200 kg.
- Thermoplastic worktop.
- Integrated side and rear bottle holders.
- Integrated paper roll holder.
- Uprights and drawer front made of aluminium.

59 kg

1200 kg



C39-6/O



C39-6/G



C39-6/R

h	max.
70 mm	30 kg
140 mm	35 kg
280 mm	40 kg

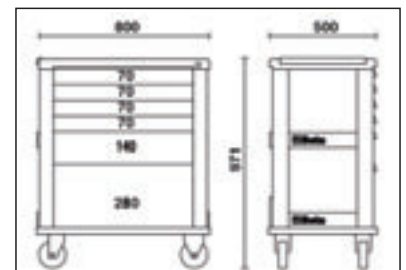
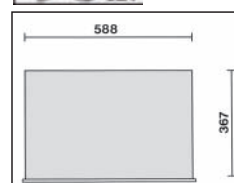

C39-6/O	1	039000031
C39-6/G	1	039000032
C39-6/R	1	039000033

C39/7 - 3900

roller cab
with seven drawers

Main features:

- Seven drawers (588x367 mm) with ball bearing slides:
- 5 drawers, 70 mm high
- 1 drawer, 140 mm high
- 1 drawer, 210 mm high.
- Drawer bases protected by foamed rubber mats.
- Four castors 125 mm in Ø:
- 2 fixed and 2 steering (1 with brake).
- Front centralized safety lock.
- Opening system throughout length of drawer.
- Static load capacity: 1000 kg.
- Thermoplastic worktop.
- Integrated side and rear bottle holders.
- Integrated paper roll holder.
- Uprights and drawer front made of aluminium.

61 kg

1200 kg



C39-7/O



C39-7/G



C39-7/R

h	max.
70 mm	30 kg
140 mm	35 kg
210 mm	35 kg

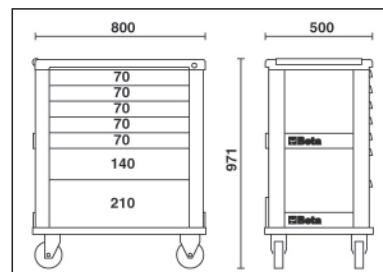
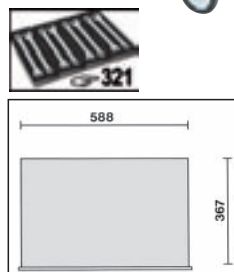

C39-7/O	1	039000001
C39-7/G	1	039000002
C39-7/R	1	039000003

C39/8 - 3900

mobile roller cab with eight drawers

Main features:

- Eight drawers (588x367 mm) with ball bearing slides:
 - 6 drawers, 70 mm high
 - 2 drawers, 140 mm high
- Drawer bases protected by foamed rubber mats.
- Four castors 125 mm in Ø:
 - 2 fixed and 2 steering (one with brake).
- Front centralized safety lock.
- Opening system throughout length of drawer.
- Static load capacity: 1200 kg.
- Thermoplastic worktop.
- Integrated side and rear bottle holders.
- Integrated paper roll holder.
- Uprights and drawer front made of aluminium.

64 kg

1200
kg



C39-8/O



C39-8/G



C39-8/R

h	max
70 mm	30 kg

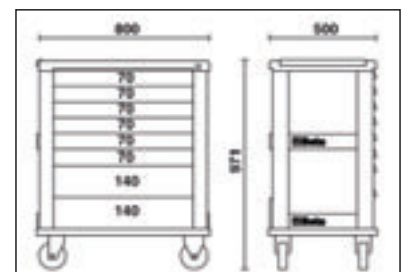
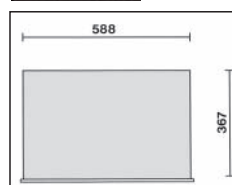

C39-8/O	1	039000041
C39-8/G	1	039000042
C39-8/R	1	039000043

C39T

portable tool chest
with four drawers

Main features:

- Four drawers (588x367 mm) with ball bearing slides:
- 4 drawers, 70 mm high
- Front centralized safety lock.
- Uprights and drawer front made of aluminium.

29 kg



C39T-O

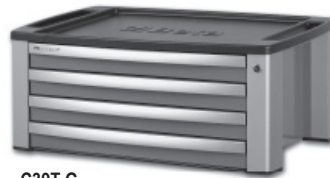

C39T-G



C39T-R

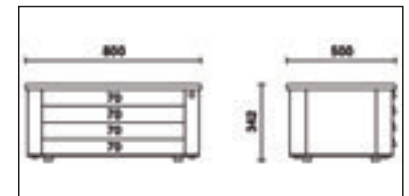
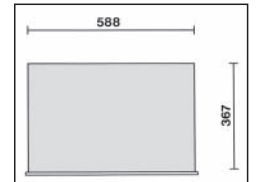
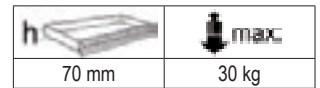

C39T-O	1	039000101
C39T-G	1	039000102
C39T-R	1	039000103



Beta

C39SM

special mobile roller cab, Racing SM type

Specifications

- Multi-ply wood worktop
- 4 castors, Ø 125 mm
- 2 fixed and 2 steering (one with brake), with exposed covering
- Static load capacity: 1200 kg

7-drawer module

588x367 mm, with ball bearing slides:

6 drawers, 70 mm high

1 drawer, 240 mm high

- Drawer bases protected by foamed rubber mats
- Front centralized safety lock
- Opening system throughout length of drawer
- Drawer front made of aluminium

Service module

- Integrated wastepaper basket
- Paper roll compartment
- 1 large drawer (420x305x270 mm)

1200
kg



C39SM-O

125 kg



C39SM-R



C39SM-G



h	max.
70 mm	30 kg
240 mm	40 kg

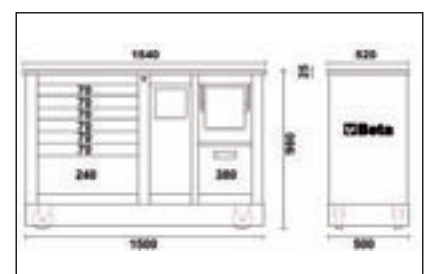
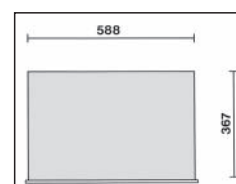

C39SM-O	1	039390001
C39SM-G	1	039390002
C39SM-R	1	039390003

C39MD

special mobile roller cab, Racing MD type

Specifications

- Multi-ply wood worktop
- 4 castors, Ø 125 mm
- 2 fixed and 2 steering (one with brake), with exposed covering
- Static load capacity: 1200 kg

7-drawer module

588x367 mm, with ball bearing slides:

- 6 drawers, 70 mm high
- 1 drawer, 240 mm high
- Drawer bases protected by foamed rubber mats
- Front centralized safety lock
- Opening system throughout length of drawer
- Drawer front made of aluminium

2-drawer module

588x367x270 mm and 588x367x380 mm, with ball bearing slides

- Drawer bases protected by foamed rubber mats
- Front centralized lock
- Opening system throughout length of drawers
- Drawer front made of aluminium

 **1200 kg**



C39MD-O

 **123 kg**



C39MD-R



C39MD-G



h	max.
70 mm	30 kg
240 mm	40 kg

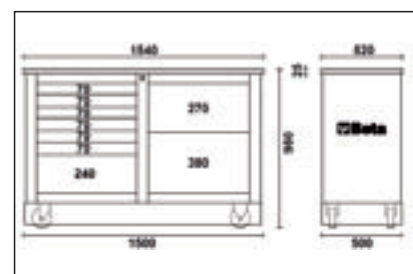
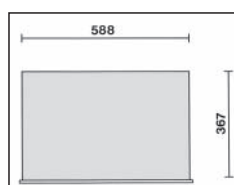

C39MD-O	1	039390101
C39MD-G	1	039390102
C39MD-R	1	039390103

C41S - 4100S

two-module tool trolley

Main features:

- Sheet metal frame and plastic tops, synonymous with remarkable sturdiness and reduced weight.
- 2 detachable modules:
 - 1 upper tool box,
 - 1 module with 2 drawers, 95 mm and 295 mm high respectively.
- Oversized castors (160 mm), built into frame for easy transport - for example, on steps.
- Side centralized lock
- for closing drawers of lower module.
- Drawers with ball bearing slides and double closing hook.
- Telescopic aluminium handle.
- Small tool holder built into upper tool box.
- Lower drawer with double ballbearing slide

Recommended assortments: 5940/SBK and 5915VU/5

16 kg

C41S 1 041000001

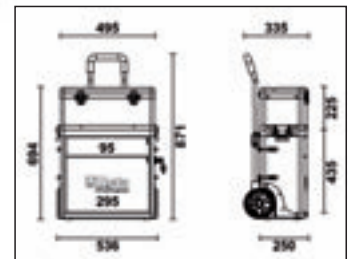

C41H - 4100H

two-module tool trolley

Main features:

- Sheet metal frame and plastic tops, synonymous with remarkable sturdiness and reduced weight.
- 2 detachable modules:
 - 1 upper tool box,
 - 1 module with 2 drawers 95 mm in height,
 - 1 pull-out case made of plastic, 66 mm high, and 1 drawer 295 mm in height.
- Oversized castors (160 mm), built into frame for easy transport - for example, on steps.
- Side centralized lock for closing drawers of lower module.
- Drawers with ball bearing slides and double closing hook.
- Telescopic aluminium handle.
- Small tool holder built into upper tool box.
- Lower drawer with double ballbearing slide

Recommended assortments: 5940/SBK and 5915VU/5

* Colours available on request

21 kg

Model	Color	Weight	Part No.
C41H-O	RAL 2011	1	041000002
C41H-N	RAL 9005	1	041000005
C41H-B	RAL 5002	1	041000006
C41H-R	RAL 3000	1	041000008
C41H-G	RAL 7016	1	041000010
C41H-Y	RAL 1023	1	041000012
C41H-W	RAL 9016	1	041000021
C41H-V	RAL 6016	1	041000024



C41H-O



C41H-W

C41H-Y

C41H-R

C41H-V

C41H-B

C41H-G

C41H-N

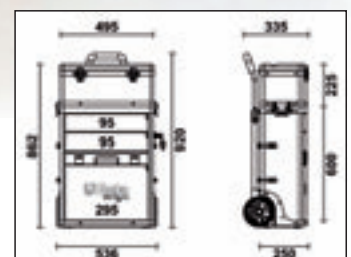

C42S - 4200S

two-module tool trolley

Main features:

- Sheet metal frame and plastic tops, synonymous with remarkable sturdiness and reduced weight.
- 2 detachable modules:
 - 1 upper tool box, 220 mm high
 - 1 lower tool module with castors, 330 mm high.
- Oversized castors (ø 160 mm).
- Telescopic handle, can be adjusted in 3 positions
- Quick module release system: easy, quick access to all compartment tools.
- Upper tool box with interior object compartment and 3 tool trays built into cover.

Recommended assortments: 5940/SBK and 5915VU/5

11,5 kg

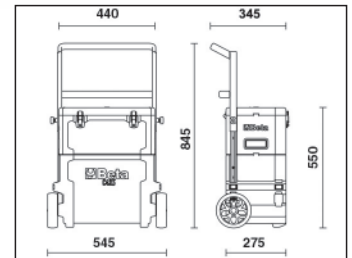

C42S

1 042000001

C42H - 4200H

three-module tool trolley

Main features:

- Sheet metal frame and plastic tops, synonymous with remarkable sturdiness and reduced weight.
- 3 detachable modules:
 - 1 upper tool box, 220 mm high
 - 1 central tool module, 180 mm high.
 - 1 lower tool module with castors, 330 mm high.
- Oversized castors (ø 160 mm).
- Telescopic handle, can be adjusted in 3 positions
- Quick module release system: easy, quick access to all tool compartments.
- Upper tool box with interior object compartment and 3 tool trays built into cover.
- Can be used with 2 modules.

Recommended assortments: 5940/SBK and 5915VU/5

14 kg

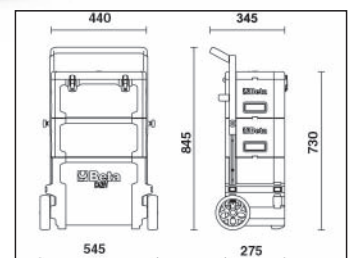

C42H

1 042000002

C41MS

upper module
with built-in small tool holder

3 kg

C41MS	RAL 2011	1	041000904
C41MS/N	RAL 9005	1	041000922
C41MS/B	RAL 5002	1	041000932
C41MS/R	RAL 3000	1	041000942
C41MS/G	RAL 7016	1	041000952
C41MS/Y	RAL 1023	1	041000962
C41MS/W	RAL 6016	1	041000972
C41MS/V	RAL 9016	1	041000982



495x250x225 mm

C41H/CE

tool chest
with removable partitions for small tools,
made from plastic material

1,3 kg

C41H/CE		1	041000916
---------	--	---	-----------



C42 MCH

additional central module for tool trolley item C42

2,5 kg

C42MCH		1	042000105
--------	--	---	-----------



440x180x275 mm



Beta

C51

trolley

- 3 tops covered in antislip ribbed rubber
- Ergonomic handle
- Two fixing options for central worktop
- Four castors Ø 100 mm:
2 fixed and 2 steering (1 with brake)
- Static load capacity: 200 kg (distributed between 3 shelves)

21 kg

C51 O	1	051000001
C51 G	1	051000002
C51 R	1	051000003



CP51

high-grade trolley

- 2 tops covered with rubber mats
- Ergonomic handle
- Four high-grade castors Ø 125 mm:
2 fixed and 2 steering (one with brake).
- Static load capacity: 750 kg (shared by 2 tops)

37 kg

CP51 O	1	051000501
CP51 G	1	051000502
CP51 R	1	051000503



C53 - 5300

CargoEvolution tool cabinets

These tool cabinets are designed according to detailed research and offer accurate, comfortable and rational solutions for end users.

Two perforated panels attached to the doors may be opened giving access to additional storage space.

Main features:

- 1 drawer, with slides.
- Easy tool layout according to users' needs.
- Easy wall mounting by means of two slots located at the back of the cabinet or can be fitted onto the C50 Team trolley, by means of two screws.
- Safety lock for both drawers and doors.
- Empty thermoformed tray for 1/2" sockets and accessories
- Models VI and VG have different toolholder assortments.

41 kg



C53



5300

C53	1	053000001
C53 VI	1	053000090
C53 VG	1	053000095

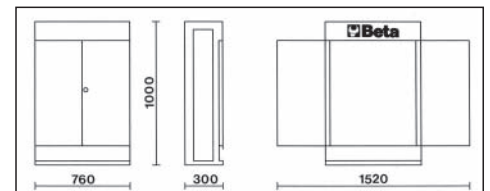

 **Beta**

C54 - 5400

NewCargo cabinets

Same features as item C53.

- Empty thermoformed tray for 1/2" sockets and accessories.
- Single-sided doors.
- Models VI and VG have different toolholder assortments.

33 kg



5400 O



C54 O



C54 G



C54 R

C54 O	1	054000001
C54VI-O	1	054000090
C54VG-O	1	054000095
C54 G	1	054000002
C54VI-G	1	054000092
C54VG-G	1	054000097
C54 R	1	054000003
C54VI-R	1	054000093
C54VG-R	1	054000098

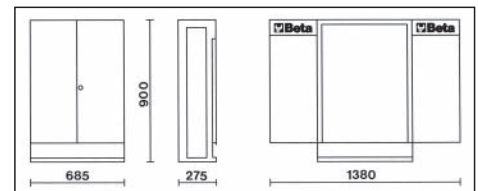

C57SA - 5700SA

MasterCargo workbench

- Model with tool storage board (C57P) and one drawer cabinet.

Drawer cabinet: five drawers, 588x367 mm, 3 90 mm high 1 180 mm and 1 280 mm high, with ball bearing slides.

Can accommodate thermoformed trays. Centralized lock.

Panel tool holder with holes on back for wall mounting. Vertically operated aluminium shutter, with lock.

Three removable perforated panels for supporting tools.

Multi-ply worktop, coated in plastic laminate with three holes for vice item 1599F/150, to be ordered separately.

1800 kg



C57SA O



C57SA G



C57SA R



5700SA A O



398

h	max
90 mm	30 kg
180 mm	40 kg
280 mm	40 kg

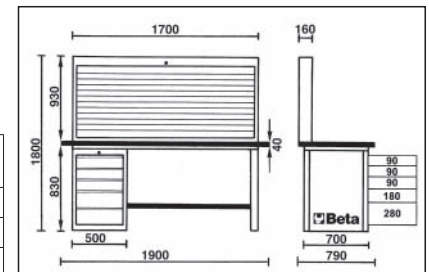

C57S/A-O	1	057001005
C57S/A-G	1	057001205
C57S/A-R	1	057001405

C57SD

MasterCargo workbench

- Model with one drawer cabinet

Drawer cabinet: five drawers, 588x367 mm, 3 90 mm high 1 180 mm and 1 280 mm high, with ball bearing slides.

Can accommodate thermoformed trays. Centralized lock.

Multi-ply worktop, coated in plastic laminate with three holes for vice item 1599F/150, to be ordered separately.

158 kg



C57S D O



398

h	max
90 mm	30 kg
180 mm	40 kg
280 mm	40 kg



C57S D G



C57S D R

C57S/D-O	1	057001004
C57S/D-G	1	057001204
C57S/D-R	1	057001404

C57SB - 5700SB

MasterCargo workbench

- Model with tool storage board (C57P) and two drawer cabinets.

Drawer cabinet: five drawers, 588x367 mm, 3 90 mm high, 1 180 mm and 1 280 mm high, with ball bearing slides. Can accommodate thermoformed trays. Centralized lock.

Panel tool holder with holes on back for wall mounting. Vertically operated aluminium shutter, with lock. Three removable perforated panels for supporting tools.

Multi-ply wood worktop, coated in plastic laminate with three holes for vice item 1599F/150, to be ordered separately.



C57S B O

1800 kg



C57S B G



C57S B R



5700S B O



h	max
90 mm	30 kg
180 mm	40 kg
280 mm	40 kg

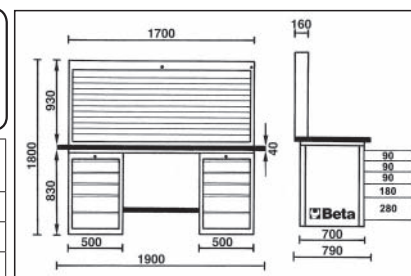

C57S/B-O	1	057001006
C57S/B-G	1	057001206
C57S/B-R	1	057001406

C57SC

MasterCargo workbench

- Model with two drawer cabinets.

Drawer cabinet: five drawers, 588x367 mm, 3 90 mm high, 1 180 mm and 1 280 mm high, with ball bearing slides. Can accommodate thermoformed trays. Centralized lock.

Multi-ply wood worktop, coated in plastic laminate with three holes for vice item 1599F/150, to be ordered separately.



C57S D O



h	max
90 mm	30 kg
180 mm	40 kg
280 mm	40 kg



C57S D G



C57S D R

1800 kg

C57S/C-O	1	057001003
C57S/C-G	1	057001203
C57S/C-R	1	057001403

C57SP - 5700SP

panel tool holder

Panel tool holder with two holes on back for wall mounting.
Aluminium shutter, vertically adjustable, with lock.
Three removable perforated panels for tool holding.

46 kg



C57SP O

1700 mm

930 mm



C57P G



5700SP O/U



C57SP R

398

C57SP-O	1	057001020
C57SP-G	1	057001220
C57SP-R	1	057001420

5700LAMP

MasterCargo workbench lamp

- Sturdy sheet metal frame comprising four elements; provided with screws for assembling the lamp.
- Lamp holder with fluorescent tube, 36W.
- Power supply 230V.
- Provided without wire.

9 kg



5700LAMP + 5700SA O

5700 LAMP

1 057000005

C58P - 5800P

panel toolholder

- Security locked shutter.

 31 kg



C58P O

1140 mm

930 mm



C58P G



5800UP/O



C58P R



398

		
C58P-O	1	058000121
C58P-G	1	058000122
C58P-R	1	058000123

PV

wall tool panel





A

L



398

	LxA mm	 kg		
PV1	1000x920	10,2	1	088880010
PV1,5	1500x920	14,2	1	088880015

C56W

workbench with wood top

- Multi-ply wood worktop (30 mm thick)
- Steel frame with 6 supporting legs
- Static load capacity: 1,200 kg
- Matches panel tool holder C57P; cannot be fixed to worktop.
- Two drawers with locks.
- Can be fixed to floor.

86 kg



C56W-O	1	056000251
C56W-G	1	056000252
C56W-R	1	056000253

C56

workbench

- Worktop made of painted sheet metal with external edge
- Steel frame with 6 supporting legs
- Static load capacity: 1200 kg
- Matches panel toolholder C57P; cannot be fixed to worktop
- Two drawers with lock
- Can be fixed to floor

82 kg



C56-O	1	056000201
C56-G	1	056000202
C56-R	1	056000203

C56M

workbench

- Worktop made from both slip-proof aluminium sheet and rubber mat.
- Load capacity: kg.800.
- Can match panel toolholder C57P.
- Three drawers with lock.
- Can be fixed to the floor.

95 kg



C56M O	1	056000050
C56M G	1	056000053
C56M R	1	056000054

C58M

workbench

- Metal worktop fully covered with a removable antislip rubber mat.
- Lower shelf made from solid wood.
- Static load capacity: 800 kg.
- Can match panel tool holder C58P; cannot be fixed to the worktop.
- 2 drawers with locks.
- Can be fixed to the floor.
- Aluminium worktop item C58M/PA available on request.

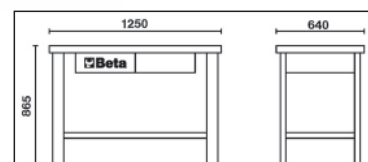

📦 65 kg

Item	QTY	Part No.
C58M-O	1	058000300
C58M-G	1	058000302
C58M-R	1	058000303

C58M/PA

knurled aluminium worktop for workbench item C58M

📦 4,5 kg



Item	QTY	Part No.
C58M/PA	1	058000350

C59A - 5900A

"Endurance" workbench with 1 cab with six drawers

Main features:

- Worktop made from multi-ply wood with holes for vice item 1599F/125 (to be ordered separately).
- 6 drawers (588x367 mm) with ball bearing slides:
 - 4 drawers, 70 mm high
 - 1 drawer, 140 mm high
 - 1 drawer, 280 mm high.
- Drawers protected by foamed rubber mats.
- Hard-wearing nylon drawer front.
- Roller cabs can accommodate thermoformed trays.
- Front centralized safety lock.
- Lower object shelf.
- Can be fitted with paper roll holder (2400S-R/PC) and bottle holder (2400S/PF), to be ordered separately.

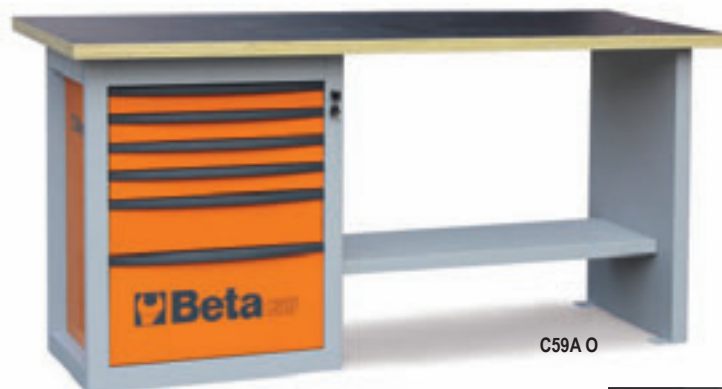

C59A O



📦 115 kg

Item	QTY	Part No.
C59A-O	1	059000001
C59A-G	1	059000021
C59A-R	1	059000041

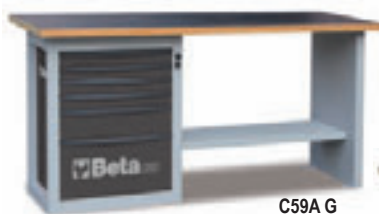

C59A G

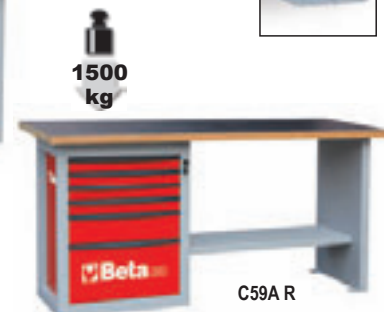

C59A R



h	max
70 mm	25 kg
140 mm	30 kg
280 mm	35 kg



C59B - 5900B

"Endurance" workbench with 2 cabs with six drawers

Main features:

- Worktop made from multi-ply wood with holes for vice item 1599F/125 (to be ordered separately).
- 12 drawers (588x367 mm) with ball bearing slides:
8 drawers, 70 mm high
2 drawers, 140 mm high
2 drawers, 280 mm high.
- Drawers protected by foamed rubber mats.
- Can accommodate thermoformed trays.
- Front centralized safety lock.
- Lower object shelf.
- Can be fitted with paper roll holder (2400S-R/PC) and bottle holder (2400S/PF), to be ordered separately.



C59B O



C59B G



C59B R



1500
kg

155 kg

	1	059000002
C59B-O	1	059000002
C59B-G	1	059000022
C59B-R	1	059000042

h	max
70 mm	25 kg
140 mm	30 kg
280 mm	35 kg

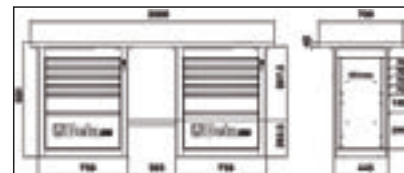

C59C - 5900C

"Endurance" workbench with 1 cab with six drawers, short model

Main features:

- Worktop made from multi-ply wood with holes for vice item 1599F/125 (to be ordered separately).
- 6 drawers (588x367 mm) with ball bearing slides:
4 drawers, 70 mm high
1 drawer, 140 mm high
1 drawer, 280 mm high.
- Drawers protected by foamed rubber mats.
- Can accommodate thermoformed trays.
- Front centralized safety lock.
- Lower object shelf.
- Can be fitted with paper roller holder (2400S-R/PC) and bottle holder (2400S/PF), to be ordered separately.



C59C O

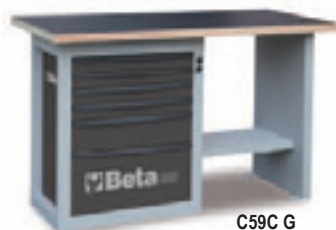

C59C G



C59C R



1500
kg

105 kg

	1	059000003
C59C-O	1	059000003
C59C-G	1	059000023
C59C-R	1	059000043

h	max
70 mm	25 kg
140 mm	30 kg
280 mm	35 kg

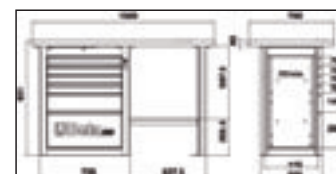

Beta

RSC55



Modularity

Modular garage fitting your spaces and requirements

Quality

Beta's best Italian-made quality to furnish your garage

Design

Refined, captivating finishes for a tidy, attractive workstation

Organization

A sensibly organized workstation, synonymous with optimized work

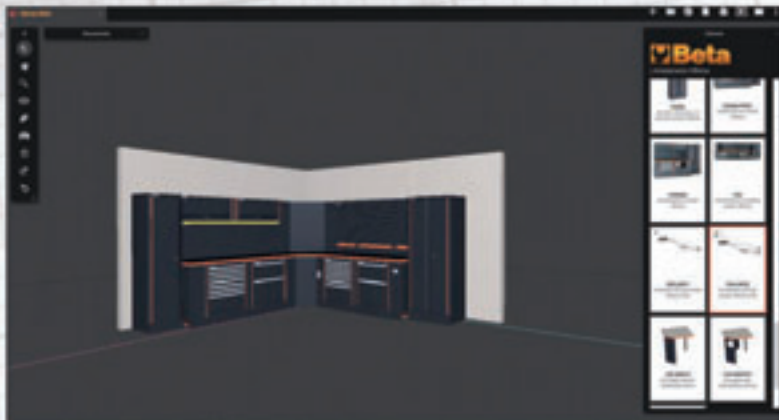
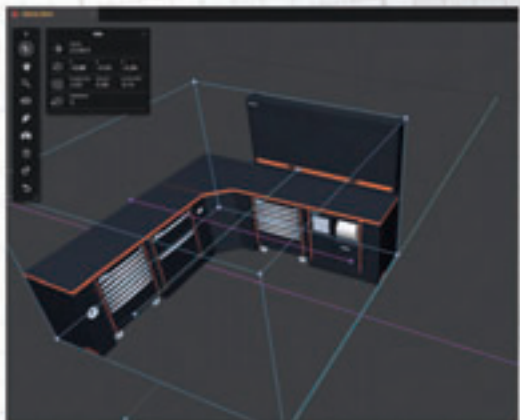

Configure your workshop online

Go to www.beta-tools.com/RSC55en

WORKSHOP EQUIPMENT

To answer the requirements of a market where the emphasis is increasingly on quality, design and customization, Beta Utensili has developed "Racing System C55", modular garage furniture shaped on your needs, while allowing you to create a modern work environment.



Your colours for your workshop!

RSC55 allows you to order the benches and tool wall system with shutter in a neutral (grey) version and customize the vertical coloured inserts by choosing from 7 different adhesive tapes.

1. Order your modules in a neutral colour

2. Order the vertical insert

Choose the colour to your taste or according to your company's colours



C55

comprehensive workshop equipment combination



Comprehensive combination comprising:

- Single-door tool cabinet (C55A1)
- Two-door tool cabinet (C55A2)
- Workbench (C55BO/2)
- Workbench with sockets (C55PRO BO/2)
- Mobile roller cab with 7 drawers (C55C7)
- Fixed module with 2 storage drawers (C55M2)
- Fixed module with 7 drawers (C55M7)
- Fixed service module (C55MS)
- Tool panel with suspended cabinets (C55/2PM)
- Tool panel with shutter (C55PS-O)

C55AB

workshop equipment combination

Combination comprising:

- Two-door tool cabinet (C55A2)
- Workbench (C55BO/2)
- Fixed module with 7 drawers (C55M7)
- Fixed service module (C55MS)
- Tool panel with suspended cabinets (C55/2PM)

407 kg



C55AB

1 055000020



C55PB/3

workshop equipment combination

Combination comprising:

- Workbench (C55BO/2)
- Fixed module with 8 drawers (C55M8)
- Fixed module with 2 storage drawers (C55M2)
- Wall tool system with shutter (C55PS-O)

334 kg



C55PB/3

1 055000035



C55B/2

2-m-long workbench, for workshop equipment combination

With worktop (2050x700 mm) covered with a shockproof, non-scratch PVC coat, resistant to hydrocarbons

- Holes for a vice (1599F/150, to be ordered separately)
- Vertically adjustable feet

100 kg

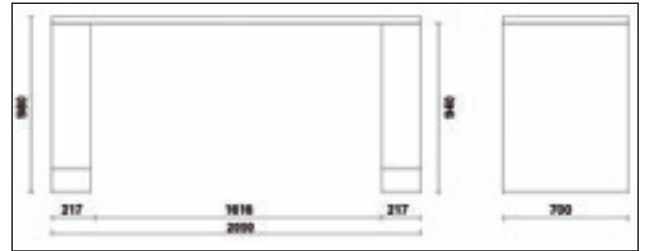
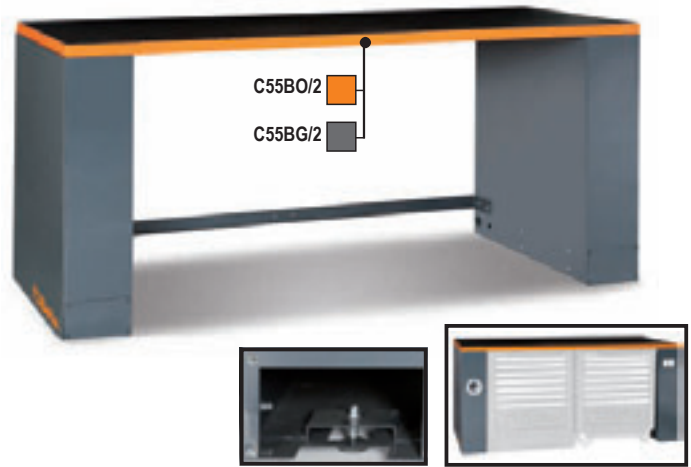

C55BO/2	1	055000101
C55BG/2	1	055000111

C55PRO B/2

2-m-long workbench, for workshop equipment combination

With worktop (2050x700 mm) covered with a shockproof, non-scratch PVC coat, resistant to hydrocarbons

Built-in sockets and roller:

- Schuko socket+16+10A
- EU Plug 16+10A
- Compressed air outlet and roller, Ø 8 mm. Length: 10 mm
- Holes for a vice (1599F/150, to be ordered separately)
- Vertically adjustable feet

105 kg

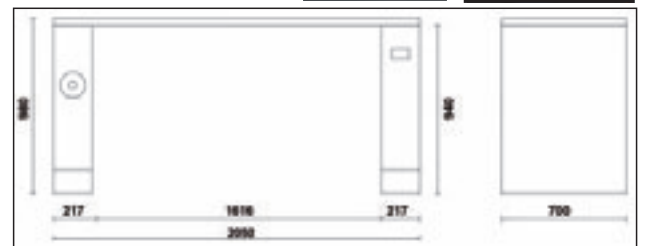
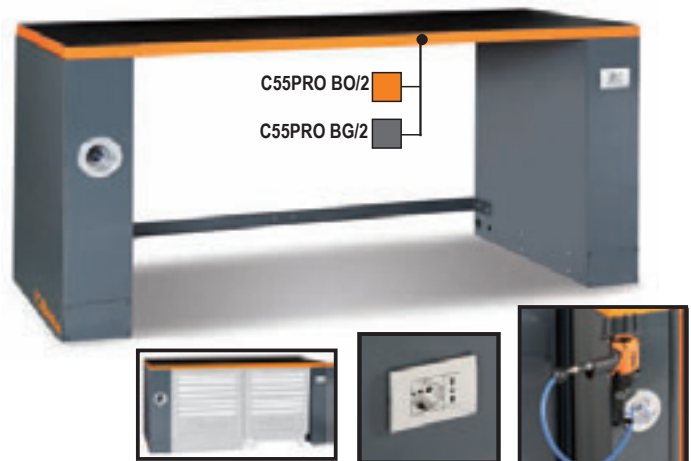

C55PRO BO/2	1	055000151
C55PRO BG/2	1	055000171

Beta

C55B/2,8

2.8-m-long workbench, for workshop equipment combination

Worktop (2850x700 mm) covered with a shockproof, non-scratch PVC coat, resistant to hydrocarbons

- Holes for a vice (1599F/150, to be ordered separately)
- Vertically adjustable feet

122 kg

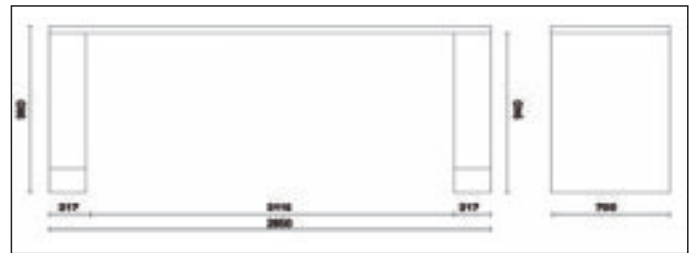
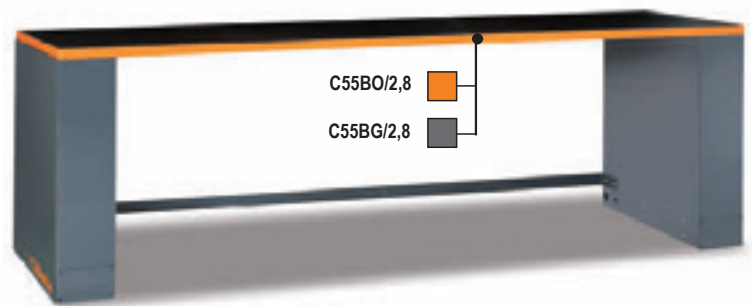

C55BO/2,8	1	055000261
C55BG/2,8	1	055000281

C55PRO B/2,8

2.8-m-long workbench, for workshop equipment combination

Worktop (2850x700) covered with a shockproof, non-scratch PVC-coat, resistant to hydrocarbons

Built-in sockets and roller:

- Schuko socket+16+10A
- Plug 16+10A
- Compressed air outlet and roller Ø 8 mm. Length: 10 m
- Holes for a vice (1599F/150, to be ordered separately)
- Vertically adjustable feet

127 kg

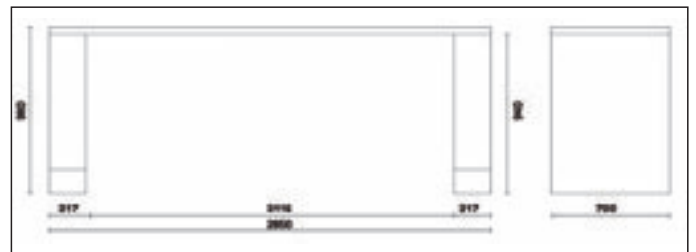
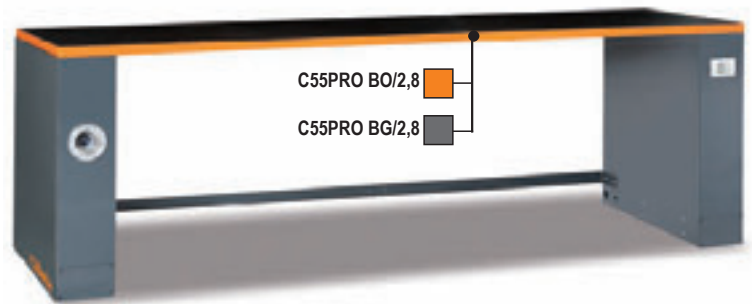

C55PRO BO/2,8	1	055000271
C55PRO BG/2,8	1	055000283

C55B PT/2

2-m-long worktop, for workshop equipment workbench

Painted sheet metal worktop (2050x700 mm) covered with a shockproof, non-scratch PVC coat, resistant to hydrocarbons

With rear crossbar for fixing modules

Holes for a vice (1599F/150, to be ordered separately)

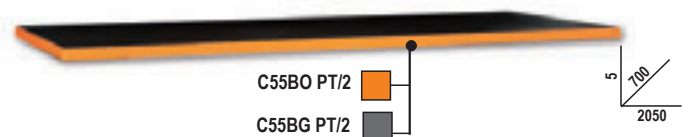

C55B PT/2	1	055000106
C55BG PT/2	1	055000116

C55B PT/2,8

2.8-m-long worktop, for workshop equipment workbench

Painted sheet metal worktop (2850x700 mm) covered with a shockproof, non-scratch PVC coat, resistant to hydrocarbons

With rear crossbar for fixing modules

Holes for a vice (1599F/150, to be ordered separately)



61 kg

C55BO PT/2,8	1	055000266
C55BG PT/2,8	1	055000286

C55B/GD

plain right leg for workshop equipment workbench

With vertically adjustable feet

28 kg

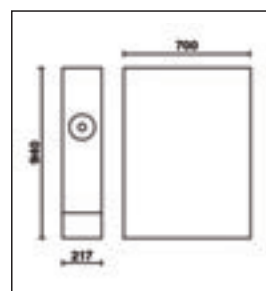

C55B/GD	1	055000104
---------	---	-----------

C55B/GS

plain left leg for workshop equipment workbench

With vertically adjustable feet

28 kg

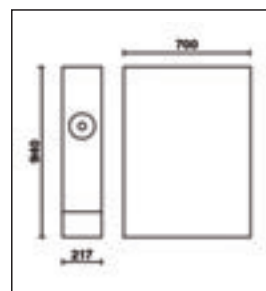

C55B/GS	1	055000105
---------	---	-----------

C55B/GDE

right leg with power sockets for workshop equipment workbench

With Schuko socket +16+10A and EU Plug 16+10A

With vertically adjustable feet

28 kg

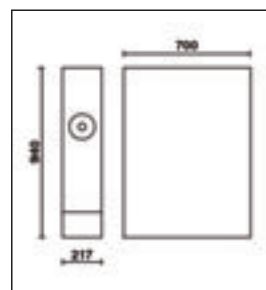

C55B/GDE	1	055000154
----------	---	-----------

C55B/GSE

left leg with power sockets for workshop equipment workbench

With Schuko socket +16+10A and EU Plug 16+10A
With vertically adjustable feet

📦 28 kg

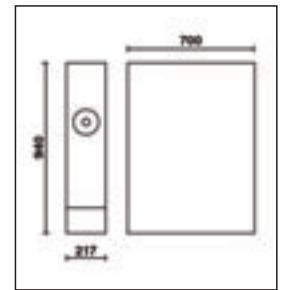

C55B/GSE

1 055000165

C55B/GDAA

right leg with built-in roller for workshop equipment workbench

Built-in roller, Ø 8 mm. Length: 10 m
With vertically adjustable feet

📦 33 kg

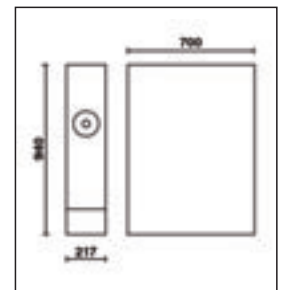

C55B/GDAA

1 055000166

C55B/GSAA

left leg with built-in roller for workshop equipment workbench

Built-in roller, Ø 8 mm.
Length: 10 m
With vertically adjustable feet

📦 33 kg

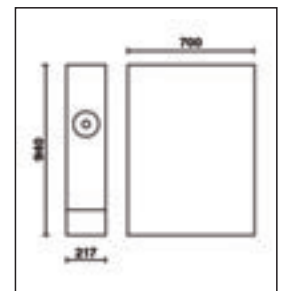

C55B/GSAA

1 055000156

C55B/GDS

double leg for adjoining workshop equipment workbenches

Compartment with slide-away door, 365x750 mm
With vertically adjustable feet

📦 37 kg

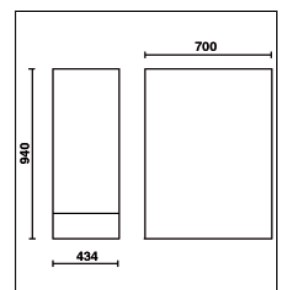

C55B/GDS

1 055000291

C55C7

mobile roller cab with seven drawers, for workshop equipment combination

- 7 drawers (588x367 mm), with ball bearing slides
- 4 castors Ø 100 mm, 2 fixed (one with brake) and 2 steering
- Aluminium opening system throughout length of drawer
- Drawer bases protected by foamed rubber mats
- Front centralized lock
- Can be fitted with foam trays

79 kg



h	max
70 mm	30 kg
245 mm	40 kg

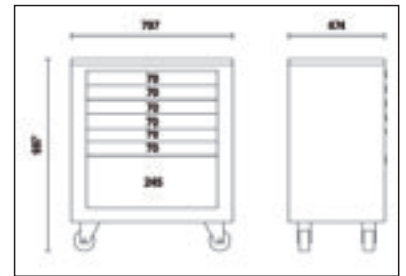
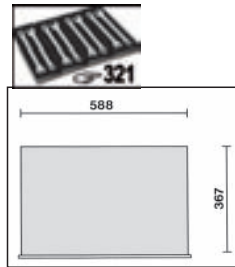

C55C7

1 055000201

C55C8

roller cab module with eight drawers, for workshop equipment combination

- 8 castors (588x367 mm) with ball bearing slides
- 4 castors Ø 100 mm, 2 fixed (one with brake) and 2 steering
- Aluminium opening system throughout length of drawer
- Drawer bases protected by foamed rubber mats
- Front centralized lock
- Can be fitted with foam trays

81 kg



h	max
70 mm	30 kg

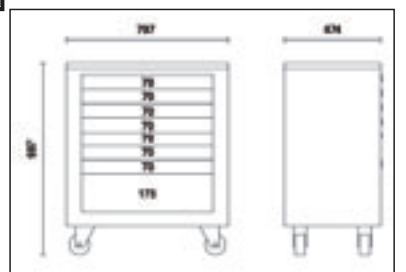

C55C8

1 055000206

C55M7

fixed module with seven drawers, for workshop equipment combination

- 7 drawers (588x367 mm) with ball bearing slides
- Aluminium opening system throughout length of drawer
- Drawer bases protected by foamed rubber mats
- Front centralized lock
- Can be fitted with foam trays

📦 78 kg



h		
	70 mm	30 kg

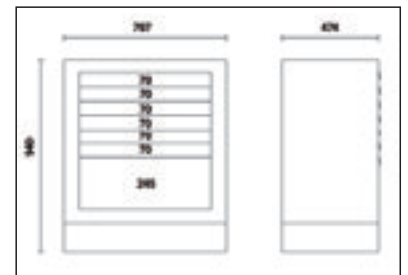
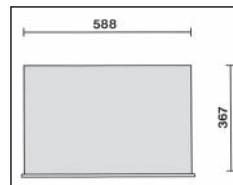

C55M7

📦 1 055000203

C55MS

fixed service module, for workshop equipment combination

- Built-in waste bin
- Perforated paper roll compartment
- Storage drawer, 305x270 mm

📦 75 kg

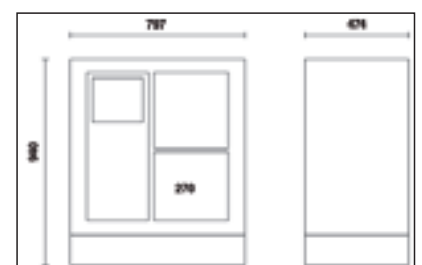

C55 MS

📦 1 055000204

C55MA

fixed two-door module, for workshop equipment combination

- With lock
- Interior shelf, vertically adjustable

75 kg

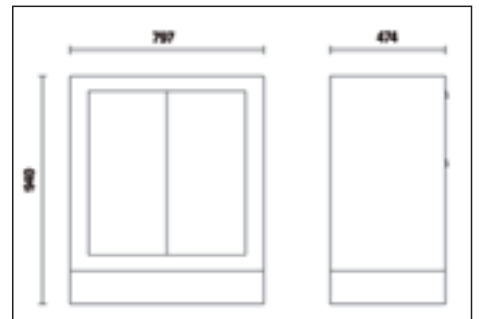

C55 MA

1 055000205

C55M2

fixed module with 2 drawers, for workshop equipment combination

- 2 drawers (588x367mm) with ball bearing slides
- Aluminium opening system throughout length of drawer
- Drawer bases protected by foamed rubber mats
- Front centralized lock

66 kg

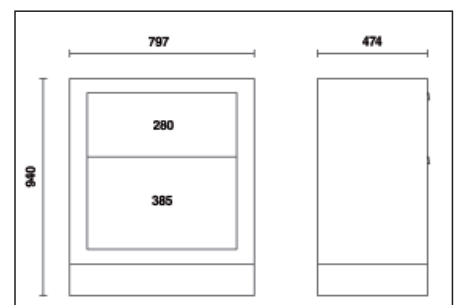

C55 M2

1 055000202

C55PS

tool wall system with shutter, for workshop equipment combination

- Aluminium shutter, vertically adjustable, with lock
- Removable perforated tool panel
- Supplied with framework
- 50-hook GPS kit included
- Matches 2-m-long workbench

88 kg



C55PS-O	1	055000250
C55PS-G	1	055000255

C55/2PM

tool wall system with 2 suspended cabinets, for workshop equipment combination

- 2 suspended cabinets, 1024x400x300 mm, fitted with gas springs, making it easier to open and close doors.
- Wall panel, 2050x620 mm; can accommodate perforated tool panels C55/2PF (to be ordered separately)
- Supplied with framework
- Matches 2-m-long workbench

80 kg



C55 2PM	1	055000301
---------	---	-----------

C552PF

2 perforated tool panels, for workshop equipment combination

- 2 perforated tool panels, 1024x600 mm
- Matches item C55/2PM

12 kg



C55 2PF	1	055000310
---------	---	-----------

C55PP

tool wall system with shutter and suspended cabinet, for workshop equipment combination

- Aluminium shutter, vertically adjustable, with lock
- Tool cabinet fitted with gas springs, making it easier to open and close doors
- Wall panel can accommodate perforated tool panels C55/1PF (to be ordered separately)
- Supplied with framework to match 2.8-m-long workbenches

157 kg

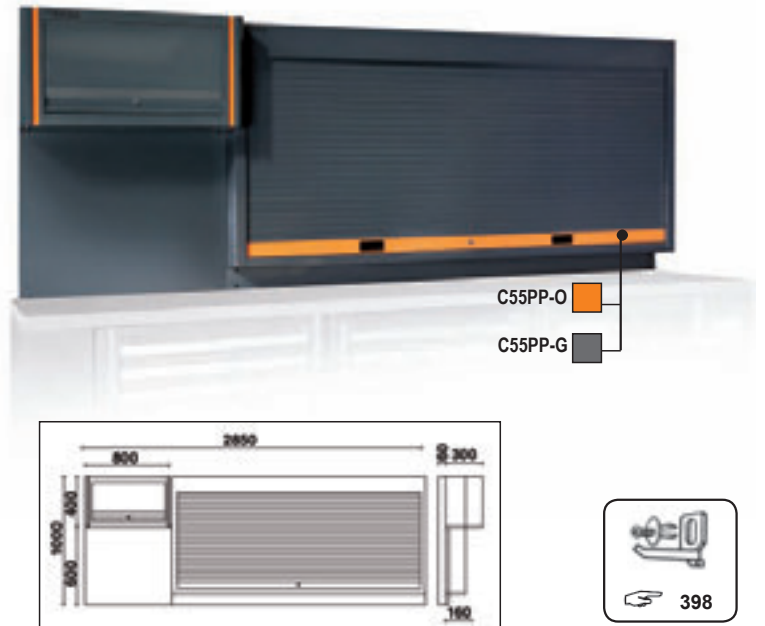

C55PP-O	1	055000350
C55PP-G	1	055000355

C55/1PF

perforated tool panel, for workshop equipment combination

- Perforated tool panel (800x600 mm)
- Matches framework C55PP

5 kg



C55/1PF	1	055000309
---------	---	-----------

C55/3PM

tool wall system with 3 suspended cabinets, for workshop equipment combination

- 3 suspended cabinets fitted with gas springs, making it easier to open and close doors
- Wall panel can accommodate perforated tool panels C55/3PF (to be ordered separately)
- Supplied with framework to match workbenches

132 kg

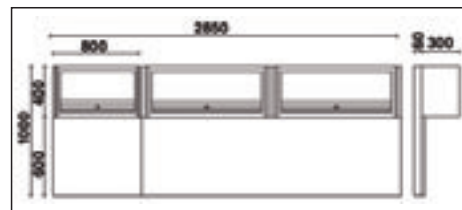

C55/3PM	1	055000300
---------	---	-----------

C55/3PF

3 perforated tool panels, for workshop equipment combination

- 2 perforated tool panels (1024x600 mm) and 1 panel 800x600 mm
- Matches framework C55/3PM

17 kg



C55/3PF	1	055000308
---------	---	-----------

C55AN

interior angle for workshop equipment combination

34,9 kg

C55AN/PS
055000191

C55AN-O
055000181

C55AN-G
055000183

C55AN-O	1	055000181
C55AN-G	1	055000183
C55AN/PS	1	055000191

C55AN-PC

interior angle for workshop equipment combination, with paper roll compartment

39,6 kg

C55AN/PS
055000191

C55AN-O/PC
055000182

C55AN-G/PC
055000184

C55AN-O/PC	1	055000182
C55AN-G/PC	1	055000184
C55AN/PS	1	055000191

The Beta logo features a stylized orange icon of a person's head and shoulders, followed by the word "Beta" in a bold, orange, sans-serif font. The background is a light gray grid with faint technical drawings of mechanical parts.

C55A1

sheet metal single-door tool cabinet, for workshop equipment combination

- 3 removable, vertically adjustable shelves
- With lock
- Usable interior dimensions: 177x42x42 cm

50 kg



C55A1



1 055000411

C55A1/R42

interior shelf for tool cabinet C55A1

2,4 kg

	mm	C55A1		
C55A1/R42	400x420	← 2017	1	055000451
C55A1/R42	400x400	2018 →	1	055000461



C55A2

sheet metal two-door tool cabinet, for workshop equipment combination

- 3 removable, vertically adjustable shelves
- With lock
- Usable interior dimensions: 177x70x42 cm

72 kg



C55A2

1 055000412

C55A2/R70

interior shelf for tool cabinet C55A2

3,5 kg

	mm	C55A2		
C55A2/R70	700x420	← 2017	1	055000452
C55A2/R70	700x400	2018 →	1	055000462

C55RB

scratch-proof PVC coat resistant to hydrocarbons

Worktop protection.

C55RB/2: for 2-m-long workbench C55RB/2.8: for 2.8-m-long workbench

C55RB/AN: for interior angle



C55RB/2	1	055000195
C55RB/2,8	1	055000196
C55RB/AN	1	055000197

C55LMP/1

LED lamp for workshop equipment combination

- Length: 1 m
- Easy to fix under wall cabinet through a pair of magnets
- ON/OFF switch
- Built-in cable and transformer, 25 W
- 1300 lumens



C55LMP/1

1 055000320

C55LMP/2

2 LED lamps for workshop equipment combination C55

- length: 2 1-m-long lamps, connected to each other
- Easy to fix under cabinet through a pair of magnets
- ON/OFF switch
- Built-in cable and transformer, 18 W
- 1300 lumens

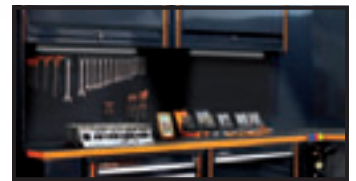

2 kg

C55LMP/2

1 055000322

C55STR

adhesive tape 25 m

allows to tailor the vertical tapes of garage furniture item C55



C55STR-O/2011		1	055000901
C55STR-R/3000		1	055000903
C55STR-V/6029		1	055000906
C55STR-W/9016		1	055000907
C55STR-Y/1023		1	055000905
C55STR-B/5015		1	055000904
C55STR-GO/1035		1	055000909
C55STR-S/9006		1	055000902



 Beta

TOOL ASSORTMENTS FOR STORAGE UNITS



ATTENTION!

Many of the assortments on the next few pages have undergone the following changes:



- introduction of new tools
- rationalisation of tools.

Therefore, we recommend you thoroughly examine assortments and take a look at the features of the reference item.

For industrial maintenance



Beta n.	N° of pieces			Arrangement	Assortment recommended in combination with	
5902VI	107	1	059020050	loose tools	C22S - C23S - C23ST - C25 - C27S	323
5904VI/1T	98	1	059040161	foam trays	C24S - C24SA - C33 - C39 with 5 - 6 - 7 - 8 drawers C23ST - C39T - C24SL - C24SL/CAB - C59 - C55	324
5904VI/2T	153	1	059040164	foam trays	C24S - C24SA - C33 - C39 with 7 - 8 drawers C24SL - C24SL/CAB - C59 - C55	325
5904VI/3T	142	1	059040168	foam trays	C24S - C24SA/A - C33 - C39 with 8 drawers C24SA-XL	326
5908VI/2T	232	1	059080105	foam trays	C28 - C24SA-XL	327
5910VI/3	297	1	059100053	loose tools	C30S	328
5910VI/3T	256	1	059100062	foam trays + loose tools	C30S	329
5935VI/1MB	94	1	059350311	soft modules	C35	330
5935VI/2MB	133	1	059350315	soft modules	C35	331
5953VI	137	1	059350075	loose tools	C53VI	332
5954VI	115	1	059540315	loose tools	C54VI	333
5957VI	162	1	059570050	loose tools with supports	C57S A - C57S B - C57SP - C55PSP	334

For universal maintenance



Beta n.	N° of pieces			Arrangement	Assortment recommended in combination with	
5904VU/1M	91	1	059040201	soft modules	C24S - C24SA - C33 - C39 with 5 - 6 - 7 - 8 drawers C23ST - C39T - C24SL - C24SL/CAB - C59 - C55	335
5904VU/2M	152	1	059040202	soft modules	C24S - C24SA - C33 - C39 with 6 - 7 - 8 drawers C24SL - C24SL/CAB - C59 - C55	336
5904VU/2T	104	1	059040520	foam trays	C24S - C24SA - C33 - C39 with 6 - 7 - 8 drawers C24SL - C24SL/CAB - C59 - C55	337
5904VU/3T	146	1	059040164	soft modules	C24S - C24SA - C33 - C39 with 6 - 7 - 8 drawers C24SL - C24SL/CAB - C59 - C55	338
5914VU/M	109	1	059140109	soft modules	C14	339
5915VU/0	35	1	059150121	loose tools	C4 - C5 - C6T	340
5915VU/1	45	1	059150124	loose tools	C9 - C10 - C10S - C11 - CP15 - CP15L - C16 - CP17 CP17L - C18	341
5915VU/2	49	1	059150127	loose tools	C7 - CP15 - C20 - C20L	342
5915VU/3	74	1	059150128	loose tools	C7 - C9 - C10 - C10S - C11 - CP15L - C16 - CP17 - CP17L - C19 - C19L - C20 - C20L	343
5915VU/4	80	1	059150145	loose tools	C20 - C20L	344
5915VU/5	111	1	059150156	loose tools	C12	345
5915VU/AS	68	1	059150132	loose tools	C10 - C20 - C20L	346
5927VU/M	108	1	059270021	soft modules	C22S - C27S	347
5935VU/1MB	154	1	059350301	soft modules	C35	348
5938U/2T	210	1	059380062	foam trays	C38	349
5957U-P	133	1	059570040	loose tools with supports	C57S A - C57S B - C57SP - C55PSP	350
5958U	85	1	059580028	loose tools with supports	C58P	351
5988U6/M	214	1	059880430	soft modules	C24S - C24SA/A - C33 - C39 with 8 drawers C24SA-XL	352

For electronic, electrotechnical and plumbing maintenance



electrotechnica

Beta n.	N° of pieces			Arrangement	Assortment recommended in combination with	
5935ET/1MB	95	1	059350331	soft modules	C35	353
5980ET/A	70	1	059800262	loose tools	C12 - 2032TV - 2032VV	354
5980ET/B	64	1	059800263	loose tools	C12 - 2029/VV - 2033P/VV - 2036TV	355

electronic



Beta n.	N° of pieces			Arrangement	Assortment recommended in combination with	
5980MQ	46	1	059800257	loose tools	2029/VV	356
5980EL/A	57	1	059800241	loose tools	2032TV - 2032VV - 2033P/VV	357
5980EL/B	98	1	059800242	loose tools	2029/VV - 2033P/VV - 2036TV	358

plumbing



Beta n.	N° of pieces			Arrangement	Assortment recommended in combination with	
5980ID	35	1	059800321	loose tools	2009N/VV	359

For car repair, earth moving machinery



earth moving

Beta n.	N° of pieces			Arrangement	Assortment recommended in combination with	
5902MT	106	1	059020043	loose tools	C22S - C23S - C23SC - C39T	360
5902MT/AS	99	1	059020044	loose tools	C22S - C23S - C23SC - C39T	361

car repair

Beta n.	N° of pieces			Arrangement	Assortment recommended in combination with	
5904VG/1M	76	1	059040197	soft modules	C24S - C24SA - C33 - C39 with 5 - 6 - 7 - 8 drawers C23ST - C39T - C24SL - C24SL/CAB - C59 - C55	362
5904VG/2M	170	1	059040198	soft modules	C24S - C24SA - C33 - C39 with 6 - 7 - 8 drawers C24SL - C24SL/CAB - C59 - C55	363
5904VG/2T	99	1	059040191	foam trays	C24S - C24SA - C33 - C39 with 5 - 6 - 7 - 8 drawers C23ST - C39T - C24SL - C24SL/CAB - C59 - C55	364
5904VG/3	132	1	059040192	loose tools	C24S - C24SA - C33 - C39 with 7 - 8 drawers C24SL - C24SL/CAB - C59 - C55	365
5904VG/3T	102	1	059040510	foam trays	C24S - C24SA - C33 - C39 with 6 - 7 - 8 drawers C24SL - C24SL/CAB - C59 - C55	366
5904VG/5T	153	1	059040196	foam trays	C24S - C24SA - C33 - C39 with 7 - 8 drawers C24SL - C24SL/CAB - C59 - C55	367
5905VG/1	94	1	059050158	loose tools	C25	368
5905VG/2	118	1	059050144	loose tools	C25	369
5908VG/2T	212	1	059080117	foam trays + loose tools	C28	370
5910VG/3T	202	1	059100067	foam trays + loose tools	C30S	371
5935VG/1MB	98	1	059350321	soft modules	C35	372
5953VG	147	1	059530085	loose tools	C53VG	374
5954VG	138	1	059540085	loose tools	C54VG	375
5957VG	174	1	059570060	loose tools with supports	C57S A - C57S B - C57SP - C55PSP	376

For motorcycle repairs

Beta n.	N° of pieces			Arrangement	Assortment recommended in combination with	
5940SBK	125	1	059400081	loose tools	C41S - C41H - C42S - C42H	373



5902VI

assortment of 107 tools

Industrial maintenance



19.5 kg

Quantity/Description

6	pin punches Ø 2 - 3 - 4 - 5 - 6 - 8 mm	31
1	centre punch Ø 3 mm	32
1	flat chisels, ribbed type 200 mm	35
26	combination wrenches 6÷32 mm	42/S26
12	double open end wrenches 6x7 - 8x9 - 10x11 - 12x13 - 14x15 - 16x17 - 18x19 - 20x22 - 21x23 - 24x26 - 25x28 - 30x32 mm	55/S12
9	offset hexagon key wrenches 1,5 - 2 - 2,5 - 3 - 4 - 5 - 6 - 8 - 10 mm	96N/SC9
1	adjustable wrench 300 mm	111
13	1/2" square drive hexagon sockets with rail 10÷22 mm	920A/SB13
1	1/2" drive extension bar 125 mm	920/21
1	1/2" drive extension bar 255 mm	920/22
1	1/2" drive universal joint	920/25
1	1/2" drive sliding T-handle	920/42
1	1/2" drive reversible ratchet	920/55
1	Slip joint pliers boxed joints 250 mm	1048
1	self - locking pliers 240 mm	1052
1	heavy duty diagonal cutting nippers 160 mm	1084BM
1	compound leverage shears, straight blades 250 mm	1122
1	electrician's scissors, straight blades	1128BMX

Quantity/Description

1	half-round needle nose pliers 180 mm	1150BM
1	extra long needle knurled nose pliers, bi-material handles 160 mm	1166BM
8	screwdrivers for cross head Phillips® screws 2,5x50 - 3x75 - 3,5x100 - 4x125 - 5,5x125 - 6,5x150 - 8x200 - 10x200 mm	1260
4	screwdrivers for cross head Phillips® screws PH0x60 - PH1x80 - PH2x100 - PH3x150 mm	1262
1	engineer's hammer 500 g	1370
1	dead blow hammer Ø 40 mm	1392
1	engineer's scriber	1688A
1	measuring tape 5 m	1692
1	metric feeler gauge	1708/20
5	Set of 5 second-cut files, with handles 200 mm	1719BMA/S5
1	hacksaw frame, aluminium handle	1726BM
1	metal oil can 300 cc	1751
1	snap - off blade utility knife	1771BM
1	magnetic, articulated lamp with high-brightness LEDs	1837N

5902VI

059020050

Assortment recommended in combination with C22S - C23S - C23ST - C25 - C27S

5904VI/1T

Assortment of 98 tools

Industrial maintenance



14.5 kg

Quantity/Description

19	1/2" square drive hexagon sockets \odot 10-24 - 26 - 27 - 30 - 32 mm	920A	T80
5	1/2" drive, socket drivers for hexagon screws \odot 5 - 6 - 8 - 10 - 12 mm	920ME	T80
1	1/2" drive extension bar 125 mm	920/21	T80
1	1/2" drive extension bar 255 mm	920/22	T80
1	1/2" drive universal joint	920/25	T80
1	1/2" drive sliding T-handle	920/42	T80
1	1/2" drive reversible ratchet \oplus	920/55	T80
21	combination wrenches 6+21 mm	42	T15
5	combination wrenches 22-24-27-30-32 mm	42	T16
1	Slip joint pliers boxed joints 250 mm	1048	T153
1	self - locking pliers 240 mm	1052	T153
1	heavy duty diagonal cutting nippers ∇ 160 mm	1084BM	T131
1	half-round needle nose pliers \equiv 180 mm	1150BM	T131
1	extra long needle knurled nose pliers, bi-material handles \bullet 160 mm	1166BM	T131
1	circlip pliers straight, internal \odot 180 mm	1032	T145
1	circlip pliers bent, internal \odot 170 mm	1034	T145

Beta N. TR

Quantity/Description

1	circlip pliers straight, external \bullet 175 mm	1036	T145
1	circlip pliers bent, external \bullet 175 mm	1038	T145
5	second cut files 200 mm	1719BMA8/S5	T236
2	flat chisels, ribbed type 100 - 200 mm	35	T234
1	engineer's hammer 300 g	1370	T234
1	soft face hammer \varnothing 35 mm	1390	T234
8	double open end wrenches 6x7 - 8x9 - 10x11 - 12x13 - 14x15 - 16x17 - 18x19 - 20x22 mm	55	T33
9	offset hexagon key wrenches \odot 1,5 - 2 - 2,5 - 3 - 4 - 5 - 6 - 8 - 10 mm	96/SC9	T33
4	screwdrivers for cross head Phillips® screws \bullet 3x75 - 4x100 - 5,5x150 - 6,5x150 mm	1260	T208
3	screwdrivers for cross head Phillips® screws \oplus PH0x60 - PH1x80 - PH2x100 mm	1262	T208
6	T-handle wrenches with hexagon male ends \odot 2,5 - 3 - 4 - 5 - 6 - 8 mm	951	T68

Beta N. TR

1036	T145
1038	T145
1719BMA8/S5	T236
35	T234
1370	T234
1390	T234
55	T33
96/SC9	T33
1260	T208
1262	T208
951	T68

5904 VI/1T

059040161

Assortment recommended in combination with C24S - C24SA - C33 - C39 with 5 - 6 - 7 - 8 drawers
C23ST - C39T - C24SL - C24SL/CAB - C59 - C55

5904VI/2T

assortment of 153 tools in thermoformed tray

Industrial maintenance



T15 T16 T31



T40 T83 T91



T167 T168



T153 T132 T145 T68



T236 T234 T281 T289

22 kg

Quantity/Description

16	combination wrenches 6÷21 mm	42	T15
5	combination wrenches 22 - 24 - 27 - 30 - 32 mm	42	T16
5	pin punches Ø 2 - 3 - 4 - 5 - 6 mm	31	T31
1	centre punch Ø 4 mm	32	T31
12	double open end wrenches 6x7 - 8x9 - 10x11 - 12x13 - 14x15 - 16x17 18x19 - 20x22 - 21x23 - 24x26 - 27x29 - 30x32 mm	55	T31
9	offset hexagon key wrenches Ø 1,5 - 2 - 2,5 - 3 - 4 - 5 - 6 - 8 - 10 mm	96N/SC9	T31
7	double ended offset ring wrenches 6÷29 mm	90	T40
19	1/2" square drive hexagon sockets Ø 10÷24 - 26 - 27 - 30 - 32 mm	920A	T83
1	1/2" drive extension bar 125 mm	920/21	T83
1	1/2" drive extension bar 255 mm	920/22	T83
1	1/2" drive universal joint	920/25	T83
1	1/2" drive sliding T-handle	920/42	T83
1	1/2" drive reversible ratchet	920/55	T83
13	1/4" hexagon sockets Ø 4÷14 mm	900	T91
6	1/4" socket drivers for hexagon screws Ø 2,5÷8 mm	900ME	T91
1	1/4" drive extension bar 50 mm	900/20	T91
1	1/4" drive extension bar 150 mm	900/21	T91
1	1/4" drive universal joint	900/25	T91
1	1/4" drive spinner handle	900BG/30	T91
1	1/4" drive swivel T-handle	900/42	T91
1	1/4" reversible ratchet	900/55	T91
9	screwdrivers for cross head Phillips® screws ● 3x75 - 3x100 - 4x100 - 4x150 - 5,5x100 - 5,5x150 6,5x150 - 8x150 - 10x200 mm	1260	T167
2	screwdrivers for slotted head screws, extra-short series ● 4x30 - 6,5x30 mm	1260N	T167
7	screwdrivers for cross head Phillips® screws ● PH0x60 - PH0x100 - PH1x80 - PH1x120 - PH2x100 - PH2x150 - PH3x150 mm	1262	T168

Quantity/Description

2	screwdrivers for cross head Phillips® screws, extra - short series ● PH1x30 - PH2x30 mm	1262N	T168
1	Slip joint pliers boxed joints 250 mm	1048	T153
1	self - locking pliers 240 mm	1052	T153
1	heavy duty diagonal cutting nippers 160 mm	1084	T132
1	screwdrivers for slotted head screws ● 160 mm	1166	T132
1	half-round needle nose pliers 180 mm	1150	T132
1	circlip pliers straight, internal Ø 180 mm	1032	T145
1	circlip pliers bent, internal Ø 170 mm	1034	T145
1	circlip pliers straight, external ● 175 mm	1036	T145
1	circlip pliers bent, external ● 175 mm	1038	T145
6	T-handle wrenches with hexagon male ends Ø 2,5 - 3 - 4 - 5 - 6 - 8 mm	951	T68
5	second cut files 200 mm	1719BMA8/S5	T236
2	flat chisels, ribbed type 100 - 200 mm	35	T234
1	engineer's hammer 300 g	1370	T234
1	soft face hammer Ø 35 mm	1390	T234
1	riveting pliers	1741B	T281
100	aluminium rivets 2,9x6 mm	1741RV...K	T281
100	aluminium rivets 3,2x8 mm	1741RV...K	T281
100	aluminium rivets 3,8x10 mm	1741RV...K	T281
100	aluminium rivets 4x12 mm	1741RV...K	T281
100	aluminium rivets 4,8x12 mm	1741RV...K	T281
1	measuring tape	1692	T289
1	mini hacksaw frame	1725CR	T289
1	plastic oil bottle	1755	T289
1	snap - off blade utility knife	1771	T289

5904VI/2T

059040164

Assortment recommended in combination with C24S - C24SA - C33 - C39 with 7 - 8 drawers
C24SL - C24SL/CAB - C59 - C55

5904VI/3T

assortment of 142 tools in thermoformed tray

Industrial maintenance

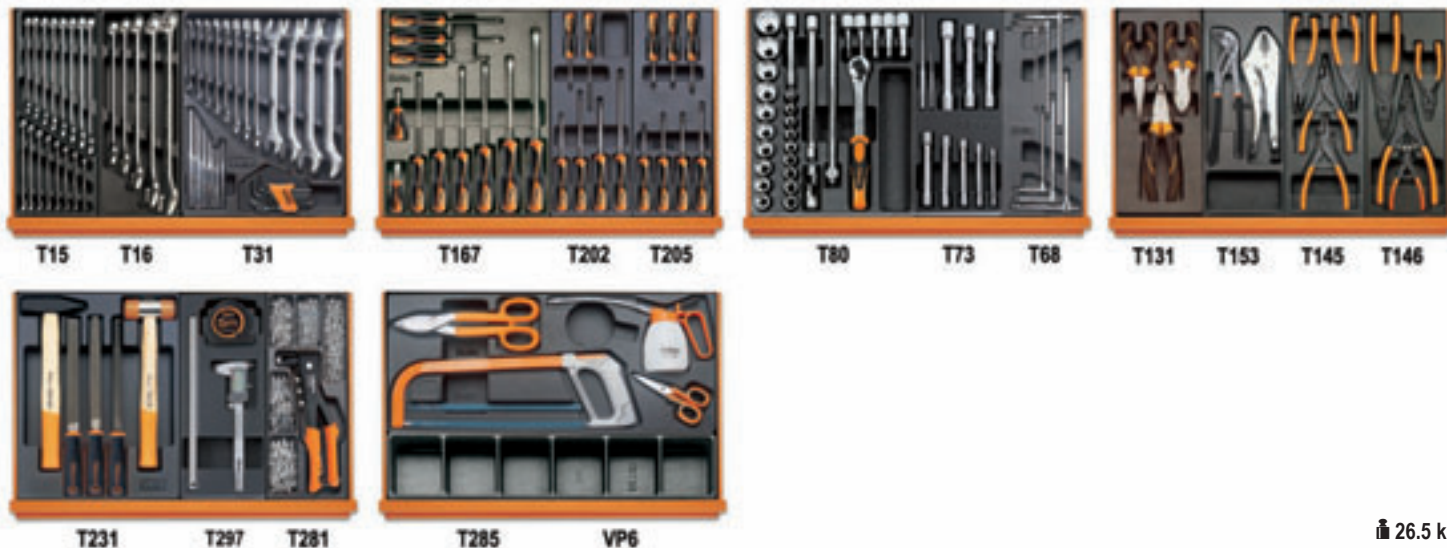

📦 26.5 kg

Quantity/Description

Quantity/Description	Beta N.	TR
16 combination wrenches 6÷21 mm	42	T15
5 combination wrenches 22 - 24 - 27 - 30 - 32 mm	42	T16
5 pin punches Ø 2 - 3 - 4 - 5 - 6 mm	31	T31
1 centre punch Ø 4 mm	32	T31
12 double open end wrenches 6x7 - 8x9 - 10x11 - 12x13 - 14x15 - 16x17 18x19 - 20x22 - 21x23 - 24x26 - 27x29 - 30x32 mm	55	T31
9 offset hexagon key wrenches Ø 1,5 - 2 - 2,5 - 3 - 4 - 5 - 6 - 8 - 10 mm	96N/SC9	T31
9 screwdrivers for cross head Phillips® screws ● 3x75 - 3,5x100 - 4x100 - 4x150 - 5,5x100 - 5,5x150 - 6,5x150 - 8x150 - 10x200 mm	1260	T167
2 screwdrivers for slotted head screws, extra-short series ● 4x30 - 6,5x30 mm	1260N	T167
6 screwdrivers for cross head Phillips® screws ● PH0x60 - PH0x100 - PH1x80 - PH1x120 - PH2x100 - PH2x150 mm	1262	T202
7 drivers for Torx® head screws ● T6-T7-T8-T9-T10-T15-T20	1267TX	T205
5 1/2" drive, socket drivers for hexagon screws ○ 5 - 6 - 8 - 10 - 12 mm	920ME	T80
1 1/2" drive extension bar 125 mm	920/21	T80
1 1/2" drive extension bar 255 mm	920/22	T80
1 1/2" drive universal joint	920/25	T80
1 1/2" drive sliding T-handle	920/42	T80
1 1/2" drive reversible ratchet Ⓢ	920/55	T80
19 1/2" square drive hexagon sockets ○ 10÷24 - 26 - 27 - 30 - 32 mm	920A	T80
8 double ended bi-hex tubular socket wrenches 6x7 - 8x9 - 10x11 - 12x13 - 14x15 - 16x17 18x19 - 20x22 mm	930	T73
1 tommy bars for tubular wrenches	940/1	T73
1 tommy bars for tubular wrenches	940/2	T73
6 T-handle wrenches with hexagon male ends ○ 2,5 - 3 - 4 - 5 - 6 - 8 mm	951	T68
1 half-round needle nose pliers = 180 mm	1150BM	T131
1 extra long needle knurled nose pliers, bi-material handles ● 160 mm	1166BM	T131
1 heavy duty diagonal cutting nippers ≧ 160 mm	1084BM	T131

Quantity/Description

Quantity/Description	Beta N.	TR
1 Slip joint pliers boxed joints 250 mm	1048	T153
1 self - locking pliers 240 mm	1052	T153
1 circlip pliers straight, internal ○ 180 mm	1032	T145
1 circlip pliers bent, internal ○ 170 mm	1034	T145
1 circlip pliers straight, external ● 175 mm	1036	T145
1 circlip pliers bent, external ● 175 mm	1038	T145
1 circlip pliers straight, internal ○ 140 mm	1032	T146
1 circlip pliers bent, internal ○ 225 mm	1034	T146
1 circlip pliers straight, external ● 140 mm	1036	T146
1 circlip pliers bent, external ● 225 mm	1038	T146
1 engineer's hammer 400 g	1370	T231
1 soft face hammer Ø 35 mm	1390	T231
1 second cut files 200 mm	1719BMA8/T	T231
1 second cut files 200 mm	1719BMA8/P	T231
1 second cut files 200 mm	1719BMA8/M	T231
1 digital vernier	1651DGT	T297
1 flexible graduated rule 300 mm	1682	T297
1 measuring tape 5 m	1691BM	T297
empty thermoformed tray	VP6	T297
1 riveting pliers 250 mm	1741B	T281
100 aluminium rivets 2,9x6 mm	1741RV...K	T281
100 aluminium rivets 3,2x8 mm	1741RV...K	T281
100 aluminium rivets 3,8x10 mm	1741RV...K	T281
100 aluminium rivets 4x12 mm	1741RV...K	T281
100 aluminium rivets 4,8x12 mm	1741RV...K	T281
1 tin snips 250 mm	1112	T285
1 electrician's scissors, straight blades	1128BM	T285
1 hacksaw frame, aluminium handle	1726	T285
(5) blades for hacksaw	1728BM	T285
1 plastic oil can 200 cc	1753	T285
empty thermoformed tray	VP6	VP6

5904VI/3T

059040168

Assortment recommended in combination with C24S - C24S/A - C33 - C39 with 8 drawers C24SA-XL

Industrial maintenance

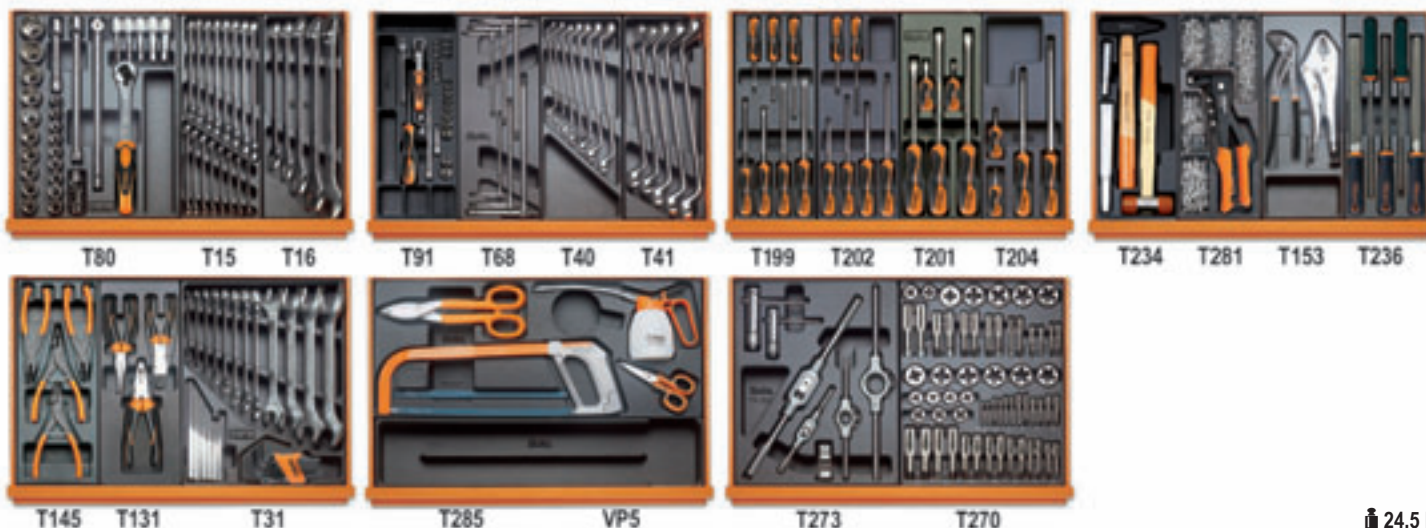

Quantity/Description	Beta N.	TR	Quantity/Description	Beta N.	TR
5 1/2" drive, socket drivers for hexagon screws \odot 5 - 6 - 8 - 10 - 12 mm	920ME	T80	100 aluminium rivets 4x12 mm	1741RV...K	T281
1 1/2" drive extension bar 125 mm	920/21	T80	100 aluminium rivets 4,8x12 mm	1741RV...K	T281
1 1/2" drive extension bar 255 mm	920/22	T80	1 Slip joint pliers boxed joints 250 mm	1048	T153
1 1/2" drive universal joint	920/25	T80	1 self - locking pliers 240 mm	1052	T153
1 1/2" drive sliding T-handle	920/42	T80	5 second cut files 200 mm	1719BMA8/S	T236
1 1/2" drive reversible ratchet $\text{\textcircled{R}}$	920/55	T80	1 circlip pliers straight, internal \odot 180 mm	1032	T145
19 1/2" square drive hexagon sockets	920A	T80	1 circlip pliers bent, internal \odot 170 mm	1034	T145
\odot 10÷24 - 26 - 27 - 30 - 32 mm			1 circlip pliers straight, external \bullet 175 mm	1036	T145
16 combination wrenches 6÷21 mm	42	T15	1 circlip pliers bent, external \bullet 175 mm	1038	T145
5 combination wrenches 22 - 24 - 27 - 30 - 32 mm	42	T16	1 half-round needle nose pliers \equiv 180 mm	1150BM	T131
13 1/4" hexagon sockets \odot 4÷14 mm	900	T91	1 extra long needle knurled nose pliers, bi-material handles \bullet 160 mm	1166BM	T131
6 1/4" socket drivers for hexagon screws	900ME	T91	1 heavy duty diagonal cutting nippers ζ 160 mm	1084BM	T131
\odot 2,5 - 3 - 4 - 5 - 6 - 8 mm			5 pin punches \emptyset 2 - 3 - 4 - 5 - 6 mm	31	T31
1 1/4" drive extension bar 50 mm	900/20	T91	1 centre punch \emptyset 4 mm	32	T31
1 1/4" drive extension bar 150 mm	900/21	T91	12 double open end wrenches	55	T31
1 1/4" drive spinner handle	900BG/30	T91	6x7 - 8x9 - 10x11 - 12x13 - 14x15 - 16x17		
1 1/4" drive universal joint	900/25	T91	18x19 - 20x22 - 21x23 - 24x26 - 27x29 - 30x32 mm		
1 1/4" drive swivel T-handle	900/42	T91	9 offset hexagon key wrenches	96N/SC9	T31
1 1/4" reversible ratchet $\text{\textcircled{R}}$	900/55	T91	\odot 1,5 - 2 - 2,5 - 3 - 4 - 5 - 6 - 8 - 10 mm		
6 T-handle wrenches with hexagon male ends	951	T68	1 tin snips 250 mm	1112	T285
\odot 2,5 - 3 - 4 - 5 - 6 - 8 mm			1 electrician's scissors, straight blades	1128BM	T285
7 double ended offset ring wrenches 6x7-8x9-10x11-12x13-14x15-16x17-18x19 mm	90	T40	1 hacksaw frame, aluminium handle	1726	T285
5 double ended offset ring wrenches 20x22 - 21x23 - 24x26 - 25x28 - 27x29 mm	90	T41	5 blades for hacksaw	1728BM	T285
7 screwdrivers for cross head Phillips® screws \bullet 2,5x50 - 3x75 - 3,5x100 - 4x125 - 5,5x100 - 5,5x150 - 6,5x150 mm	1260	T199	1 plastic oil can 200 cc	1753	T285
6 screwdrivers for cross head Phillips® screws \oplus PH0x60 - PH0x100 - PH1x80 - PH1x120 - PH2x100 - PH2x150 mm	1262	T202	1 empty thermoformed tray	VP5	VP5
3 screwdrivers for cross head Phillips® screws \bullet 8x200 - 10x150 - 10x200 mm	1260	T201	1 adjustable tap wrench M3÷M12	435/1,5	T273
2 screwdrivers for slotted head screws, extra-short series \bullet 4x30 - 6,5x30 mm	1260N	T201	1 adjustable tap wrench M5÷M21	435/3	T273
2 screwdrivers for cross head Phillips® screws	1262	T204	1 reversible ratcheting tap wrench 2,0÷5,0 mm (M3÷M8)	436/1	T273
\oplus PH3x150 - PH4x200 mm			1 reversible ratcheting tap wrench 4,6÷8,0 mm (M5÷M12)	436/2	T273
2 screwdrivers for cross head Phillips® screws, extra - short series \oplus PH1x30 - PH2x30 mm	1262N	T204	1 die stock 25,4 mm	444/1	T273
2 flat chisels, ribbed type 100 - 200 mm	35	T234	1 die stock 38,1 mm	444/2	T273
1 engineer's hammer 300 g	1370	T234	1 screw pitch gauge 0,25÷6 W 62÷4x1"	1707	T273
1 soft face hammer \emptyset 35 mm	1390	T234	26 coarse pitch hand taps M3 - 4 - 5 - 6 - 7 - 8 - 9 - 10 - 12 - 14 - 16 - 18 - 20	430	T270
1 riveting pliers 250 mm	1741B	T281	14 fine pitch hand taps M6x0,75 - M8x1 - M10x1,25	433	T270
100 aluminium rivets 2,9x6 mm	1741RV...K	T281	M12x1,5 - M14x1,5 - M16x1,5 - M18x1,5		
100 aluminium rivets 3,2x8 mm	1741RV...K	T281	7 round dies, coarse pitch M3 - 4 - 5 - 6 - 7 - 8 - 9	440	T270
100 aluminium rivets 3,8x10 mm	1741RV...K	T281	6 round dies, coarse pitch M10 - 12 - 14 - 16 - 18 - 20	440A	T270
			2 round dies, fine pitch M6x0,75 - M8x0,75	441	T270
			5 round dies, fine pitch M10x1,25 - M12x1,5 - M14x1,5 - M16x1,5 - M18x1,5	441A	T270

24,5 kg

Industrial maintenance



Quantity/Description

Beta N.

Quantity/Description

Beta N.

6	pin punches Ø 2 - 3 - 4 - 5 - 6 - 8 mm	31/B6	1	heavy duty diagonal cutting nippers \leq 160 mm	1084BM
1	centre punch Ø 4 mm	32	1	toggle lever assisted end cutting nippers \leq 180 mm	1092V
2	flat chisels, ribbed type 125 - 250 mm	35	1	tin snips 300 mm	1112
1	cape chisel, ribbed type 200 mm	37	1	tin snip, straight narrow blades 250 mm	1114
30	combination wrenches 6÷41 mm	42	1	electrician's scissors, straight blades	1128BMX
14	double open end wrenches 6x7 - 8x9 - 10x11 - 12x13 - 14x15 - 16x17	55	1	half-round needle nose pliers \equiv 180 mm	1150BM
	18x19 - 20x22 - 21x23 - 24x26 - 25x28 - 27x29 - 30x32 - 36x41 mm		1	extra long needle knurled nose pliers, bi-material handles \bullet 160 mm	1166BM
13	double ended offset ring wrenches 6x7÷30x32 mm	90	1	bent needle nose pliers \bullet 160 mm	1168BM
14	offset hexagon key wrenches	96N	9	screwdrivers for cross head Phillips® screws \bullet 2,5x50 - 3x75 -	1260
	Ø 1,5 - 2 - 2,5 - 3 - 4 - 5 - 6 - 8 - 10 - 12 - 13 - 14 - 17 - 19 mm		3,5x150 - 4x125 - 5,5x125 - 6,5x150 - 8x200 - 10x200 - 12x250 mm		
1	adjustable wrench 250 mm	111	2	screwdrivers for slotted head screws,	1260N
1	heavy duty pipe wrench 300 mm	362		extra-short series \bullet 4x30 - 6,5x30 mm	
25	twist drills with cylindrical shanks, short series 1÷13x0,5 mm	412/SP25	5	screwdrivers for cross head Phillips® screws \oplus PH0x100 - PH1x120 -	1262
37	assortment of HSS taps and dies, metric thread	447/C37		PH2x150 - PH3x150 - PH4x200 mm	
1	click type torque wrench 1/2", 40÷200 Nm	606/20	2	screwdrivers for cross head Phillips® screws, extra - short series \oplus	1262N
4	1/2" drive, socket drivers for hexagon screws Ø 10-12-14-17 mm	920ME		PH1x30 - PH2x30 mm	
25	20 sockets and 5 accessories	920A/C20X	7	drivers for Torx® head screws \oplus T6 - T8 - T10 - T15 - T20 - T25 - T30	1267TX
17	assortment of 12 sockets and 5 accessories 3/4"	928A/C12	2	engineer's hammer 300 - 600 g	1370
12	double ended hexagon/bi - hex offset socket wrenches 8 - 10 - 11 - 13	932	2	soft face hammer Ø 35 - 60 mm	1390
	- 14 - 17 - 19 - 22 - 24 - 27 - 30 - 32 mm		5	tapered extractors M3÷M18	1430/S5
14	T-handle wrenches with hexagon male ends 2÷14 mm	951/S14	1	two - leg universal puller 23÷70 mm	1500N/1
5	T handle wrenches with swivelling hexagon male ends	953	1	two - leg universal puller 23÷100 mm	1500N/2
	Ø 3 - 4 - 5 - 6 - 8 mm		1	sliding gauge	1650
3	circlip pliers straight, internal \odot 180 - 225 - 300 mm	1032	1	semirigid stainless steel rule 300 mm	1683
3	circlip pliers bent, internal \odot 170 - 210 - 290 mm	1034	1	engineer's scriber	1688A
3	circlip pliers straight, external \bullet 140x1,3 - 175 - 225 mm	1036	1	measuring tape 5 m	1692
3	circlip pliers bent, external \bullet 135x1,3 - 175 - 220 mm	1038	1	metric feeler gauge	1708/13
2	Slip joint pliers boxed joints 240 - 300 mm	1048	1	flexible magnetic pick-up tool 1,8 kg	1712E/2
1	self locking pliers, double adjustment	1051	5	200 mm	1719BMA/S5
			1	hacksaw frame, aluminium handle	1726BM
			1	riveting pliers	1741B
			1	metal oil can 200 cc	1751

5910VI/3T

assortment of 256 tools

Industrial maintenance



Quantity/Description

16	combination wrenches 6x21 mm
5	combination wrenches 22 - 24 - 27 - 30 - 32 mm
5	pin punches Ø 2 - 3 - 4 - 5 - 6 mm
1	centre punch Ø 4 mm
12	double open end wrenches 6x7 - 8x9 - 10x11 - 12x13 - 14x15 - 16x17 - 18x19 - 20x22 - 21x23 - 24x26 - 27x29 - 30x32 mm
9	offset hexagon key wrenches Ø 1,5 - 2 - 2,5 - 3 - 4 - 5 - 6 - 8 - 10 mm
5	double ended offset ring wrenches 20x22 - 21x23 - 24x26 - 25x28 - 27x29 mm
7	double ended offset ring wrenches 6x7 - 8x9 - 10x11 - 12x13 - 14x15 - 16x17 - 18x19 mm
5	1/2" drive, socket drivers for hexagon screws Ø 5 - 6 - 8 - 10 - 12 mm
1	1/2" drive extension bar 125 mm
1	1/2" drive extension bar 255 mm
1	1/2" drive universal joint
1	1/2" drive sliding T-handle
1	1/2" drive reversible ratchet
19	1/2" square drive hexagon sockets Ø 10+24 - 26 - 27 - 30 - 32 mm
9	screwdrivers for cross head Phillips® screws ● 3x75 - 3x100 - 4x100 - 4x150 - 5,5x100 - 5,5x150 - 6,5x150 - 8x150 - 10x200 mm
2	screwdrivers for slotted head screws, extra-short series ● 4x30 - 6,5x30 mm
7	screwdrivers for cross head Phillips® screws ● PH0x60 - PH0x100 - PH1x80 - PH1x120 - PH2x100 - PH2x150 - PH3x150 mm
2	screwdrivers for cross head Phillips® screws, extra - short series ● PH1x30 - PH2x30 mm
4	offset hexagon key wrenches Ø 13-14-17-19 mm
1	tin snips 250 mm
1	electrician's scissors, straight blades
1	hacksaw frame, aluminium handle
(5)	blades for hacksaw
1	plastic oil can 200 cc
1	half-round needle nose pliers 180 mm
1	extra long needle knurled nose pliers, bi-material handles ● 160 mm
1	heavy duty diagonal cutting nippers 160 mm
1	circclip pliers straight, internal Ø 180 mm
1	circclip pliers bent, internal Ø 170 mm

Beta N.

42
42
31
32
55
1
96N/SC9
90
90
1
920ME
25
920/21
37
920/22
1
920/25
17
920/42
14
920/55
5
920A
1
1260
1
1260N
1
1262
1
1262N
1
96N
1
1112
1128BM
5
1726
1
1728BM
1
1753
1
1150BM
1
1166BM
1
1084BM
1
1032
1
1034

Quantity/Description

1	circclip pliers straight, external ● 175mm
1	circclip pliers bent, external ● 175mm
2	flat chisels, ribbed type 100 - 200 mm
1	engineer's hammer 300 g
1	soft face hammer Ø 35 mm
1	second cut files 200 mm
4	combination wrenches 35-36-38-41 mm
90	double open end wrenches 36x41 mm
1	adjustable wrench 250 mm
1	heavy duty pipe wrench 300 mm
25	twist drills with cylindrical shanks, short series
37	assortment of HSS taps and dies, metric thread
1	click type torque wrench 200 Nm
17	assortment of 12 sockets and 5 accessories 3/4"
14	T-handle wrenches with hexagon male ends
5	T handle wrenches with swivelling hexagon male ends Ø 3-4-5-6-8 mm
1	circclip pliers straight, internal Ø 300 mm
1	circclip pliers bent, internal Ø 290 mm
1	circclip pliers straight, external ● 225 mm
1	circclip pliers bent, external ● 220 mm
1	Slip joint pliers boxed joints 300 mm
1	self locking pliers, double adjustment
1	toggle lever assisted end cutting nippers 180 mm
1	engineer's hammer 600 g
1	soft face hammer 60 mm
5	tapered extractors M3-M18
1	two - leg universal puller
1	sliding gauge
1	semirigid stainless steel rule
1	engineer's scriber
1	measuring tape 5 m
1	metric feeler gauge
1	flexible magnetic pick-up tool

Beta N.

1036
1038
35
1370
1390
1719BMA8/S5
42
55
111
362
412/SP25
447/C37
606/20
928A/C12
951/S14
953
1032
1034
1036
1038
1048
1051
1092V
1370
1390
1430/S5
1500/3
1650
1683
1688
1692
1708/13
1712E/2

5910 VI/3T

059100062

Assortment recommended in combination with C30S

industrial maintenance



MB11



MB47

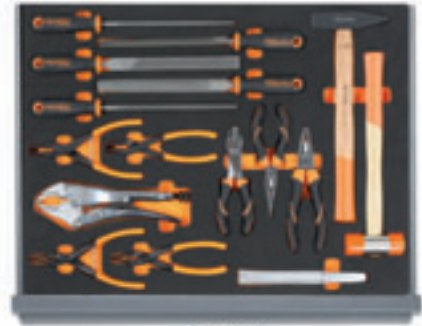

MB61

Quantity/Description

- 21 combination wrenches 6-7-8-9-10-11-12-13-14-15-16-17-18-19-20-21-22-24-27-30-32 mm
- 8 double open end wrenches 6x7-8x9-10x11-12x13-14x15-16x17-18x19-20x22 mm
- 1 Slip joint pliers boxed joints 250 mm
- 4 screwdrivers for cross head Phillips® screws
● 3x75-4x100-5x125-6,5x150 mm
- 3 screwdrivers for cross head Phillips® screws
⊕ PH0x60-PH1x80--PH2x100 mm
- 1 screwdrivers for slotted head screws,
extra-short series ● 4x30 mm
- 1 screwdrivers for cross head Phillips® screws,
extra - short series ⊕ PH1x30 mm
- 6 offset hexagon key wrenches ○ 2,5-3-4-5-6-8 mm
- 9 ball head offset hexagon key wrenches ○
- 19 1/2" square drive hexagon sockets ○ 10-11-12-13-14-15-16-17-18-19-20-21-22-23-24-26-27-30-32 mm
- 1 1/2" wobble extension bar 125 mm
- 1 1/2" wobble extension bar 250 mm
- 1 1/2" drive universal joint
- 1 1/2" drive sliding T-handle

Beta N.	TR
42	MB11
55	MB11
1048	MB11
1260	MB47
1262	MB47
1260N	MB47
1262N	MB47
96T	MB47
96BPC/SC9	MB47
920A	MB47
920AN/125	MB47
920AN/250	MB47
920/25	MB47
920/42	MB47

Quantity/Description

- 1 1/2" drive reversible ratchet ⊗
- 1 second-cut square files 200 mm
- 1 second-cut flat files 200 mm
- 1 second-cut triangular files 200 mm
- 1 second-cut half-round files 200 mm
- 1 second-cut round files 200 mm
- 1 flat chisels, ribbed type 200 mm
- 1 circlip pliers straight, internal ○ 180 mm
- 1 circlip pliers bent, internal ○ 170 mm
- 1 circlip pliers straight, external ● 175 mm
- 1 circlip pliers bent, external ● 175 mm
- 1 self - locking pliers 240 mm
- 1 heavy duty diagonal cutting nippers ⊥ 160 mm
- 1 half-round needle nose pliers = 180 mm
- 1 extra long needle knurled nose pliers,
bi-material handles ● 160 mm
- 1 engineer's hammer 500 g
- 1 soft face hammer Ø 35 mm

Beta N.	TR
920/55	MB47
1719BMA...Q	MB61
1719BMA...P	MB61
1719BMA...T	MB61
1719BMA...M	MB61
1719BMA...R	MB61
35	MB61
1032	MB61
1034	MB61
1036	MB61
1038	MB61
1052	MB61
1084BM	MB61
1150BM	MB61
1166BM	MB61
1370	MB61
1390	MB61

industrial maintenance



MB11



MB34



MB44



MB55

Quantity/Description

- 21 combination wrenches 6-7-8-9-10-11-12-13-14-15-16-17-18-19-20-21-22-24-27-30-32 mm
- 8 double open end wrenches 6x7-8x9-10x11-12x13-14x15-16x17-18x19-20x22 mm
- 1 Slip joint pliers boxed joints 250 mm
- 19 1/2" square drive hexagon sockets 10-11-12-13-14-15-16-17-18-19-20-21-22-23-24-26-27-30-32 mm
- 1 1/2" wobble extension bar 125 mm
- 1 1/2" wobble extension bar 150 mm
- 1 1/2" drive universal joint
- 1 1/2" drive sliding T-handle
- 1 1/2" drive reversible ratchet
- 1 adjustable wrench 250 mm
- 1 self-locking pliers 240 mm
- 1 heavy duty diagonal cutting nippers 160 mm
- 1 half-round needle nose pliers 180 mm
- 1 extra long needle knurled nose pliers, bi-material handles 160 mm
- 1 circlip pliers straight, internal 180 mm
- 1 circlip pliers bent, internal 170 mm
- 1 circlip pliers straight, external 175 mm
- 1 circlip pliers bent, external 175 mm
- 13 1/4" hexagon sockets 4-4.5-5-5.5-6-7-8-9-10-11-12-13-14 mm
- 1 1/4" drive extension bar 50 mm
- 1 1/4" drive extension bar 150 mm
- 1 1/4" drive universal joint
- 1 1/4" drive spinner handle

Beta N.	TR
42	MB11
55	MB11
1048	MB11
920A	MB34
920AN/125	MB34
920AN/250	MB34
920/25	MB34
920/42	MB34
920/55	MB34
111	MB34
1052	MB34
1084BM	MB34
1150BM	MB34
1166BM	MB34
1032	MB34
1034	MB34
1036	MB34
1038	MB34
900	MB34
900/20	MB34
900/21	MB34
900/25	MB34
900BG/30	MB34

Quantity/Description

- 1 1/4" reversible ratchet
- 1 1/4" drive swivel T-handle
- 7 screwdrivers for cross head Phillips screws 2,5x50-3x75-3,5x100-4x100-5,5x125-6,5x150-8x200 mm
- 2 screwdrivers for slotted head screws, extra-short series 4x30-6,5x30 mm
- 7 screwdrivers for cross head Phillips screws PH0x60-PH0x100-PH1x80-PH1x120-PH2x100-PH2x150-PH3x150 mm
- 2 screwdrivers for cross head Phillips screws, extra - short series PH1x30-PH2x30 mm
- 1 mains testing screwdriver 4x30-6,5x30 mm
- 9 ball head offset hexagon key wrenches
- 6 T-handle wrenches with hexagon male ends 2,5-3-4-5-6-8 mm
- 5 pin punches 2-3-4-5-6 mm
- 1 centre punch 4 mm
- 1 flat chisels, ribbed type 200 mm
- 1 tin snips 250 mm
- 1 electrician's scissors, straight blades
- 1 engineer's hammer 500 g
- 1 soft face hammer 45 mm
- 1 second-cut square files 200 mm
- 1 second-cut triangular files 200 mm
- 1 second-cut flat files 200 mm
- 1 second-cut half-round files 200 mm
- 1 second-cut round files 200 mm
- 1 hacksaw frame, aluminium handle 440 mm

Beta N.	TR
900/55	MB34
900/42	MB34
1260	MB44
1260N	MB44
1262	MB44
1262N	MB44
1253	MB44
96BPC/SC9	MB44
951	MB44
31	MB55
32	MB55
35	MB55
1112	MB55
1128BMX	MB55
1370	MB55
1390	MB55
1719BMA...Q	MB55
1719BMA...T	MB55
1719BMA...P	MB55
1719BMA...M	MB55
1719BMA...R	MB55
1726	MB55

Industrial maintenance



22.5 kg

Quantity/Description

- 5 pin punches Ø 2 - 3 - 4 - 5 - 6 mm
- 1 centre punch Ø 4 mm
- 2 flat chisels, ribbed type 200 - 250 mm
- 18 combination wrenches
6÷14 - 16 - 17 - 18 - 19 - 21 - 22 - 24 - 27 - 30 mm
- 12 double open end wrenches 6x7 - 8x9 - 10x11 - 12x13 - 14x15 - 16x17
18x19 - 20x22 - 21x23 - 24x26 - 27x29 - 30x32 mm
- 12 offset hexagon key wrenches ○ 2÷10 mm
- 1 adjustable wrench 250 mm
- 1 pipe wrench Swedish pattern 320 mm
- 20 1/2" square drive bi - hex sockets ○ 10÷24 - 26 - 27 - 28 - 30 - 32 mm
- 6 1/2" drive, socket drivers for hexagon screws
○ 5 - 6 - 8 - 10 - 12 - 14 mm
- 1 1/2" drive extension bar 125 mm
- 1 1/2" drive extension bar 255 mm
- 1 1/2" drive universal joint
- 1 1/2" drive swivel T-handle
- 1 1/2" drive sliding T-handle
- 1 1/2" drive reversible ratchet
- 6 T-handle wrenches with hexagon male ends ○ 2,5 - 3 - 4 - 5 - 6 - 8 mm
- 2 circlip pliers straight, internal ○ 140 - 180 mm
- 1 circlip pliers bent, internal ○ 170 mm
- 2 circlip pliers straight, external ● 140x1,3 - 175 mm
- 1 circlip pliers bent, external ● 175 mm

Beta N.

- 31
- 32
- 35
- 42
- 55
- 96/SC12
- 111
- 374
- 920B
- 920ME
- 920/21
- 920/22
- 920/25
- 920/40
- 920/42
- 920/55
- 951
- 1032
- 1034
- 1036
- 1038

Quantity/Description

- 1 Slip joint pliers boxed joints 240 mm 1048
- 1 self - locking pliers 240 mm 1052
- 1 heavy duty diagonal cutting nippers < 160 mm 1084BM
- 1 toggle lever assisted end cutting nippers < 180 mm 1092V
- 1 tin snips 250 mm 1112
- 1 electrician's scissors, straight blades 1128BMX
- 1 half-round needle nose pliers = 180 mm 1150BM
- 1 extra long needle knurled nose pliers, bi-material handles ● 160 mm 1166BM
- 1 mains testing screwdriver ● 1253
- 9 screwdrivers for cross head Phillips® screws ● 3x75 - 3,5X100 - 4x100 - 5,5x100 - 5,5x150 - 6,5X150 - 8X150 -10X200 - 12x250 mm 1260
- 2 screwdrivers for slotted head screws, extra-short series ● 4x30 - 6,5x30 mm 1260N
- 8 screwdrivers for cross head Phillips® screws ● PH0x60 - PH0x100 - PH1x80 - PH1x120 - PH2x100 - PH2x150 - PH3x150 -PH4X200 mm 1262
- 2 screwdrivers for cross head Phillips® screws, extra - short series ● PH1x30 - PH2x30 mm 1262N
- 2 engineer's hammer 300 - 500 g 1370
- 1 soft face hammer Ø 45 mm 1390
- 1 flexible magnetic pick-up tool 0,5 kg 1712E/1
- 5 second cut files 200 mm 1719BMA8/S5
- 1 hacksaw frame, aluminium handle 1726BM
- 1 plastic oil can 250 cc 1754

5953 VI

059530075

Assortment recommended in combination with C53VI

Industrial maintenance



17 kg

Quantity/Description

2	drift punches Ø 2 - 3 mm
5	pin punches Ø 2 - 3 - 4 - 5 - 6 mm
1	centre punch Ø 4 mm
1	flat chisels 150 mm
1	cape chisels, standard type 150 mm
18	combination wrenches 6÷22 - 24 mm
12	double open end wrenches 6x7 - 8x9 - 10x11 - 12x13 - 14x15 - 16x17 - 18x19 - 20x22 - 21x23 - 24x27 - 25x28 - 30x32 mm
12	offset hexagon key wrenches \odot 2÷10 mm
1	adjustable wrench 250 mm
20	1/2" square drive hexagon sockets \odot 10÷24 - 26 - 27 - 28 - 30 - 32 mm
1	1/2" drive extension bar 125 mm
1	1/2" drive extension bar 255 mm
1	1/2" drive universal joint
1	1/2" drive sliding T-handle
1	1/2" drive reversible ratchet \otimes
1	circlip pliers straight, internal \odot 180 mm
1	circlip pliers bent, internal \odot 170 mm
1	circlip pliers straight, external \bullet 175 mm
1	circlip pliers bent, external \bullet 175 mm
1	Slip joint pliers boxed joints 250 mm
1	self - locking pliers 240 mm
1	diagonal cutting nippers ∇ 160 mm
1	tin snips 250 mm

Beta N.

30
31
32
34
36
42
55/S12X
96/SC12
111
920A
920/21
920/22
920/25
920/42
920/55
1032
1034
1036
1038
1048
1052
1082BM
1112

Quantity/Description

1	electrician's scissors, straight blades
1	half-round needle nose pliers \equiv 180 mm
1	extra long needle knurled nose pliers, bi-material handles \bullet 160 mm
1	bent needle nose pliers \bullet 200 mm
5	screwdrivers for cross head Phillips® screws \bullet 3x75 - 4x125 - 5,5x125 - 6,5x150 - 10x200 mm
1	screwdrivers for slotted head screws, extra-short series \bullet 4x30 mm
3	screwdrivers for cross head Phillips® screws \oplus PH0x60 - PH1x80 - PH2x100 mm
1	screwdrivers for cross head Phillips® screws, extra - short series \oplus PH1x30 mm
1	engineer's hammer 400 g
1	dead blow hammer Ø 35 mm
1	puller with floating legs
1	crimping pliers for insulated terminals
1	measuring tape 5 m
1	metric feeler gauge
1	flexible magnetic pick-up tool 1,8 kg
5	second cut files 200 mm
1	hacksaw frame, aluminium handle
1	riveting pliers
1	plastic oil can 250 cc

Beta N.

1128BMX
1150BM
1166BM
1168BM
1260
1260N
1262
1262N
1370
1392
1515/3
1602
1692
1708/20
1712E/2
1719BMA/S5
1726BM
1741B
1754

5954 VI

059540075

Assortment recommended in combination with C54VI

Industrial maintenance



32 kg

Quantity/Description

6	pin punches Ø 2 - 3 - 4 - 5 - 6 - 8 mm	31/SP6
6	2 drift punches, 1 centre punch, 3 flat chisels with metal holder	38/SP6
19	combination wrenches 6+22 - 24 - 27 mm	42
12	double ended offset ring wrenches 6x7+30x32 mm	90/S12X
12	offset hexagon key wrenches Ø 2+10 mm	96/SC12
1	adjustable wrench 250 mm	111
13	1/2" square drive bi-hex sockets with rail Ø 10+22 mm	920B/SB13
8	1/2" square drive bi-hex sockets with rail Ø 23+32 mm	920B/SB8
4	1/2" socket drivers for slotted head screws ● 1,2x6,5 - 1,2x8 - 1,6x9 - 2x12 mm	920LP
3	1/2" socket drivers for Phillips® screws ⊕ PH2 - 3 - 4	920PH
1	1/2" drive extension bar 125 mm	920/21
1	1/2" drive extension bar 255 mm	920/22
1	1/2" drive universal joint	920/25
1	1/2" drive swivel handle	920/35A
1	1/2" drive sliding T-handle	920/42
1	1/2" drive reversible ratchet ⊗	920/55
1	pry bar	963
1	bent point tweezers 130 mm	991
1	straight large point tweezers 150 mm	994
1	circlip pliers straight, internal Ø 180 mm	1032
1	circlip pliers bent, internal Ø 170 mm	1034
1	circlip pliers straight, external ● 175 mm	1036
1	circlip pliers bent, external ● 175 mm	1038
1	Slip joint pliers boxed joints 250 mm	1048
1	self locking pliers, double adjustment	1051
1	heavy duty diagonal cutting nippers ⚡ 160 mm	1084BM
1	toggle lever assisted end cutting nippers ⚡ 180 mm	1092V
1	tin snips 250 mm	1112
1	tin snip, straight narrow blades 250 mm	1114
1	electrician's scissors, straight blades	1128BMX
1	half-round needle nose pliers ≡ 180 mm	1150BM
1	extra long needle knurled nose pliers, bi-material handles ● 160 mm	1166BM

Quantity/Description

1	bent needle nose pliers ● 200 mm	1168BM
7	screwdrivers for cross head Phillips® screws ● 3x75 - 3,5x100 - 4x125	1260
1	screwdrivers for slotted head screws with hexagon bolsters ● 12x250 mm	1260E
3	screwdrivers for cross head Phillips® screws ⊕ PH0x60 - PH1x80 - PH2x100 mm	1262
2	engineer's hammer 300 - 600 g	1370
1	soft face hammer Ø 35 mm	1390
1	measuring tape 5 m	1692
1	flexible magnetic pick-up tool 1,8 kg	1712E/2
1	two cutting edges scraper 200 mm	1717A
1	three - cutting edges scraper 200 mm	1717B
5	second cut files 200 mm	1719BMA/S5
1	hacksaw frame, aluminium handle	1725
1	metal oil can 200 cc	1751
2	flat chisels, ribbed type 200 - 250 mm	35
1	cape chisel, ribbed type 200 mm	37
6	offset hexagon key wrenches, with high torque handles Ø 2+6 mm	96T/S6
10	double ended hexagon/bi - hex offset socket wrenches 8 - 10 - 11 - 13 - 14 - 17 - 19 - 22 - 24 - 27 mm	932
1	circlip pliers straight, internal Ø 140 mm	1032
1	circlip pliers bent, internal Ø 130 mm	1034
1	circlip pliers straight, external ● 140x1,3 mm	1036
1	circlip pliers bent, external ● 135x1,3 mm	1038
1	self - locking pliers 280 mm	1060
1	self - locking pliers 290 mm	1062
1	engineer's hammer 1000 g	1370
1	dead blow hammer Ø 50 mm	1392
1	two - leg universal puller 25+130 mm	1500N/2
1	sliding gauge	1650
1	semirigid stainless steel rule 300 mm	1683
1	engineer's scriber	1688A
1	metric feeler gauge	1708/13
1	fold - away knife	1777BM

059570050

059570050

Assortment recommended in combination with C57S A - C57S B - C57SP - C55PSP

5904VU/1M

assortment of 91 tools

Universal maintenance



Quantity/Description	Beta N.	TR	Quantity/Description	Beta N.	TR
16 combination wrenches 6÷21 mm	42	M15	1 heavy duty diagonal cutting nippers 160 mm	1084	M132
8 double open end wrenches 6x7 - 8x9 - 10x11 - 12x13 - 14x15 - 16x17 18x19 - 20x22 mm	55	M33	1 half-round needle nose pliers 180 mm	1150	M132
9 offset hexagon key wrenches Ø 1,5 - 2 - 2,5 - 3 - 4 - 5 - 6 - 8 - 10 mm	96/SC9	M33	1 screwdrivers for slotted head screws 160 mm	1166	M132
7 screwdrivers for cross head Phillips® screws 2,5x50 - 3x75 - 3,5x100 - 4x125 - 5,5x100 - 5,5x150 - 6,5x150 mm	1260	M199	1 Slip joint pliers boxed joints 250 mm	1048	M153
6 screwdrivers for cross head Phillips® screws PH0x60 - PH0x100 - PH1x80 - PH1x120 - PH2x100 - PH2x150 mm	1262	M202	1 self - locking pliers 240 mm	1052	M153
8 offset hexagon key wrenches Ø 2-2,5-3-4-5-6-7-8 mm	96T	M50	2 flat chisels, ribbed type 100 - 200 mm	35	M234
1 1/2" wobble extension bar 125 mm	920AN/125	M83	1 engineer's hammer 300 g	1370	M234
1 1/2" wobble extension bar 250 mm	920AN/250	M83	1 soft face hammer Ø 35 mm	1390	M234
1 1/2" drive universal joint	920/25	M83	1 circlip pliers straight, internal Ø 180 mm	1032	M145
1 1/2" drive sliding T-handle	920/42	M83	1 circlip pliers bent, internal Ø 170 mm	1034	M145
1 1/2" drive reversible ratchet	920/55	M83	1 circlip pliers straight, external Ø 175 mm	1036	M145
19 1/2" square drive hexagon sockets Ø 10÷24 - 26 - 27 - 30 - 32 mm	920A	M83	1 circlip pliers bent, external Ø 175 mm	1038	M145

5904 VU/1M

059040201

Assortment recommended in combination with C24S - C24SA - C33 - C39 with 5 - 6 - 7 - 8 drawers
C23ST - C39T - C24SL - C24SL/CAB - C59 - C55

Universal maintenance



M15 M33 M199 M202



M50 M83



M132 M153 M237 M145



M204 M289 M85 M236

Quantity/Description

16	combination wrenches 6÷21 mm
8	double open end wrenches 6x7 - 8x9 - 10x11 - 12x13 - 14x15 - 16x17 - 18x19 - 20x22 mm
9	offset hexagon key wrenches Ø 1,5 - 2 - 2,5 - 3 - 4 - 5 - 6 - 8 - 10 mm
7	screwdrivers for cross head Phillips® screws ● 2,5x50 - 3x75 - 3,5x100 - 4x125 - 5,5x100 - 5,5x150 - 6,5x150 mm
6	screwdrivers for cross head Phillips® screws ⊕ PH0x60 - PH0x100 - PH1x80 - PH1x120 - PH2x100 - PH2x150 mm
8	offset hexagon key wrenches Ø 2-2,5-3-4-5-6-7-8 mm
1	1/2" wobble extension bar 125 mm
1	1/2" wobble extension bar 250 mm
1	1/2" drive universal joint
1	1/2" drive sliding T-handle
1	1/2" drive reversible ratchet ⊗
19	1/2" square drive hexagon sockets Ø 10÷24 - 26 - 27 - 30 - 32 mm
1	heavy duty diagonal cutting nippers ⚡ 160 mm
1	half-round needle nose pliers = 180 mm
1	screwdrivers for slotted head screws ● 160 mm
1	Slip joint pliers boxed joints 250 mm
1	self - locking pliers 240 mm
2	flat chisels, ribbed type 100 - 200 mm
1	mechanic's hammers 300 g
1	nylon face hammers, wooden shafts Ø 35 mm

Beta N.	TR
42	M15
55	M33
96/SC9	M33
1260	M199
1262	M202
96T	M50
920AN/125	M83
920AN/250	M83
920/25	M83
920/42	M83
920/55	M83
920A	M83
1084	M132
1150	M132
1166	M132
1048	M153
1052	M153
35	M237
1370T	M237
1390N	M237

Quantity/Description

1	circlip pliers straight, internal ○ 180 mm	1032	M145
1	circlip pliers bent, internal ○ 170 mm	1034	M145
1	circlip pliers straight, external ● 175 mm	1036	M145
1	circlip pliers bent, external ● 175 mm	1038	M145
6	drivers for Torx® head screws ⊙ T8-T10-T15-T20-T25-T30	1267TX	M204
1	measuring tape 5 m	1692	M289
1	mini hacksaw frame	1725CR	M289
1	plastic oil bottle 30 cc	1755	M289
1	snap - off blade utility knife	1771	M289
5	bits for slotted head screws, coloured ● 0,5x3 - 0,6x4,5 - 0,8x5,5 - 1x5,5 - 1,2x6,5 mm	860LP	M85
8	hexagon bits for power drivers, coloured Ø 2 - 2,5 - 3 - 4 - 5 - 6 - 8 - 10 mm	860PE	M85
5	bits for cross head Phillips® screws, coloured ⊕ PH0 - PH1 - PH2 - PH3 - PH4	860PH	M85
4	bits for cross head Pozidriv® - Supadriv® screws, coloured ⊕ PZ1 - PZ2 - PZ3 - PZ4	860PZ	M85
10	bits for Torx® head screws, coloured ⊙ T6-T7-T8-T9-T10-T15-T20-T25-T27-T30-T40	860TX	M85
8	bits for Tamper Resistant Torx® head screws, coloured ⊕ T9-T10-T15-T20-T25-T27-T30-T40	860RTX	M85
1	magnetic bit holder with handle 230 mm	851SR	M85
1	reversible bit ratchet 100 mm	860/55	M85
1	adaptors for drivers	892/0	M85
1	magnetic bit holder extension bar	882P	M85

5904VU/2T

assortment of 104 tools in foam trays

Universal use



T199 T202 T83



T145 T153 T131 T234



T68 T33 T15 T16



T287

Quantity/Description

- 7 screwdrivers for cross head Phillips® screws ● 2,5x50 - 3x75 - 3,5x100 - 4x125-5,5x100 - 5,5x150 - 6,5x150 mm
- 6 screwdrivers for cross head Phillips® screws ⊕ PH0x60 - PH0x100 - PH1x80 - PH1x120 - PH2x100 - PH2x150 mm
- 19 1/2" square drive hexagon sockets
○ 10-11-12-13-14-15-16-17-18-19
20-21-22-23-24-26-27-30-32 mm
- 1 1/2" drive extension bar 125 mm
- 1 1/2" drive extension bar 255 mm
- 1 1/2" drive universal joint
- 1 1/2" drive sliding T-handle 305 mm
- 1 1/2" drive reversible ratchet ⊗
- 1 circlip pliers straight, internal ○ 180 mm
- 1 circlip pliers bent, internal ○ 170 mm
- 1 circlip pliers straight, external ● 175 mm
- 1 circlip pliers bent, external ● 175 mm
- 1 Slip joint pliers boxed joints 250 mm
- 1 self - locking pliers 240 mm
- 1 heavy duty diagonal cutting nippers † 160 mm
- 1 half-round needle nose pliers = 180 mm

Beta N.

TR

- 1260 T199
- 1262 T202
- 920A T83
- 920/21 T83
- 920/22 T83
- 920/25 T83
- 920/42 T83
- 920/55 T83
- 1032 T145
- 1034 T145
- 1036 T145
- 1038 T145
- 1048 T153
- 1052 T153
- 1084BM T131
- 1150BM T131

Quantity/Description

- 1 extra long needle knurled nose pliers, bi-material handles ● 160 mm
- 2 flat chisels, ribbed type 100-200 mm
- 1 engineer's hammer 300 g
- 1 soft face hammer Ø 35 mm
- 6 T-handle wrenches with hexagon male ends
○ 2,5-3-4-5-6-8 mm
- 8 double open end wrenches 6x7-8x9-10x11-12x13-14x15
16x17-18x19-20x22 mm
- 9 offset hexagon key wrenches ○ 1,5+10 mm
- 16 combination wrenches 6-7-8-9-10-11-12-13-14-15-16-17
18-19-20-21 mm
- 5 combination wrenches 22-24-27-30-32 mm
- 1 electrician's scissors, straight blades
- 1 Multiuse scissors
- 1 second-cut square files 200 mm
- 1 second-cut flat files 200 mm
- 1 second-cut triangular files 200 mm
- 1 second-cut half-round files 200 mm
- 1 second-cut round files 200 mm
- 1 hacksaw frame, aluminium handle
- 1 blades for hacksaw
- 1 snap - off blade utility knife 170 mm
- 1 foldaway knife 185 mm

Beta N.

TR

- 1166BM T131
- 35 T234
- 1370 T234
- 1390 T234
- 951 T68
- 55 T33
- 96/SC9 T33
- 42 T15
- 42 T16
- 1128BMX T287
- 1130BMX T287
- 1719BMA...Q T287
- 1719BMA...P T287
- 1719BMA...T T287
- 1719BMA...M T287
- 1719BMA...R T287
- 1726BM T287
- 1728BM T287
- 1771BM T287
- 1778 T287

5904VU/2T

059040520

Assortment recommended in combination with C24S - C24SA - C33 - C39 with 6 - 7 - 8 drawers
C24SL - C24SL/CAB - C59 - C55

Universal maintenance



T15 T16 T31



T52 T55 T80



T91 T145 T132 T153



T198 T205 T234 T236

Quantity/Description

16	combination wrenches 6÷21 mm	42	T15
5	combination wrenches 22 - 24 - 27 - 30 - 32 mm	42	T16
5	pin punches Ø 2 - 3 - 4 - 5 - 6 mm	31	T31
1	centre punch Ø 4 mm	32	T31
12	double open end wrenches 6x7 - 8x9 - 10x11 - 12x13 - 14x15 - 16x17 18x19 - 20x22 - 21x23 - 24x26 - 27x29 - 30x32 mm	55	T31
9	offset hexagon key wrenches Ø 1,5 - 2 - 2,5 - 3 - 4 - 5 - 6 - 8 - 10 mm	96N/SC9	T31
6	offset hexagon key wrenches Ø 2 - 2,5 - 3 - 4 - 5 - 6 mm	96T	T52
6	drivers for Torx® head screws, with handles ⊕ T10-T15-T20-T25-T27-T30	97TTX	T55
5	1/2" drive, socket drivers for hexagon screws Ø 5 - 6 - 8 - 10 - 12 mm	920ME	T80
1	1/2" drive extension bar 125 mm	920/21	T80
1	1/2" drive extension bar 255 mm	920/22	T80
1	1/2" drive universal joint	920/25	T80
1	1/2" drive sliding T-handle	920/42	T80
1	1/2" drive reversible ratchet ⊕	920/55	T80
19	1/2" square drive hexagon sockets Ø 10÷24 - 26 - 27 - 30 - 32 mm	920A	T80
13	1/4" hexagon sockets Ø 4-4,5-5-5,5-6-7-8-9-10-11-12-13-14 mm	900	T91
6	1/4" socket drivers for hexagon screws Ø 2,5-3-4-5-6-8 mm	900ME	T91
1	1/4" drive extension bar 50 mm	900/20	T91
1	1/4" drive extension bar 150 mm	900/21	T91
1	1/4" drive universal joint	900/25	T91
1	1/4" drive spinner handle	900BG/30	T91
1	1/4" drive swivel T-handle 115 mm	900/42	T91

Beta N. TR

Quantity/Description

1	1/4" reversible ratchet ⊕	900/55	T91
1	circlip pliers straight, internal Ø 180 mm	1032	T145
1	circlip pliers bent, internal Ø 170 mm	1034	T145
1	circlip pliers straight, external Ø 175 mm	1036	T145
1	circlip pliers bent, external Ø 175 mm	1038	T145
1	half-round needle nose pliers = 180 mm	1150	T132
1	screwdrivers for slotted head screws ● 160 mm	1166	T132
1	heavy duty diagonal cutting nippers ≡ 160 mm	1084	T132
1	Slip joint pliers boxed joints 250 mm	1048	T153
1	self - locking pliers 240 mm	1052	T153
4	screwdrivers for cross head Phillips® screws ● 3x75 - 4x100 - 5,5x150 - 6,5x150 mm	1260	T198
3	screwdrivers for cross head Pozidriv®-Supadriv® screws ⊕ PZ0 - PZ1 - PZ2	1269PZ	T198
7	drivers for Torx® head screws ⊕ T6-T7-T8-T9-T10-T15-T20	1267TX	T205
2	flat chisels, ribbed type 100 - 200 mm	35	T234
1	engineer's hammer 300 g	1370	T234
1	soft face hammer Ø 35 mm	1390	T234
5	second cut files 200 mm	1719BMA8/S5	T236

Beta N. TR

5914VU/M

assortment of 109 tools for tool trolley C14, in soft foam tray

Universal use



MC T1



MC T2



MC T3

Quantity/Description

31	bits with magnetic quick release bit holder in plastic case ● ○ ⊕ ⊕ ⊕	860MIX/A31	MCT1
1	socket holder	895/3	MCT1
13	1/4" hexagon sockets ○ 4-4.5-5-5.5-6-7-8-9-10-11-12-13-14 mm	900	MCT1
1	1/4" drive universal joint	900/25	MCT1
1	1/4" drive spinner handle	900BG/30C	MCT1
1	1/4" drive swivel T-handle	900/42	MCT1
1	1/4" reversible ratchet ⊕	900/55	MCT1
16	1/2" square drive hexagon sockets ○ 10-11-12-13-14-15-16-17-18-19-21-22-24-27-30-32 mm	920A	MCT1
1	1/2" drive universal joint	920/25	MCT1
1	1/2" wobble extension bar	920AN/125	MCT1
1	1/2" drive sliding T-handle	920/42	MCT1
1	1/2" drive reversible ratchet ⊕	920/55	MCT1
14	combination wrenches 6-7-8-10-11-12-13-14-16-17-18-19-21-22 mm	42	MCT2

Beta N.

TR

Quantity/Description

9	offset hexagon key wrenches ○	96/SC9	MCT2
1	adjustable wrench 250 mm	111	MCT2
1	electrician's scissors, straight blades	1128BMX	MCT2
1	measuring tape 5 mt	1692/5	MCT2
1	snap - off blade utility knife	1771	MCT2
1	Slip joint pliers boxed joints 250 mm	1048	MCT3
1	diagonal cutting nippers £ 160 mm	1082BM	MCT3
1	half-round needle nose pliers = 180 mm	1150BM	MCT3
1	extra long needle knurled nose pliers, bi-material handles ● 160 mm	1166BM	MCT3
3	screwdrivers for cross head Phillips® screws ● 3,5x100-5,5x125-6,5x150 mm	1260	MCT3
3	screwdrivers for cross head Phillips® screws ⊕ PHx60-PH1x80-PH3x100 mm	1262	MCT3

Beta N.

TR

96/SC9	MCT2
111	MCT2
1128BMX	MCT2
1692/5	MCT2
1771	MCT2
1048	MCT3
1082BM	MCT3
1150BM	MCT3
1166BM	MCT3
1260	MCT3
1262	MCT3

Universal use



Quantity/Description

1	centre punch 4 mm	32
1	flat chisels, ribbed type 125 mm	35
8	double open end wrenches 6x7-8x9-10x11-12x13-14x15-16x17-18x19-20x22 mm	55
7	Offset hexagon key wrenches 1,5-2-2,5-3-4-5-6 mm	96/BGS7
1	adjustable wrench 150 mm	111
1	Slip joint pliers boxed joints 250 mm	1048
1	diagonal cutting nippers 160 mm	1082
1	electrician's scissors, straight blades	1128BMX
1	half-round needle nose pliers 180 mm	1150

Beta N.

Quantity/Description

1	screwdrivers for slotted head screws 160 mm	1166
4	screwdrivers for cross head Phillips® screws 3x75-4x100-5,5x100-6,5x150 mm	1201
3	screwdrivers for cross head Phillips® screws PH0x60-PH1x80-PH2x100 mm	1202
1	engineer's hammer 300 g	1370
1	measuring tape 3 m	1692/3
1	snap - off blade utility knife 18 mm	1771
1	car service knife	1778SOS
1	high-brightness LED torch	1834PS

Beta N.

5915VU/1

Assortment of 45 tools

Universal use



5 kg

Quantity/Description

- 2 drift punches Ø 2-3 mm
- 1 centre punch Ø 4 mm
- 2 flat chisels 125-150 mm
- 1 cape chisels, standard type 150 mm
- 14 combination wrenches 6+14 - 17 - 19 - 21 - 22 - 24 mm
- 9 offset hexagon key wrenches
 ○ 1,5 - 2 - 2,5 - 3 - 4 - 5 - 6 - 8 - 10 mm
- 1 adjustable wrench 250 mm
- 1 Slip joint pliers boxed joints 250 mm
- 1 diagonal cutting nippers 160 mm
- 1 electrician's scissors, straight blades

Beta N.

- 30
- 32
- 34
- 36
- 42
- 96/SC9
- 111
- 1048
- 1082
- 1128BMX

Quantity/Description

- 1 half-round needle nose pliers 180 mm
- 1 screwdrivers for slotted head screws 160 mm
- 4 screwdrivers for cross head Phillips® screws
 ● 3x75 - 4x100 - 5,5x100 - 6,5x150 mm
- 3 screwdrivers for cross head Phillips® screws
 ⊕ PH0x60 - PH1x80 - PH2x100 mm
- 1 engineer's hammer 300 g
- 1 measuring tape 5 m
- 1 snap - off blade utility knife

Beta N.

- 1150
- 1166
- 1201
- 1202
- 1370
- 1692
- 1771

5915VU/1

059150124

Assortment recommended in combination with C9 - C10 - C10S - C11 - CP15 - CP15L - C16 - CP17 - CP17L - C18

Universal use



Quantity/Description

- 8 double open end wrenches 6x7 - 8x9 - 10x11 - 12x13 - 14x15
16x17 - 18x19 - 20x22 mm
- 9 offset hexagon key wrenches
○ 1,5 - 2 - 2,5 - 3 - 4 - 5 - 6 - 8 - 10 mm
- 13 1/4" hexagon sockets
○ 4 - 4,5 - 5 - 5,5 - 6 - 7 - 8 - 9 - 10 - 11 - 12 - 13 - 14 mm
- 1 1/4" drive extension bar 150 mm
- 1 1/4" drive universal joint
- 1 1/4" drive spinner handle
- 1 1/4" drive swivel T-handle
- 1 1/4" reversible ratchet

Beta N.

- 55/B8
- 96/SC9
- 900
- 900/21
- 900/25
- 900BG/30
- 900/42
- 900/55

Quantity/Description

- 1 Slip joint pliers boxed joints 250 mm
- 1 electrician's scissors, straight blades
- 1 half-round needle nose pliers 180 mm
- 4 screwdrivers for cross head Phillips® screws
● 3x75 - 4x100 - 5,5x150 - 6,5x150 mm
- 3 screwdrivers for cross head Phillips® screws
⊕ PH0x60 - PH1x80 - PH2x100 mm
- 1 engineer's hammer 300 g
- 1 measuring tape 3 m
- 1 plastic oil bottle 30 cc
- 1 snap - off blade utility knife 18 mm

Beta N.

- 1048
- 1128BMX
- 1150
- 1201
- 1202
- 1370
- 1692
- 1755
- 1771

5915VU/3

assortment of 74 tools

Universal use



8.1 kg

Quantity/Description

- 1 pin punches Ø 4 mm
- 1 centre punch Ø 4 mm
- 1 flat chisels 150 mm
- 14 combination wrenches 6÷17 - 19 - 22 - 24 mm
- 9 offset hexagon key wrenches \odot 1,5÷10 mm
- 3 offset hexagon key wrenches \odot 4 - 5 - 6 mm
- 1 adjustable wrench 250 mm
- 13 1/2" square drive hexagon sockets
 \odot 8÷17 - 19 - 22 - 24 mm
- 1 1/2" drive extension bar 255 mm
- 1 1/2" drive universal joint
- 1 1/2" drive sliding T-handle
- 1 1/2" drive reversible ratchet ®
- 8 double ended hexagon tubular socket wrenches, light series 6x7 - 8x9
- 10x11 - 12x13 - 14x15 - 16x17 - 18x19 - 20x22 mm
- 2 tommy bars for tubular wrenches
- 1 slip joint pliers 250 mm

Beta N.

- 31
- 32
- 34
- 42
- 96/SC9
- 96T
- 111
- 920A
- 920/22
- 920/25
- 920/42
- 920/55
- 935
- 940
- 1048V

Quantity/Description

- 1 self - locking pliers 240 mm
- 1 heavy duty diagonal cutting nippers ∇ 160 mm
- 1 electrician's scissors, straight blades
- 1 half-round needle nose pliers \equiv 180 mm
- 1 extra long needle knurled nose pliers, bi-material handles \bullet 160 mm
- 4 screwdrivers for cross head Phillips® screws \bullet 3x75 - 4x100 -
5,5x150 - 6,5x150 mm
- 3 screwdrivers for cross head Phillips® screws \bullet PH0x60 - PH1x80 -
PH2x100 mm
- 1 engineer's hammer 400 g
- 1 measuring tape 5 m
- 1 hacksaw frame, aluminium handle
- 1 plastic oil bottle 150 cc
- 1 snap - off blade utility knife

Beta N.

- 1052
- 1084BM
- 1128BMX
- 1150BM
- 1166BM
- 1201
- 1202
- 1370
- 1692
- 1726
- 1755
- 1771

5915VU/3

059150128

Assortment recommended in combination with C7 - C9 - C10 - C10S - C11 - CP15L - C16 - CP17 - CP17L - C19 - C19L - C20 - C20L

Universal use



11.2 kg

Quantity/Description

- 1 pin punches Ø 4 mm
- 1 centre punch Ø 4 mm
- 1 flat chisels 150 mm
- 15 combination wrenches 6+17 - 19 - 22 - 24 mm
- 9 offset hexagon key wrenches \odot 1,5+10 mm
- 1 adjustable wrench 250 mm
- 13 1/2" square drive hexagon sockets \odot 8+17 - 19 - 22 - 24 mm
- 1 1/2" drive extension bar 255 mm
- 1 1/2" drive universal joint
- 1 1/2" drive sliding T-handle
- 1 1/2" drive reversible ratchet \otimes
- 17 double ended hexagon/bi - hex offset socket wrenches 6+22 mm
- 1 Slip joint pliers boxed joints 250 mm
- 1 self - locking pliers 240 mm

Beta N.

- 31
- 32
- 34
- 42
- 96/SC9
- 111
- 920A
- 920/22
- 920/25
- 920/42
- 920/55
- 932/S17
- 1048
- 1052

Quantity/Description

- 1 heavy duty diagonal cutting nippers \leq 160 mm
- 1 electrician's scissors, straight blades
- 1 half-round needle nose pliers \equiv 180 mm
- 1 extra long needle knurled nose pliers, bi-material handles \bullet 160 mm
- 4 screwdrivers for cross head Phillips® screws \bullet 3x75 - 4x100 - 5,5x150 - 6,5x150 mm
- 3 screwdrivers for cross head Phillips® screws \oplus PH0x60 - PH1x80 - PH2x100 mm
- 1 riveting hammer 32 mm
- 1 measuring tape 5 m
- 1 hacksaw frame, aluminium handle
- 1 plastic oil bottle 150 cc
- 1 snap - off blade utility knife

Beta N.

- 1084BM
- 1128BMX
- 1150BM
- 1166BM
- 1201
- 1202
- 1370F
- 1692
- 1726
- 1755
- 1771

5915VU/4

059150145

Assortment recommended in combination with C20 - C20L

5915VU/5

assortment of 111 tools

Universal use



Quantity/Description

1	pin punches Ø 4 mm
1	centre punch Ø 4 mm
1	flat chisels 150 mm
17	combination wrenches 6-7-8-9-10-11-12-13-14-15-16-17-18-19-20-21-22 mm
8	double open end wrenches 6x7-8x9-10x11-12x13-14x15-16x17-18x19-20x22 mm
1	adjustable wrench 250 mm
9	ball head offset hexagon key wrenches ○
39	11 hexagon sockets, 20 bits and 8 accessories
13	11 sockets and 2 accessories
1	Slip joint pliers boxed joints 250 mm
1	self - locking pliers 240 mm
1	diagonal cutting nippers 160 mm

Beta N.

31
32
34
42
55/S8
111
96BPC/SC9
900/C11
920A/C11
1048
1052
1082

Quantity/Description

1	construction worker's pincers 220 mm
1	electrician's scissors, straight blades
1	half-round needle nose pliers = 180 mm
1	screwdrivers for slotted head screws 160 mm
3	screwdrivers for cross head Phillips® screws PH0x60 - PH1x80 - PH2x100 mm
1	engineer's hammer 300 g
1	soft face hammer Ø 35 mm
1	measuring tape 3 m
1	second cut files
1	hacksaw frame, aluminium handle 440 mm
1	snap - off blade utility knife 18 mm
1	LED inspection torch

Beta N.

1098
1128BMX
1150
1166
1202
1370
1390
1692/3
1719BMA8/M
1726
1771BM
1835/2

5915VU/5

059150156

Assortment recommended in combination with C12

5915VU/AS

assortment of 68 tools

Universal use



9.3 kg

Quantity/Description

- 1 pin punches Ø 4 mm
- 1 centre punch Ø 4 mm
- 1 flat chisels 150 mm
- 13 combination wrenches 1/4 - 5/16 - 3/8 - 7/16 - 1/2 - 9/16 - 5/8 - 11/16 - 3/4 - 13/16 - 7/8 - 15/16 - 1"
- 8 double ended offset ring wrenches 1/4"÷1"
- 9 ○ 3/64"÷3/8"
- 1 adjustable wrench 250 mm
- 11 1/2" square drive bi - hex sockets ○ 3/8 - 7/16 - 1/2 - 9/16 - 5/8 - 11/16 - 3/4 - 13/16 - 7/8 - 15/16 - 1"
- 1 1/2" drive extension bar 255 mm
- 1 1/2" drive universal joint
- 1 1/2" drive sliding T-handle
- 1 1/2" drive reversible ratchet
- 1 slip joint pliers 250 mm
- 1 self - locking pliers 240 mm

Beta N.

- 31
- 32
- 34
- 42AS
- 90AS/8
- 96AS/SC9
- 111
- 920AS
- 920/22
- 920/25
- 920/42
- 920/55
- 1048V
- 1052

Quantity/Description

- 1 heavy duty diagonal cutting nippers 160 mm
- 1 electrician's scissors, straight blades
- 1 half-round needle nose pliers 180 mm
- 1 extra long needle knurled nose pliers, bi-material handles 160 mm
- 4 screwdrivers for cross head Phillips® screws
- 3x75 - 4x100 - 5,5x150 - 6,5x150 mm
- 3 screwdrivers for cross head Phillips® screws
- ⊕ PH0x60 - PH1x80 - PH2x100 mm
- 1 engineer's hammer 300 g
- 1 measuring tape 5 m
- 1 hacksaw frame, aluminium handle
- 1 plastic oil bottle 150 cc
- 1 snap - off blade utility knife

Beta N.

- 1084BM
- 1128BMX
- 1150BM
- 1166BM
- 1201
- 1202
- 1370
- 1692
- 1726
- 1755
- 1771

5915VU/AS

059150132

Assortment recommended in combination with C10 - C20 - C20L

Universal use

Quantity/Description	Beta N.	TR	Quantity/Description	Beta N.	TR
16 combination wrenches 6-7-8-9-10-11-12-13-14-15-16-17-18-19-21-22 mm	42	MC10	1 cape chisels, standard type 4 mm	36	MC20
9 offset hexagon key wrenches	96/SC9	MC10	13 1/4" hexagon sockets	900	MC20
○ 1,5-2-2,5-3-4-5-6-8-10 mm			○ 4-4,5-5-5,5-6-7-8-9-10-11-12-13-14 mm		
1 heavy duty diagonal cutting nippers 160 mm	1084BM	MC10	1 1/4" drive extension bar 150 mm	900/21	MC20
1 half-round needle nose pliers 180 mm	1150BM	MC10	1 1/4" drive universal joint	900/25	MC20
1 extra long needle knurled nose pliers, bi-material handles 160 mm	1166BM	MC10	1 1/4" drive spinner handle	900BG/30C	MC20
3 screwdrivers for cross head Phillips® screws	1201	MC10	1 1/4" drive swivel T-handle	900/42	MC20
● 3,5x100-5,5x150-6,5x150 mm			1 1/4" reversible ratchet	900/55	MC20
3 screwdrivers for cross head Phillips® screws	1202	MC10	16 1/2" square drive hexagon sockets ○ 10-11-12-13-14-15-16-17-18-19-21-22-24-27-30-32 mm	920A	MC20
⊕ PH0x3x60-PH1x4,5x80-PH2x6x100 mm			1 1/2" drive universal joint	920/25	MC20
31 bits with magnetic quick release bit holder in plastic case	860MIX/A31	MC20	1 1/2" wobble extension bar 125 mm	920AN/125	MC20
● ○ ⊕ ⊕ ⊕			1 1/4" drive swivel T-handle	900/42	MC20
1 Slip joint pliers boxed joints 250 mm	1048	MC20	1 1/4" reversible ratchet	900/55	MC20
1 engineer's hammer 300 mm	1370	MC20	1 socket holder	895/1	MC20
1 centre punch 4 mm	32	MC20			

Universal use



MB11



MB35

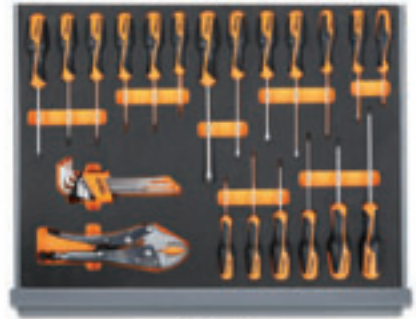

MB45



MB56

Quantity/Description

- 21 combination wrenches 6-7-8-9-10-11-12-13-14-15-16-17-18-19-20-21-22-24-27-30-32 mm
- 8 double open end wrenches 6x7-8x9-10x11-12x13-14x15-16x17-18x19-20x22 mm
- 1 Slip joint pliers boxed joints 250 mm
- 8 offset hexagon key wrenches \odot 2-2,5-3-4-5-6-7-8 mm
- 1 magnetic bit holder with handle 230 mm
- 5 bits for slotted head screws, coloured
- 8 hexagon bits for power drivers, coloured
- 5 bits for cross head Phillips® screws, coloured
- 4 bits for cross head Pozidriv® - Supadriv® screws, coloured \oplus PZ1 - PZ2 - PZ3 - PZ4
- 8 bits for Tamper Resistant Torx® head screws, coloured \otimes T9-T10-T15-T20-T25-T27-T30-T40
- 11 bits for Torx® head screws, coloured \odot T6-T7-T8-T9-T10-T15-T20-T25-T27-T30-T40
- 1 reversible bit ratchet 100 mm
- 1 magnetic bit holder extension bar 80 mm
- 1 adaptors for drivers
- 18 1/2" square drive hexagon sockets \odot 10-11-12-13-14-15-16-17-18-19-20-21-22-24-26-27-30-32 mm
- 1 1/2" wobble extension bar 125 mm
- 1 1/2" wobble extension bar 250 mm
- 1 1/2" drive universal joint
- 1 1/2" drive sliding T-handle
- 1 1/2" drive reversible ratchet \otimes
- 1 heavy duty diagonal cutting nippers \nless 160 mm
- 1 half-round needle nose pliers \equiv 180 mm

Beta N.	TR
42	MB11
55	MB11
1048	MB11
96T	MB35
851SR	MB35
860LP	MB35
860PE	MB35
860PH	MB35
860PZ	MB35
860RTX	MB35
860TX	MB35
860/55	MB35
882P	MB35
892/0	MB35
920A	MB35
920AN/125	MB35
920AN/250	MB35
920/25	MB35
920/42	MB35
920/55	MB35
1084BM	MB35
1150BM	MB35

Quantity/Description

- 1 extra long needle knurled nose pliers, bi-material handles \bullet 160 mm
- 7 screwdrivers for cross head Phillips® screws \bullet 2,5x50-3x75-3,5x100-4x100-5,5x100-5x125-6,5x150 mm
- 6 screwdrivers for cross head Phillips® screws \oplus PH0x60-PH0x100-PH1x80-PH1x120-PH2x100-PH2x150 mm
- 6 drivers for Torx® head screws \odot T8-T10-T15-T20-T25-T30
- 1 self - locking pliers 240 mm
- 9 ball head offset hexagon key wrenches \odot
- 1 second-cut square files 200 mm
- 1 second-cut triangular files 200 mm
- 1 second-cut flat files 200 mm
- 1 second-cut half-round files 200 mm
- 1 second-cut round files 200 mm
- 1 circlip pliers straight, internal \odot 180 mm
- 1 circlip pliers bent, internal \odot 170 mm
- 1 circlip pliers straight, external \bullet 175 mm
- 1 circlip pliers bent, external \bullet 175 mm
- 1 mechanic's hammers 300 g
- 1 nylon face hammers, wooden shafts \varnothing 35 mm
- 1 flat chisels, ribbed type 200 mm
- 1 measuring tape 5 mt
- 1 hacksaw frame, aluminium handle 260 mm
- 1 snap - off blade utility knife 18 mm

Beta N.	TR
1166BM	MB35
1260	MB45
1262	MB45
1267TX	MB45
1052	MB45
96BPC/SC9	MB45
1719BMA...Q	MB56
1719BMA...T	MB56
1719BMA...P	MB56
1719BMA...M	MB56
1719BMA...R	MB56
1032	MB56
1034	MB56
1036	MB56
1038	MB56
1370T	MB56
1390N	MB56
35	MB56
1692	MB56
1725	MB56
1771	MB56

Universal maintenance

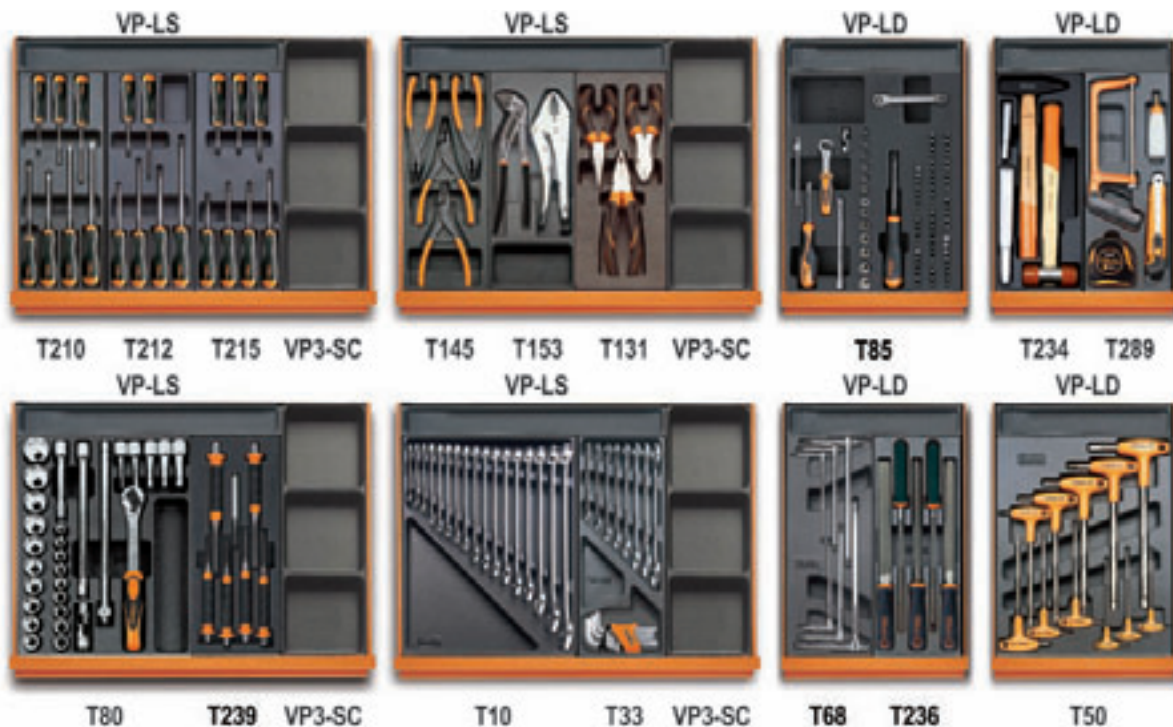

Quantity/Description	Beta N.	TR	Quantity/Description	Beta N.	TR
7 screwdrivers for cross head Phillips® screws ● 2,5x50 - 3x75 - 3,5x100 - 4x125	1201	T210	3 bits for cross head Pozidriv®-Supadriv® screws	861PZ	T85
5,5x100 - 5,5x150 - 6,5x150 mm			● PZ1 - PZ2 - PZ3		
6 screwdrivers for cross head Phillips® screws ⊕ PH0x60- PH1x80-PH1x120-PH2x100-PH2x150-PH3x150 mm	1202	T212	4 bits for cross head Phillips® screws ⊕ PH0 - PH1 - PH2 - PH3	861PH	T85
7 drivers for Torx® head screws, with handles ○ T6-T7-T8-T9-T10-T15-T20	1207TX	T215	8 hexagon bits for power drivers	861PE	T85
1 circlip pliers straight, internal ○ 180 mm	1032	T145	7 bits for slotted head screws ● 0,5x3 - 0,6x4,5 - 0,8x5,5 - 1x5,5 - 1,2x6,5 - 1,2x8 - 1,6x8 mm	861LP	T85
1 circlip pliers bent, internal ○ 170 mm	1034	T145	2 flat chisels, ribbed type 100 - 200 mm	35	T234
1 circlip pliers straight, external ● 175 mm	1036	T145	1 engineer's hammer 300 g	1370	T234
1 circlip pliers bent, external ● 175 mm	1038	T145	1 soft face hammer Ø 35 mm	1390	T234
1 Slip joint pliers boxed joints 240 mm	1048	T153	1 measuring tape 5 m	1692	T289
1 self - locking pliers 240 mm	1052	T153	1 mini hacksaw frame	1725CR	T289
1 heavy duty diagonal cutting nippers ≤ 160 mm	1084BM	T131	1 plastic oil bottle	1755	T289
1 half-round needle nose pliers = 180 mm	1150BM	T131	1 snap - off blade utility knife	1771	T289
1 extra long needle knurled nose pliers, bi-material handles ● 160 mm	1166BM	T131	19 1/2" square drive hexagon sockets ○ 10 - 11 - 12÷19 - 20 - 21 - 22 - 23 - 24 - 26 - 27 - 30 - 32 mm	920A	T80
1 reversible ratcheting wrench for bits 1/4x5/16	194	T85	5 1/2" drive, socket drivers for hexagon screws	920ME	T80
13 1/4" hexagon sockets	900	T85	○ 5 - 6 - 8 - 10 - 12 mm		
○ 4-4,5-5-5,5-6-7-8-9-10-11-12-13-14 mm			1 1/2" drive extension bar 125 mm	920/21	T80
1 1/4" reversible ratchet ⊕ 125 mm	900/55	T85	1 1/2" drive extension bar 255 mm	920/22	T80
1 1/4" drive swivel T-handle 115 mm	900/42	T85	1 1/2" drive universal joint	920/25	T80
1 1/4" drive spinner handle 176 mm	900BG/30	T85	1 1/2" drive sliding T-handle	920/42	T80
1 1/4" drive universal joint 41 mm	900/25	T85	1 1/2" drive reversible ratchet ⊕	920/55	T80
1 1/4" drive extension bar 150 mm	900/21	T85	1 centre punch Ø 4 mm	32	T239
1 magnetic bit holder with handle 230 mm	851SR	T85	6 pin punches with handles 2-3-4-5-6-8 mm	31BM	T239
5 bits for Spanner screws ⊕ 4-6-8-10-12 mm	861SP	T85	17 combination wrenches 6-7-8-10-11-12-13-14-16-17-18-19-21-22-24-27-30 mm	42	T10
8 bits for Torq-Set® head screws ⊕ 0-1-2-3-4-5-6-8 mm	861TQS	T85	8 double open end wrenches 6x7 - 8x9 - 10x11 - 12x13 - 14x15 - 16x17 - 18x19 - 20x22 mm	55	T33
6 bits for Tri-Wing® head screws ⊕ 1-2-3-4-5-6 mm	861TRW	T85	9 offset hexagon key wrenches ○	96/SC9	T33
8 bits for Tamper Resistant Torx® head screws ⊕ T9-T10-T15-T20-T25-T27-T30-T40	861TRX	T85	6 T-handle wrenches with hexagon male ends ○ 2,5 - 3 - 4 - 5 - 6 - 8 mm	951	T68
11 bits for Torx® head screws ⊕ T6-T7-T8-T9-T10-T15-T20-T25-T27-T30-T40	861TX	T85	5 second cut files 200 mm	1719BMA8/S5	T236
			11 offset hexagon key wrenches	96T	T50
			○ 2 - 2,5 - 3 - 3,5 - 4 - 4,5 - 5 - 6 mm		
			4 thermoformed trays, empty		VP-3SCVP-3SC
			4 thermoformed trays, empty		VP-LS VP-LS
			4 thermoformed trays, empty		VP-LD VP-LD

Universal use



Quantity/Description

2	drift punches 2 - 3 mm
6	pin punches 2-3-4-5-6-8 mm
1	centre punch 4 mm
2	flat chisels 125 - 150 mm
1	cape chisels, standard type 150 mm
17	combination wrenches 6-7-8-9-10-11-12-13-14-15-16-17-18-19-20-21-22-24 mm
12	double open end wrenches 6x7-8x9-10x11-12x13-14x15-16x17-18x19-20x22-21x23-24x27-25x28-30x32 mm
8	offset hexagon key wrenches 2-2,5-3-4-5-6-8-10 mm
8	offset key wrenches T9-T10-T15-T20-T25-T27-T30-T40
1	adjustable wrench 250 mm
21	1/2" square drive hexagon sockets 10-11-12-13-14-15-16-17-18-19-20-21-22-23-24-25-26-27-28-30-32 mm
4	1/2" socket drivers for slotted head screws ● 1,2x65-1,2x8-1,6x9-2x12 mm
3	1/2" socket drivers for Phillips® screws ● PH1-PH2-PH3
1	1/2" drive extension bar 125 mm
1	1/2" drive extension bar 250 mm
1	1/2" drive universal joint
1	1/2" drive sliding T-handle
1	1/2" drive reversible ratchet ⊕
1	pry bar
1	circlip pliers straight, internal ⊖ 180 mm
1	circlip pliers bent, internal ⊖ 170 mm
1	circlip pliers straight, external ● 175 mm

Beta N.

30
31
32
34
36
42
55
96T
97TX
111
920A
920LP
920PH
920/21
920/22
920/25
920/42
920/55
963
1032
1034
1036

Quantity/Description

1	circlip pliers bent, external ● 175 mm
1	Slip joint pliers boxed joints 250 mm
1	self - locking pliers 240 mm
1	diagonal cutting nippers ⊚ 160 mm
1	heavy duty diagonal cutting nippers ⊚ 160 mm
1	toggle lever assisted end cutting nippers ⊚ 180 mm
1	tin snips 250 mm
1	electrician's scissors, straight blades
1	half-round needle nose pliers = 180 mm
1	extra long needle knurled nose pliers, bi-material handles ● 160 mm
1	bent needle nose pliers ● 160 mm
7	screwdrivers for cross head Phillips® screws ● 2,5x75 - 3x75 - 4x125 - 5,5x100 - 6,5x150 - 8x200 - 10x200 mm
4	screwdrivers for cross head Phillips® screws ⊕ PH0x60- PH1x80 - PH2x100 - PH3x150 mm
2	engineer's hammer 300 - 600 g
1	soft face hammer 35
1	sliding gauge
1	measuring tape 5 m
1	flexible magnetic pick-up tool
1	two cutting edges scraper 200 mm
1	three - cutting edges scraper 200 mm
5	200 mm
1	hacksaw frame, aluminium handle 420 mm
1	snap - off blade utility knife

Beta N.

1038
1048
1052
1082BM
1084BM
1092V
1112
1128BMX
1150BM
1166BM
1168BM
1260
1262
1370
1390
1650
1692/5
1712E/2
1717A
1717B
1719BMA/S5
1725
1771BM

5958U

Assortment of 86 tools

Universal use



11.3 kg

Quantity/Description

- 18 combination wrenches 5,5+22 mm
- 12 offset hexagon key wrenches \odot 2+10 mm
- 13 1/2" square drive hexagon sockets with rail \odot 10+22 mm
- 8 1/2" square drive hexagon sockets with rail \odot 23+32 mm
- 1 1/2" drive extension bar 125 mm
- 1 1/2" drive extension bar 255 mm
- 1 1/2" drive universal joint
- 1 1/2" drive sliding T-handle
- 1 1/2" drive reversible ratchet \oplus
- 1 circlip pliers straight, internal \odot 180 mm
- 1 circlip pliers straight, external \bullet 175 mm
- 1 Slip joint pliers boxed joints 250 mm
- 1 self - locking pliers 240 mm
- 1 heavy duty diagonal cutting nippers ∇ 160 mm
- 1 electrician's scissors, straight blades
- 1 half-round needle nose pliers \equiv 180 mm

Beta N.

- 42
- 96N/SC12
- 920A/SB13
- 920A/SB8
- 920/21
- 920/22
- 920/25
- 920/42
- 920/55
- 1032
- 1036
- 1048
- 1052
- 1084BM
- 1128BMX
- 1150BM

Quantity/Description

- 1 extra long needle knurled nose pliers, bi-material handles \bullet 160 mm
- 7 screwdrivers for cross head Phillips® screws
 - \bullet 3x75 - 3,5x100 - 4x125
 - 5,5x150 - 6,5x150 - 8x200 - 10x200 mm
- 4 screwdrivers for cross head Phillips® screws \oplus PH0x60 - PH1x80
 - PH2x100 - PH3x150 mm
- 1 engineer's hammer 300 g
- 1 soft face hammer \varnothing 35 mm
- 1 measuring tape 5 m
- 5 second cut files 200 mm
- 1 hacksaw frame, aluminium handle
- 1 plastic oil can 150 cc
- 1 snap - off blade utility knife

Beta N.

- 1166BM
- 1260
- 1262/S4
- 1370
- 1390
- 1692
- 1719BMA/S5
- 1725
- 1754
- 1771

5958U

059580028

Assortment recommended in combination with C58P

Universal use

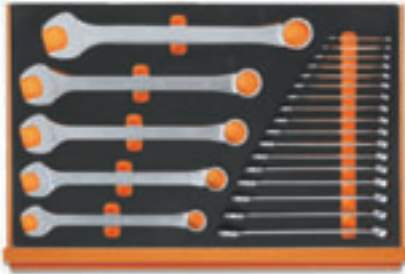

M10



M30



M210



M230



M130

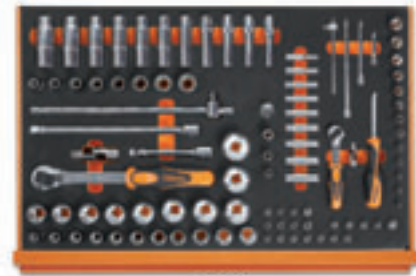

M100

Quantity/Description

- 22 combination wrenches 6-7-8-9-10-11-12-13-14-15-16-17-18-19-20-21-22-24-27-30-32-36 mm
- 11 double open end wrenches 6x7-8x9-10x11-12x13-14x15-16x17-18x19-20x22-21x23-24x27-30x32 mm
- 11 double ended offset ring wrenches 6x7-8x9-10x11-12x13-14x15-16x17-18x19-20x22-21x23-24x27-30x32 mm
- 9 ball head offset hexagon key wrenches
- 6 screwdrivers for cross head Phillips® screws
- 1 2,5x50-3x75-4x100-5,5x125-6,5x150-8x200 mm
- 1 screwdrivers for slotted head screws, extra-short series 4x30 mm
- 4 screwdrivers for cross head Phillips® screws
- 1 PH0x60-PH1x80-PH2x100-PH3x150 mm
- 1 screwdrivers for cross head Phillips® screws, extra-short series PH1x30 mm
- 12 drivers for Torx® head screws, with handles T6-T7-T8-T9-T10-T15-T20-T25-T27-T30-T40-T45
- 1 mains testing screwdriver
- 3 drift punches Ø 2-3-4 mm
- 6 pin punches Ø 2-3-4-5-6-8 mm
- 1 centre punch Ø 4 mm
- 1 flat chisels 150 mm
- 2 flat chisels, ribbed type 200-250 mm
- 1 cape chisels, standard type 125 mm
- 1 engineer's hammer 500 g
- 1 soft face hammer Ø 35 mm
- 1 measuring tape 3 m
- 1 telescopic magnet with flexible head
- 1 second-cut square files 200 mm
- 1 second-cut triangular files 200 mm
- 1 second-cut flat files 200 mm
- 1 second-cut half-round files 200 mm
- 1 second-cut round files 200 mm
- 1 brake shoe cleaning brush plastic handle steel wires
- 1 snap - off blade utility knife 18 mm
- 1 circlip pliers straight, internal Ø 180 mm
- 1 circlip pliers bent, internal Ø 170 mm
- 1 circlip pliers straight, external ● 175 mm
- 1 circlip pliers bent, external ● 175 mm
- 1 Slip joint pliers boxed joints 250 mm

Beta N.

TR

Quantity/Description

- 42 M10
- 55 M30
- 90 M30
- 96BPC/SC9 M30
- 1201 M210
- 1201N M210
- 1202 M210
- 1202N M210
- 1207TX M210
- 1253 M210
- 30 M230
- 31 M230
- 32 M230
- 34 M230
- 35 M230
- 36 M230
- 1370 M230
- 1390 M230
- 1692 M230
- 1712TF M230
- 1719BMA...Q M230
- 1719BMA...T M230
- 1719BMA...P M230
- 1719BMA...M M230
- 1719BMA...R M230
- 1737NX M230
- 1771 M230
- 1032 M130
- 1034 M130
- 1036 M130
- 1038 M130
- 1048 M130

Beta N.

TR

- 1 self - locking pliers 240 mm
- 1 diagonal cutting nippers 160 mm
- 1 construction worker's pincers 220 mm
- 1 tin snips 250 mm
- 1 electrician's scissors, straight blades
- 1 half-round needle nose pliers 180 mm
- 1 extra long needle knurled nose pliers, bi-material handles ● 160 mm
- 1 bent needle nose pliers ● 160 mm
- 1 socket holder
- 1 socket holder
- 1 socket holder
- 13 1/4" hexagon sockets Ø 4-4,5-5-5,5-6-7-8-9-10-11-12-13-14 mm
- 9 hexagon hand sockets, long series Ø 5-6-7-8-9-10-11-12-13 mm
- 5 1/4" socket drivers for hexagon screws Ø 3-4-5-6-7 mm
- 4 socket drivers for slotted head screws ● 0,8x4-1x5,5-1,2x6,5-1,2x8 mm
- 4 socket drivers for cross head Phillips® screws ● PH1-PH2-PH3-PH4
- 7 socket drivers for Torx® head screws T10-T15-T20-T25-T27-T30-T40
- 1 1/4" drive extension bar 50 mm
- 1 1/4" drive extension bar 100 mm
- 1 1/4" drive extension bar 150 mm
- 1 1/4" drive universal joint
- 1 1/4" drive spinner handle
- 1 1/4" drive swivel T-handle
- 1 1/4" reversible ratchet ⊕
- 21 1/2" square drive hexagon sockets Ø 8-10-11-12-13-14-15-16-17-18-19-20-21-22-23-24-26-27-28-30-32 mm
- 1 125 mm
- 1 1/2" drive universal joint 250 mm
- 1 1/2" wobble extension bar
- 1 1/2" wobble extension bar
- 1 1/2" drive sliding T-handle
- 1 1/2" drive reversible ratchet ⊕
- 8 1/2" sockets for Torx® head screws
- 10-12-14-16-18-20-22-24 mm
- 11 hexagon hand sockets, long series Ø 10-12-13-14-15-16-17-18-19-21-22 mm
- 1052 M130
- 1082BM M130
- 1098 M130
- 1112 M130
- 1128BM M130
- 1150BM M130
- 1166BM M130
- 1168BM M130
- 895/1 M100
- 895/3 M100
- 895/6 M100
- 900 M100
- 900L M100
- 900ME M100
- 900LP M100
- 900PH M100
- 900TX M100
- 900/20 M100
- 900/20L M100
- 900/21 M100
- 900/25 M100
- 900BG/30 M100
- 900/42 M100
- 900/55 M100
- 920A M100
- 920/15 M100
- 920/25 M100
- 920AN/125 M100
- 920AN/250 M100
- 920/42 M100
- 920/55 M100
- 920FTX M100
- 920AL M100

Electrotechnical maintenance



MB57



MB62



MB63

Quantity/Description

- 2 pin punches Ø 4-6 mm
- 1 centre punch Ø 4 mm
- 2 flat chisels, ribbed type 125-200 mm
- 1 engineer's hammer 300 g
- 1 soft face hammer Ø 35 mm
- 1 measuring tape 5 m
- 1 second-cut round files 200 mm
- 1 second-cut half-round files 200 mm
- 1 second-cut flat files 200 mm
- 1 second-cut triangular files 200 mm
- 1 second-cut square files 200 mm
- 1 hacksaw frame, aluminium handle 420 mm
- 1 flash light
- 8 double open end wrenches 6x7-8x9-10x11-12x13-14x15-16x17-18x19-20x22 mm
- 1 slip joint pliers, boxed joint 250 mm
- 1 diagonal cutting nippers 1000V ⚡ 140 mm
- 1 electrician's scissors, straight blades, with countersink
- 1 cable cutter 230 mm
- 1 wire stripping pliers ⚡ 160 mm
- 1 combination pliers 1000V = 180 mm
- 1 extra long needle nose pliers, 1000V, ⚡ 160 mm

- | Beta N. | TR |
|-------------|-------------|
| 31 | MB57 |
| 32 | MB57 |
| 35 | MB57 |
| 1370 | MB57 |
| 1390 | MB57 |
| 1692 | MB57 |
| 1719BMA...R | MB57 |
| 1719BMA...M | MB57 |
| 1719BMA...P | MB57 |
| 1719BMA...T | MB57 |
| 1719BMA...Q | MB57 |
| 1725 | MB57 |
| 1835 | MB57 |
| 55 | MB62 |
| 1048MQ | MB62 |
| 1082MQ | MB62 |
| 1128BSX | MB62 |
| 1132MQ | MB62 |
| 1142MQ | MB62 |
| 1150MQ | MB62 |
| 1166MQ | MB62 |

Quantity/Description

- 1 extra long bent needle nose pliers ⚡ 160 mm
- 1 adjustable wrench, 1000V 250 mm
- 1 utility knife, 1000V
- 1 bent knurled point spring tweezers, 1000V
- 1 crimping pliers for insulated terminals
- 9 ball head offset hexagon key wrenches ⚡
- 1 screwholding screwdriver for slotted head screws ⚡
- 1 screwholding screwdriver for cross head Phillips® screws ⚡
- 1 mains testing screwdriver ⚡
- 6 hexagon nut spinners with handles ⚡ 5,5-6-7-8-10-13 mm
- 4 screwdrivers for cross head Phillips® screws, 1000V ⚡ PH0x60-PH1x80-PH2x100-PH3x150 mm
- 6 screwdrivers for headless slotted screws, 1000V ⚡ 2,5x75-3x100-4x100-5,5x125-6x150-8x175 mm
- 31 bits with magnetic quick release bit holder in plastic case ⚡
- 1 magnetic bit holder, insulated ⚡

- | Beta N. | TR |
|------------|-------------|
| 1168MQ | MB62 |
| 110MQ | MB62 |
| 1777MQ | MB62 |
| 993MQ | MB62 |
| 1602 | MB62 |
| 96BPC/SC9 | MB63 |
| 1250 | MB63 |
| 1251 | MB63 |
| 1253 | MB63 |
| 943MQ | MB63 |
| 1272MQ | MB63 |
| 1274MQ | MB63 |
| 860MIX/A31 | MB63 |
| 850MQ | MB63 |

Electrotechnical maintenance



7.9 kg

Quantity/Description

- 1 centre punch Ø 4 mm
- 1 flat chisels, ribbed type 150 mm
- 8 double open end wrenches 6x7 - 8x9 - 10x11 - 12x13 - 14x15 - 16x17 - 18x19 - 20x22 mm
- 8 offset hexagon key wrenches, long series 1,5+12 mm
- 1 adjustable wrench 200 mm
- 1 magnetic bit holder, insulated
- 10 bits with magnetic bit holder in plastic case
- 1 slip joint pliers, boxed joint 250 mm
- 1 diagonal cutting nippers 160 mm
- 1 electrician's scissors, straight blades, with countersink
- 1 cable cutter 170 mm
- 1 half-round needle nose pliers 180 mm
- 1 extra long needle knurled nose pliers, bi-material handles 160 mm
- 1 bent needle nose pliers 160 mm
- 1 screwholding screwdriver for slotted head screws 4x125 mm
- 1 screwholding screwdriver for cross head Phillips® screws PH1x150 mm

Beta N.

- 32
- 35
- 55/B8
- 96LC/SC8
- 111
- 850MQ
- 860MIX/A10
- 1048MQ
- 1082BM
- 1128BSX
- 1132BM
- 1150BM
- 1166BM
- 1168BM
- 1250
- 1251

Quantity/Description

- 1 mains testing screwdriver
- 5 screwdrivers for cross head Phillips® screws 2,5x75 - 3,5x100 - 5,5x125 - 6,5x150 mm
- 1 screwdrivers for slotted head screws, extra-short series 4x30 mm
- 4 screwdrivers for cross head Phillips® screws PH0x60 - PH1x120 - PH2x150 - PH3x150 mm
- 1 screwdrivers for cross head Phillips® screws, extra-short series PH2x30 mm
- 4 screwdrivers for cross head Phillips® screws, 1000V PH0x60 - PH1x80 - PH2x100 - PH3x150 mm
- 5 screwdrivers for headless slotted screws, 1000V 5,5x125 - 3x100 - 4x100 - 6,5x150 - 8x175 mm
- 1 flat chisel with side cutter
- 1 engineer's hammer 300 g
- 1 soft face hammer Ø 35 mm
- 1 crimping pliers for insulated terminals
- 1 friction tape 25 m
- 1 measuring tape 5 m
- 1 second-cut half-round files 200 mm
- 1 second-cut round files 200 mm
- 1 hacksaw frame, aluminium handle
- 1 fold - away knife

Beta N.

- 1253
- 1201
- 1201N
- 1202
- 1202N
- 1272MQ
- 1274MQ
- 1343
- 1370
- 1390
- 1602
- 1639NS-N
- 1692
- 1719BMA/M
- 1719BMA/R
- 1725
- 1777BM

5980ET/B

assortment of 64 tools

Electrotechnical maintenance



3.7 kg

Quantity/Description

3	pin punches Ø 2 - 3 - 4 mm	31
1	centre punch Ø 4 mm	32
1	flat chisels 150 mm	34
8	double open end wrenches 6x7 - 8x9 - 10x11 - 12x13 - 14x15 - 16x17 - 18x19 - 20x22 mm	55/B8
9	ball head offset hexagon key wrenches ○ 1,5 - 2 - 2,5 - 3 - 4 - 5 - 6 - 8 - 10 mm	96BPC/SC9
1	deburrer 150 mm	345SB
6	hexagon nut spinners with handles 1000V ○ 5,5 - 6 - 7 - 8 - 10 - 13 mm	943MQ/S6
1	slip joint pliers, boxed joint 250 mm	1048MQ
1	diagonal cutting nippers 1000V ✂ 160 mm	1082MQ
1	electrician's scissors, straight blades, with countersink	1128BSX
1	cable cutter 230 mm	1132MQ
1	wire stripping pliers 160 mm	1142MQ
1	combination pliers 1000V = 180 mm	1150MQ
1	extra long needle nose pliers, 1000V, ● 160 mm	1166MQ
1	mains testing screwdriver ●	1253
3	screwdrivers for cross head Phillips® screws, 1000V ⊕ PH0x60 - PH1x80 - PH2x100 mm	1272MQ
4	screwdrivers for headless slotted screws, 1000V ● 3x100 - 4x100 - 5,5x125 - 6,5x150 mm	1274MQ

Beta N.

Quantity/Description

1	engineer's hammer 300 g	1370
1	soft face hammer Ø 35 mm	1390
1	crimping pliers for insulated terminals	1602
1	flexible graduated rule 250 mm	1682
1	engineer's scriber 250 mm	1688
1	measuring tape 5 m	1692
1	spirit level, made of aluminium 200 mm	1696
1	electrician's chisel 10x200 mm	1701NE/3
1	chalk line reel	1705
1	square flexible inspection mirror 600 mm	1715FL/A
1	200 mm	1719BMA/M
1	second cut files 200 mm	1719BMA/R
1	spring puller	1723
1	hacksaw frame, aluminium handle	1726BM
1	bristle brush	1738
1	fitting tool for nylon ties	1743
1	plastic oil bottle 80 cc	1755
100	nylon cable ties 3,6x200 mm	1748/8K
100	nylon cable ties 4,8x300 mm	1748/17K
1	snap - off blade utility knife	1771BM
1	soldering iron 30 W	1814M
1	LED inspection torch	1835/2

5980 ET/B

059800263

Assortment recommended in combination with C12 - 2029/VV - 2033P/VV - 2036TV

5980/MQ

assortment of 46 tools

Electrotechnical maintenance



7 kg

Quantity/Description

- 7 single open end wrenches, 1000V 10 - 12 - 13 - 14 - 17 - 19 - 22 mm
- 1 adjustable wrench, 1000V 250 mm
- 6 hexagon nut spinners with handles \varnothing 5,5 - 6 - 7 - 8 - 10 - 13 mm
- 4 T-handle wrenches with hexagon male ends \varnothing 4 - 5 - 6 - 8 mm
- 1 bent knurled point spring tweezers, 1000V
- 1 slip joint pliers, boxed joint 250 mm
- 1 diagonal cutting nippers 1000V \angle 160 mm
- 1 electrician's scissors
- 1 wire stripping pliers \angle 160 mm
- 1 combination pliers 1000V \equiv 180 mm
- 1 extra-long bent flat nose pliers \equiv 160 mm
- 1 extra long needle nose pliers, 1000V, \bullet 160 mm

Beta N.

- 52MQ
- 110MQ
- 943MQ
- 951MQ
- 993MQ
- 1048MQ
- 1082MQ
- 1128MQ
- 1142MQ
- 1150MQ
- 1164MQ
- 1166MQ

Quantity/Description

- 1 mains testing screwdriver \bullet
- 4 screwdrivers for cross head Phillips® screws, 1000V \oplus PH0x60 - PH1x80 - PH2x100 - PH3x150 mm
- 5 screwdrivers for headless slotted screws, 1000V \bullet 3x100 - 4x100 - 5,5x125 - 6,5x150 - 8x175 mm
- 1 engineer's hammer 300 g
- 1 soft face hammer \varnothing 35 mm
- 1 measuring tape 5 m
- 1 200 mm
- 1 mini - hacksaw frame, 1000V
- 1 utility knife, 1000V
- 1 soldering iron 30 W
- 1 high-brightness LED torch
- 1 combination voltage and continuity tester

Beta N.

- 1253
- 1272MQ
- 1274MQ
- 1370
- 1390
- 1692
- 1701NE/3
- 1725MQ
- 1777MQ
- 1814M
- 1834PS
- 1847P

5980MQ

059800257

5980EL/A

assortment of 57 tools

Electronics



Quantity/Description

- 13 small double open end wrenches 4÷14 mm
- 9 offset hexagon key wrenches \varnothing 1,5÷10 mm
- 1 bent point tweezers 130 mm
- 1 straight thin knurled point pin spring tweezers 150 mm
- 1 cross tweezers 155 mm
- 1 electrician's scissors, straight blades, with countersink
- 1 wire stripping pliers \downarrow 160 mm
- 1 extra long needle knurled nose pliers, bi-material handles \bullet 160 mm
- 1 flat nose pliers \equiv
- 1 smooth half - round long bent needle nose pliers \bullet
- 1 combination pliers \bullet
- 1 diagonal flush cutting nippers \downarrow
- 1 diagonal cutting nippers \downarrow
- 1 screwholding screwdriver for slotted head screws \bullet 4x125 mm

Beta N.

- 73/B13
- 96N/SC9
- 991
- 992
- 998
- 1128BSX
- 1142BM
- 1166BM
- 1172BM
- 1178BM/P
- 1178BM
- 1185BM
- 1188BM
- 1250

Quantity/Description

- 1 screwholding screwdriver for cross head Phillips® screws \oplus PH0x125 mm
- 8 micro-screwdrivers
- 1 engineer's hammer 200 g
- 1 measuring tape 5 m
- 1 telescopic joint inspection mirror
- 3 needle files
- 1 spring puller
- 1 bristle brush
- 1 pen oiler
- 1 snap - off blade utility knife
- 1 self - locking tool
- 1 soldering iron 25 W
- 1 de - soldering pump
- 1 LED inspection torch

Beta N.

- 1251
- 1370
- 1257LPH /S8
- 1692
- 1715
- 1720/S3
- 1723
- 1738
- 1756
- 1771
- 1779
- 1814M
- 1830T
- 1835/2

5980EL/A

059800241

Assortment recommended in combination with 2032TV - 2032VV - 2033P/VV

Electronics



Quantity/Description

13	small double open end wrenches 4÷14 mm	73/B13
9	offset hexagon key wrenches 1,5÷10 mm	96/SC9
8	offset key wrenches for Torx® head screws T9 - T10 - T15 - T20 - T25 - T27 - T30 - T40	97TX/BG8
1	adjustable wrench 150 mm	111
18	set of 13 hexagon sockets and 5 accessories, 1/4" square drive	900/C13-5
1	straight thin knurled point spring tweezers 130 mm	990
1	bent point tweezers 130 mm	991
1	extra slim short end spring tweezers 120 mm	999A
1	electrician's scissors, straight blades	1128BMX
1	front wire stripping pliers, self - adjusting 170 mm	1149F
1	half-round needle nose pliers 180 mm	1150BM
1	flat nose pliers 140 mm	1172BM
1	smooth half - round long needle nose pliers 140 mm	1177BM
1	smooth half - round long bent needle nose pliers 140 mm	1178BM/P
1	diagonal flush cutting nippers, rounded tips 120 mm	1184BM
1	diagonal flush cutting nippers, slim tips 120 mm	1186BM
1	end flush oblique cutting nippers 120 mm	1191BM
8	micro-screwdrivers	1257LPH/S8
1	mains testing screwdriver	1253

Beta N.

Quantity/Description

1	screwdriver for slotted head screws, extra-short series 6,5x30 mm	1290N
3	screwdrivers for cross head Phillips® screws PH0x60 - PH1x80 - PH2x100 mm	1292
2	screwdriver for cross head Phillips® screws, extra-short series PH1x30 - PH2x30 mm	1292N
5	screwdrivers for headless slotted screws 2,5x60 - 3x75 - 4x100 - 5x125 - 6,5x150 mm	1294
1	engineer's hammer 200 g	1370
1	flexible graduated rule 150 mm	1682
1	engineer's scriber 220 mm	1688
1	measuring tape 5 m	1692
1	telescopic joint inspection mirror 670 mm	1715
1	needle files	1720R
1	needle files	1720T
1	needle files	1720P
1	spring puller	1723
1	bristle brush	1738
1	pen oiler	1756
1	snap - off blade utility knife	1771BM
1	fold - away knife	1777BM
1	self - locking tool	1779
1	soldering iron 25W	1814M
1	de - soldering pump	1830T
1	LED inspection torch	1835/2

Beta N.

5980ID

Assortment of 35 tools

Plumbing maintenance



11.6 kg

Quantity/Description

- 1 flat chisels 150 mm
- 1 flat chisels, ribbed type 200 mm
- 12 double open end wrenches 6x7 - 8x9 - 10x11 - 12x13 - 14x15 - 16x17 - 18x19 - 20x22 - 21x23 - 24x27 - 25x28 - 30x32 mm
- 1 adjustable wrench 250 mm
- 1 pipe cutter for copper and light alloy pipes Ø 3÷30 mm
- 1 pipe wrench Swedish pattern 320 mm
- 1 Slip joint pliers boxed joints 250 mm
- 1 self - locking pliers 240 mm
- 1 tin snips 300 mm
- 1 electrician's scissors, straight blades
- 1 half-round needle nose pliers 180 mm

Beta N.

- 34
- 35
- 55/S12X
- 111
- 334
- 374
- 1048
- 1052
- 1112
- 1128BMX
- 1150BM

Quantity/Description

- 4 screwdrivers for cross head Phillips® screws ● 3x75 - 4x100 - 5,5x150 - 8x150 mm
- 2 screwdrivers for cross head Phillips® screws ⊕ PH1x80 - PH2x100 mm
- 1 engineer's hammer 300 g
- 1 measuring tape, made of fibre 2 m
- 1 measuring tape 5 m
- 1 spirit level, made of aluminium 200 mm
- 1 second-cut half-round files 200 mm
- 1 hacksaw frame, aluminium handle
- 1 brake shoe cleaning brush plastic handle steel wires

Beta N.

- 1201
- 1202
- 1370
- 1690F
- 1692
- 1696
- 1719BMA/M
- 1725
- 1737NX

5980 ID

059800321

Assortment recommended in combination with 2009N/VV

Car repairs



28.6 kg

Quantity/Description	Beta N.	Quantity/Description	Beta N.
2 drift punches Ø 3 - 4 mm	30	1 pry bar	964
2 pin punches Ø 6 - 8 mm	31	1 Slip joint pliers boxed joints 250 mm	1048
1 centre punch Ø 4 mm	32	1 adjustable self locking pliers, curved jaws	1055
2 flat chisels, ribbed type 150 - 200 mm	35	1 heavy duty diagonal cutting nippers 160 mm	1084BM
18 combination wrenches	42	1 electrician's scissors, straight blades	1128BMX
6÷14 - 17 - 19 - 22 - 24 - 27 - 30 - 32 - 36 - 41 mm		1 half-round needle nose pliers 180 mm	1150BM
10 double ended offset ring wrenches 6x7 - 8x9 - 10x11 - 12x13 - 14x15 - 16x17 - 18x19 - 20x22 - 24x27 - 30x32 mm	90	1 extra long needle knurled nose pliers, bi-material handles 160 mm	1166BM
10 offset hexagon key wrenches 1,5÷12 mm	96N/B10	4 screwdrivers for slotted head screws with hexagon bolsters 160 mm	1260E
17 1/2" square drive hexagon sockets	920A	3 screwdrivers for cross head Phillips® screws with hexagon bolsters 160 mm	1262E
1 1/2" drive extension bar 125 mm	920/21	PH2x150 - PH3x175 - PH4x200 mm	
1 1/2" drive extension bar 255 mm	920/22	1 ball peen hammer 900 g	1377
1 1/2" drive universal joint	920/25	1 soft face hammer Ø 35 mm	1390
1 1/2" drive sliding T-handle	920/42	1 metric feeler gauge	1708/20
1 1/2" drive push-through square ratchet	920/50	1 three - cutting edges scraper 200 mm	1717B
11 3/4" square drive hexagon socket 22 - 24 - 27 - 30 - 32 - 36 - 41 - 46 - 50 - 55 - 60 mm	928A	5 second cut files 200 mm	1719BMA/S5
1 3/4" drive extension bar 200 mm	928/21	1 hacksaw frame, aluminium handle	1725
1 3/4" drive swivel handle	928/36A		
1 3/4" drive sliding T - handle	928/42		
1 3/4" drive reversible ratchet	928/55		

5902MT

059020043

Assortment recommended in combination with C22S - C23S - C23SC - C39T

5902MT/AS

Assortment of 99 tools for earth-moving machinery (CATERPILLAR)

Car repairs



27.3 kg

Quantity/Description	Beta N.	Quantity/Description	Beta N.
2 drift punches Ø 3 - 4 mm	30	1 pry bar	964
2 pin punches Ø 6 - 8 mm	31	1 Slip joint pliers boxed joints 250 mm	1048
1 centre punch Ø 4 mm	32	1 adjustable self locking pliers, curved jaws	1055
2 flat chisels, ribbed type 150 - 200 mm	35	1 heavy duty diagonal cutting nippers 160 mm	1084BM
20 combination wrenches 1/4÷1.1/2"	42AS	1 electrician's scissors, straight blades	1128BMX
6 double ended offset ring wrenches 1/4x5/16 - 3/8x7/16 - 1/2x9/16	90AS	1 half-round needle nose pliers 180 mm	1150BM
5/8x3/4 - 11/16x13/16 - 7/8x15/16"		1 extra long needle knurled nose pliers, bi-material handles 160 mm	1166BM
11 offset hexagon key wrenches Ø 3/64÷3/8"	96AS/B11	4 screwdrivers for slotted head screws with hexagon bolsters	1260E
10 1/2" square drive bi - hex sockets Ø 7/16 - 1/2 - 9/16	920AS	6,5x150 - 8x175 - 10x200 - 12x250 mm	
5/8 - 11/16 - 3/4 - 13/16 - 7/8 - 15/16 - 1"		3 screwdrivers for cross head Phillips® screws with hexagon bolsters	1262E
1 1/2" drive extension bar 125 mm	920/21	PH2x150 - PH3x175 - PH4x200 mm	
1 1/2" drive extension bar 255 mm	920/22	1 ball peen hammer 900 g	1377
1 1/2" drive universal joint	920/25	1 soft face hammer Ø 35 mm	1390
1 1/2" drive sliding T-handle	920/42	1 metric feeler gauge 150 - 200 mm	1708/20
1 1/2" drive push-through square ratchet	920/50	1 three - cutting edges scraper 200 mm	1717B
12 hexagon hand sockets 1/4" □ 3/4", 7/8 - 15/16 - 1 - 1.1/16 - 1.1/8 -	928AS	5 second cut files 200 mm	1719BMA/S5
1.1/4 - 1.5/16 1.1/2 - 1.5/8 - 1.11/16 - 1.7/8 - 2"		1 hacksaw frame, aluminium handle	1725
1 3/4" drive extension bar 200 mm	928/21		
1 3/4" drive swivel handle	928/36A		
1 3/4" drive sliding T - handle	928/42		
1 3/4" drive reversible ratchet	928/55		

5902MT/AS

059020044

Assortment recommended in combination with C22S - C23S - C23SC - C39T

5904VG/1M

assortment of 76 tools

Car repair



Quantity/Description

16	combination wrenches 6+21 mm
5	combination wrenches 22 - 24 - 27 - 30 - 32 mm
1	heavy duty diagonal cutting nippers 160 mm
1	half-round needle nose pliers 180 mm
1	screwdrivers for slotted head screws 160 mm
8	offset hexagon key wrenches 2-2,5-3-4-5-6-7-8 mm
6	drivers for Torx® head screws, with handles T10-T15-T20-T25-T27-T30
4	screwdrivers for cross head Phillips® screws 3x75 - 4x100 - 5,5x150 - 6,5x150 mm
3	screwdrivers for cross head Phillips® screws PH0x60 - PH1x80 - PH2x100 mm
1	1/2" wobble extension bar 125 mm
1	1/2" wobble extension bar 250 mm

Beta N.	TR
42	M15
42	M16
1084	M132
1150	M132
1166	M132
96T	M50
97TTX	M55
1201	M220
1202	M220
920AN/125	M83
920AN/250	M83

Quantity/Description

1	1/2" drive universal joint
1	1/2" drive sliding T-handle
1	1/2" drive reversible ratchet
19	1/2" square drive hexagon sockets 10+24 - 26 - 27 - 30 - 32 mm
1	circlip pliers straight, internal 180 mm
1	circlip pliers bent, internal 170 mm
1	circlip pliers straight, external 175 mm
1	circlip pliers bent, external 175 mm
2	flat chisels, ribbed type 100 - 200 mm
1	engineer's hammer 300 g
1	soft face hammer Ø 35 mm

Beta N.	TR
920/25	M83
920/42	M83
920/55	M83
920A	M83
1032	M145
1034	M145
1036	M145
1038	M145
35	M234
1370	M234
1390	M234

5904 VG/1M

059040197

Assortment recommended in combination with C24S - C24SA - C33 - C39 with 5 - 6 - 7 - 8 drawers
C23ST - C39T - C24SL - C24SL/CAB - C59 - C55

5904VG/2M

assortment of 170 tools

Car repair



M15 M16 VP/M3



M50 M55 M86



M208 M85 M234



M83 M131 M145

Quantity/Description

- 16 combination wrenches 6÷21 mm
- 5 combination wrenches 22 - 24 - 27 - 30 - 32 mm
- 8 offset hexagon key wrenches Ø 2-2,5-3-4-5-6-7-8 mm
- 6 drivers for Torx® head screws, with handles
 - ⊕ T10-T15-T20-T25-T27-T30
- 7 hexagon bits Ø 4-5-6-7-8-10-12 mm
- 7 hexagon bits Ø 4-5-6-7-8-10-12 mm
- 5 bits with XZN® profile Ø 5-6-8-10-12 mm
- 5 bits with XZN® profile Ø 5-6-8-10-12 mm
- 7 bits for Torx® head screws ⊕ T20-T25-T30-T40-T45-T50-T55
- 6 bits for Torx® head screws ⊕ T25-T30-T40-T45-T50-T55
- 7 bits for Tamper Resistant Torx® head screws ⊕ T20-T25-T30-T40-T45-T50-T55
- 1 bit holder sockets for item 867
- 1 bit holder sockets for item 867
- 5 screwdrivers for cross head Phillips® screws
 - 3x75 - 4x100 - 4x125 - 5,5x150 - 6,5x150 mm
- 3 screwdrivers for cross head Phillips® screws
 - ⊕ PH0x60 - PH1x80 - PH2x100 mm
- 1 screwdrivers for slotted head screws, extra-short series ● 4x30 mm
- 1 screwdrivers for cross head Phillips® screws, extra - short series ⊕ PH1x30 mm
- 5 bits for slotted head screws, coloured ● 0,5x3 - 0,6x4,5 - 0,8x5,5 - 1x5,5 - 1,2x6,5 mm
- 8 hexagon bits for power drivers, coloured Ø 2 - 2,5 - 3 - 4 - 5 - 6 - 8 - 10 mm
- 5 bits for cross head Phillips® screws, coloured
 - ⊕ PH0 - PH1 - PH2 - PH3 - PH4

Beta N.	TR
42	M15
42	M16
96T	M50
97TTX	M55
867PE	M86
867PE/L	M86
867XZN	M86
867XZN/L	M86
867TX	M86
867TX/L	M86
867RTX	M86
867/1	M86
867/2	M86
1260	M208
1262	M208
1260N	M208
1262N	M208
860LP	M85
860PE	M85
860PH	M85

Quantity/Description

- 4 bits for cross head Pozidriv® - Supadriv® screws, coloured ⊕ PZ1 - PZ2 - PZ3 - PZ4
- 10 bits for Torx® head screws, coloured ⊕ T7-T8-T9-T10-T15-T20-T25-T27-T30-T40
- 8 bits for Tamper Resistant Torx® head screws, coloured ⊕ T9-T10-T15-T20-T25-T27-T30-T40
- 1 magnetic bit holder with handle 230 mm
- 1 reversible bit ratchet 100 mm
- 2 flat chisels, ribbed type 100 - 200 mm
- 1 engineer's hammer 300 g
- 1 soft face hammer Ø 35 mm
- 1 1/2" wobble extension bar 125 mm
- 1 1/2" wobble extension bar 250 mm
- 1 1/2" drive universal joint
- 1 1/2" drive sliding T-handle
- 1 1/2" drive reversible ratchet ⊕
- 19 1/2" square drive hexagon sockets Ø 10÷24 - 26 - 27 - 30 - 32 mm
- 1 half-round needle nose pliers = 180 mm
- 1 extra long needle knurled nose pliers, bi-material handles ● 160 mm
- 1 heavy duty diagonal cutting nippers ≡ 160 mm
- 1 circlip pliers straight, internal ⊕ 180 mm
- 1 circlip pliers bent, internal ⊕ 170 mm
- 1 circlip pliers straight, external ● 175 mm
- 1 circlip pliers bent, external ● 175 mm
- 1 soft thermoformed tray

Beta N.	TR
860PZ	M85
860TX	M85
860RTX	M85
851SR	M85
860/55	M85
35	M234
1370	M234
1390	M234
920AN/125	M83
920AN/250	M83
920/25	M83
920/42	M83
920/55	M83
920A	M83
1150BM	M131
1166BM	M131
1084BM	M131
1032	M145
1034	M145
1036	M145
1038	M145
	VPM3

5904VG/2M

059040198

Assortment recommended in combination with C24S - C24SA - C33 - C39 with 6 - 7 - 8 drawers
C24SL - C24SL/CAB - C59 - C55

Car repairs



14.5 kg

Quantity/Description

16	combination wrenches 6÷21 mm
5	combination wrenches 22 - 24 - 27 - 30 - 32 mm
19	1/2" square drive hexagon sockets
	○ 10÷24 - 26 - 27 - 30 - 32 mm
5	1/2" drive, socket drivers for hexagon screws
	○ 5 - 6 - 8 - 10 - 12 mm
1	1/2" drive extension bar 125 mm
1	1/2" drive extension bar 255 mm
1	1/2" drive universal joint
1	1/2" drive sliding T-handle
1	1/2" drive reversible ratchet
1	Slip joint pliers boxed joints 250 mm
1	self - locking pliers 240 mm
1	heavy duty diagonal cutting nippers 160 mm
1	screwdrivers for slotted head screws 160 mm
1	half-round needle nose pliers 180 mm
1	circlip pliers straight, internal 180 mm
1	circlip pliers straight, external 175 mm

Beta N. TR

42	T15
42	T16
920A	T80
920ME	T80
920/21	T80
920/22	T80
920/25	T80
920/42	T80
920/55	T80
1048	T153
1052	T153
1084	T132
1166	T132
1150	T132
1032	T145
1036	T145

Quantity/Description

1	circlip pliers bent, internal 170 mm
1	circlip pliers bent, external 175 mm
2	flat chisels, ribbed type 100 - 200 mm
1	engineer's hammer 300 g
1	soft face hammer Ø 35 mm
4	screwdrivers for cross head Phillips® screws 3x75 - 4x100 - 5,5x150 - 6,5x150 mm
3	screwdrivers for cross head Phillips® screws PH0x60 - PH1x80 - PH2x100 mm
8	double open end wrenches 6x7 - 8x9 - 10x11 - 12x13 - 14x15 - 16x17 - 18x19 - 20x22 mm
9	offset hexagon key wrenches
	○ 1,5 - 2 - 2,5 - 3 - 4 - 5 - 6 - 8 - 10 mm
6	offset hexagon key wrenches
	○ 2 - 2,5 - 3 - 4 - 5 - 6 mm
6	drivers for Torx® head screws, with handles
	○ T10 - T15 - T20 - T25 - T27 - T30

Beta N. TR

1034	T145
1038	T145
35	T234
1370	T234
1390	T234
1260	T208
1262	T208
55	T33
96/SC9	T33
96T	T52
97TTX	T55

5904VG/3

Assortment of 132 tools

Car repairs



20.7 kg

Quantity/Description

6	pin punches Ø 2÷8 mm
1	centre punch Ø 5 mm
1	flat chisels, ribbed type 200 mm
17	combination wrenches 6÷22 mm
8	double open end wrenches 6x7 - 8x9 - 10x11 - 12x13 - 14x15 - 16x17 - 18x19 - 20x22 mm
9	offset hexagon key wrenches Ø 1,5 - 2 - 2,5 - 3 - 4 - 5 - 6 - 8 - 10 mm
11	offset hexagon key wrenches Ø 2÷10 mm
13	offset key wrenches for Torx® head screws Ⓢ T6÷T50
1	adjustable wrench 300 mm
13	1/2" square drive hexagon sockets with rail Ø 10÷22 mm
1	1/2" drive extension bar 125 mm
1	1/2" drive extension bar 255 mm
1	1/2" drive universal joint
1	1/2" drive sliding T-handle
1	1/2" drive push-through square ratchet Ⓢ
6	T - handle wrenches with swivelling socket Ø 8 - 10 - 12 - 13 - 17 - 19 mm
1	pry bar with handle 450 mm
2	circlip pliers straight, internal Ø 180 - 225 mm
2	circlip pliers bent, internal Ø 170 - 210 mm
2	circlip pliers straight, external ● 175 - 225 mm
2	circlip pliers bent, external ● 175 - 220 mm
1	Slip joint pliers boxed joints 250 mm
1	self - locking pliers 240 mm
1	heavy duty diagonal cutting nippers ⚡ 200 mm
1	toggle lever assisted end cutting nippers ⚡ 200 mm

Beta N.

31/B6
32
35
42
55
96N/SC9
96T/SP11
97TX/B13
111
920A/SB13
920/21
920/22
920/25
920/42
920/50
952
965
1032
1034
1036
1038
1048
1057A
1084BM
1092V

Quantity/Description

1	tin snips 250 mm
1	electrician's scissors, straight blades
1	half-round needle nose pliers = 180 mm
4	screwdrivers for cross head Phillips® screws ● 3x75 - 4x100 - 5,5x125 - 6,5x150 mm
1	screwdrivers for slotted head screws, extra-short series ● 6,5x30 mm
2	screwdrivers for slotted head screws with hexagon bolsters ● 8x175 - 10x200 mm
3	screwdrivers for cross head Phillips® screws Ⓢ PH0x100 - PH1x120 - PH2x100 mm
1	screwdrivers for cross head Phillips® screws, extra - short series Ⓢ PH2x30 mm
1	screwdrivers for cross head Phillips® screws with hexagon bolsters Ⓢ PH3x175mm
1	screwdriver for cross head Phillips® screws, long series Ⓢ PH2x400 mm
1	screwdriver for headless slotted screws, long series ● 6,5x400 mm
1	engineer's hammer 500 g
1	soft face hammer Ø 45 mm
1	adjustable oil filter wrench
1	metric feeler gauge
5	files 200 mm
1	hacksaw frame, aluminium handle
1	metal oil can 200 cc

Beta N.

1112
1128BMX
1150BM
1260
1260N
1260E
1262
1262N
1262E
1262L
1264L
1370
1390
1491
1708/20
1719BMA/S5
1726BM
1751

5904 VG/3

059040192

Assortment recommended in combination with C24S - C24SA - C33 - C39 with 7 - 8 drawers
C24SL - C24SL/CAB - C59 - C55

Car repair



T199 T202 T83



T145 T153 T131 T234



T52 T33 T15 T16



T63 VP5

Quantity/Description

- 21 combination wrenches 6-7-8-9-10-11-12-13-14-15-16-17-18-19-20-21-22-24-27-30-32 mm
- 8 double open end wrenches 6x7-8x9-10x11-12x13-14x15-16x17-18x19-20x22 mm
- 9 offset hexagon key wrenches \varnothing 1,5÷10 mm
- 6 offset hexagon key wrenches \varnothing 2-2,5-3-4-5-6 mm
- 8 T - handle wrenches with swivelling socket \varnothing 7-8-10-12-13-14-17-19 mm
- 19 1/2" square drive hexagon sockets \varnothing 10-11-12-13-14-15-16-17-18-19-20-21-22-23-24-26-27-30-32 mm
- 1 1/2" drive extension bar 125 mm
- 1 1/2" drive extension bar 255 mm
- 1 1/2" drive universal joint
- 1 1/2" drive sliding T-handle 305 mm
- 1 1/2" drive reversible ratchet \otimes
- 1 heavy duty diagonal cutting nippers \nless 160 mm
- 1 half-round needle nose pliers \equiv 180 mm
- 1 extra long needle knurled nose pliers, bi-material handles \bullet 160 mm
- 1 circlip pliers straight, internal \odot 180 mm

Beta N.	TR
42	T15-T16
55	T33
96/SC9	T33
96T	T52
952	T63
920A	T83
920/21	T83
920/22	T83
920/25	T83
920/42	T83
920/55	T83
1084BM	T131
1150BM	T131
1166BM	T131
1032	T145

Quantity/Description

- 1 circlip pliers bent, internal \odot 170 mm
- 1 circlip pliers straight, external \bullet 175 mm
- 1 circlip pliers bent, external \bullet 175 mm
- 1 self - locking pliers 240 mm
- 1 Slip joint pliers boxed joints 250 mm
- 7 screwdrivers for cross head Phillips® screws \bullet 2,5x50 - 3x75 - 3,5x100 - 4x125 - 5,5x100 - 5,5x150 - 6,5x150 mm
- 6 screwdrivers for cross head Phillips® screws \oplus PH0x60 - PH0x100 - PH1x80 - PH1x120 - PH2x100 - PH2x150 mm
- 2 flat chisels, ribbed type 100-200 mm
- 1 engineer's hammer 300 g
- 1 soft face hammer \varnothing 35 mm
- empty thermoformed tray

Beta N.	TR
1034	T145
1036	T145
1038	T145
1052	T153
1048	T153
1260	T199
1262	T202
35	T234
1370	T234
1390	T234
VP5	

5904VG/5T

Assortment of 153 tools

Car repairs

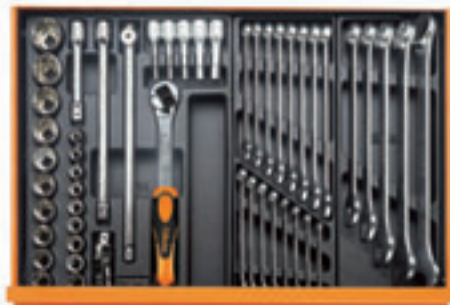

T80 T15 T16



T63 VP6



T145 T170 T176 T52



T33 T171 T172 T173



T234 T131 T112 T153

25 kg

Quantity/Description

- 5 1/2" drive, socket drivers for hexagon screws \odot 5 - 6 - 8 - 10 - 12 mm
- 1 1/2" drive extension bar 125 mm
- 1 1/2" drive extension bar 255 mm
- 1 1/2" drive universal joint
- 1 1/2" drive sliding T-handle
- 1 1/2" drive reversible ratchet \oplus
- 19 1/2" square drive hexagon sockets \odot 10÷24 - 26 - 27 - 30 - 32 mm
- 16 combination wrenches 6÷21 mm
- 5 combination wrenches 22 - 24 - 27 - 30 - 32 mm
- 8 T - handle wrenches with swivelling socket \odot 7 - 8 - 10 - 12 - 13 - 14 - 17 - 19 mm
- empty thermoformed tray
- 1 circlip pliers straight, internal \odot 180 mm
- 1 circlip pliers bent, internal \odot 170 mm
- 1 circlip pliers straight, external \bullet 175 mm
- 1 circlip pliers bent, external \bullet 175 mm
- 7 screwdrivers for cross head Phillips® screws \bullet 2,5x50 - 3x75 - 3,5x100 - 4x125 - 5,5x100 - 5,5x150 - 6,5x150 mm
- 5 drivers for Torx® head screws, with handles \odot T25 - T27 - T30 - T40 - T45
- 6 offset hexagon key wrenches \odot 2 - 2,5 - 3 - 4 - 5 - 6 mm
- 8 double open end wrenches 6x7 - 8x9 - 10x11 - 12x13 - 14x15 - 16x17 - 18x19 - 20x22 mm
- 9 offset hexagon key wrenches \odot 1,5 - 2 - 2,5 - 3 - 4 - 5 - 6 - 8 - 10 mm

Beta N.	TR
920ME	T80
920/21	T80
920/22	T80
920/25	T80
920/42	T80
920/55	T80
920A	T80
42	T15
42	T16
952	T63
VP6	VP6
1032	T145
1034	T145
1036	T145
1038	T145
1290	T170
1297TX	T176
96T	T52
55	T33
96N/SC9	T33

Quantity/Description

- 3 screwdrivers for cross head Phillips® screws \bullet 8x150 - 8x200 - 10x200 mm
- 2 screwdriver for slotted head screws, extra-short series \bullet 4x30 - 6,5x30 mm
- 6 screwdrivers for cross head Phillips® screws \oplus PH0x60 - PH0x100 - PH1x80 - PH1x120 - PH2x100 - PH2x150 mm
- 2 screwdrivers for cross head Phillips® screws \oplus PH3x150 - PH4x200 mm
- 2 screwdriver for cross head Phillips® screws, extra-short series \oplus PH1x30 - PH2x30 mm
- 2 flat chisels, ribbed type 100 - 200 mm
- 1 engineer's hammer 300 g
- 1 soft face hammer \varnothing 35 mm
- 1 half-round needle nose pliers \equiv 180 mm
- 1 extra long needle knurled nose pliers, bi-material handles \bullet 160 mm
- 1 heavy duty diagonal cutting nippers ∇ 160 mm
- 8 bits for Torx® head screws \odot T6÷T15
- 8 bits for Torx® head screws \odot T20÷T55
- 1 socket holder
- 1 socket holder
- 1 1/4" sockets for Torx® head screws \odot E4÷E10
- 1 1/2" sockets for Torx® head screws \odot E12÷E24
- 1 1/2" drive, socket drivers for Torx® head screws \odot T55L - T60 - T70L
- 1 Slip joint pliers boxed joints 250 mm
- 1 self - locking pliers 240 mm

Beta N.	TR
1290	T171
1290N	T171
1292	T172
1292	T173
1292N	T173
35	T234
1370	T234
1390	T234
1150BM	T131
1166BM	T131
1084BM	T131
861TX	T112
866TX	T112
895/1	T112
895/6	T112
900FTX	T112
920FTX	T112
920TX	T112
1048	T153
1052	T153

5904 VG/5T

059040196

Assortment recommended in combination with C24S - C24SA - C33 - C39 with 7 - 8 drawers C24SL - C24SL/CAB - C59 - C55

Car repairs



20 kg

Quantity/Description

- 1 drift punches Ø 4 mm
- 6 pin punches Ø 2 - 3 - 4 - 5 - 6 - 8 mm
- 1 centre punch Ø 4 mm
- 1 flat chisels 150 mm
- 1 cape chisels, standard type 150 mm
- 17 combination wrenches 6÷22 mm
- 10 offset hexagon key wrenches 1,5÷12 mm
- 1 adjustable wrench 300 mm
- 12 hi-torque hexagon nut spinners, long series 4÷14 mm
- 1 pry bar with handle 450 mm
- 1 Slip joint pliers boxed joints 250 mm
- 1 self - locking pliers 240 mm
- 1 adjustable self locking pliers, aluminium jaws 280 mm
- 1 heavy duty diagonal cutting nippers 160 mm
- 1 construction worker's pincers 250 mm
- 1 compound leverage shears, straight blades
- 1 electrician's scissors, straight blades
- 1 half-round needle nose pliers 180 mm
- 1 screwdriver for Dzus® head screws
- 4 screwdrivers for cross head Phillips® screws
 - 3x75 - 4x100 - 5,5x150 - 6,5x150 mm
- 1 screwdrivers for slotted head screws, extra-short series ● 4x30 mm
- 2 screwdrivers for slotted head screws with hexagon bolsters ● 10x175 - 12x200 mm

Beta N.

- 30
- 31/B6
- 32
- 34
- 36
- 42/S17
- 96/B10
- 111N
- 943BX
- 965
- 1048
- 1052
- 1060AL
- 1084BM
- 1098PL
- 1122
- 1128BMX
- 1150BM
- 1201DZ
- 1260
- 1260N
- 1260E

Quantity/Description

- 3 screwdrivers for cross head Phillips® screws ⚡ PH0x60 - PH1x80 - PH2x100 mm
- 1 screwdrivers for cross head Phillips® screws, extra - short series ⚡ PH1x30 mm
- 1 screwdrivers for cross head Phillips® screws with hexagon bolsters ⚡ PH3x175 mm
- 7 drivers for Torx® head screws ⚡ T6 - T8 - T10 - T15 - T20 - T25 - T30
- 1 curved dolly 1350 g
- 1 toe dolly
- 1 heel dolly
- 1 general purpose dolly
- 1 buffer dolly
- 1 curved angle spoon
- 1 heavy duty spoon
- 1 long double-ended spoon
- 1 body blade holder, with blade 9"
- 1 extra flat chisel with hand guard
- 1 body hammer
- 1 body hammer Ø 32 mm
- 1 engineer's hammer 300 g
- 1 soft face hammer Ø 35 mm
- 1 measuring tape 5 m

Beta N.

- 1262
- 1262N
- 1262E
- 1267TX
- 1303
- 1305
- 1306
- 1310
- 1313
- 1326
- 1327
- 1330
- 1338A
- 1342PM
- 1345
- 1357Z/32
- 1370
- 1390
- 1692

5905VG/1

059050158

Assortment recommended in combination with C25

5905VG/2

Assortment of 118 tools

Car repairs



19.5 kg

Quantity/Description

- 6 2 drift punches, 1 centre punch, 3 flat chisels with metal holder
- 14 combination wrenches 6+14 - 17 - 19 - 22 - 24 mm
- 13 double open end wrenches 6x7 - 8x9 - 10x11 - 12x13 - 14x15 - 16x17 - 18x19 - 20x22 - 21x23 - 24x26 - 25x28 - 27x29 - 30x32 mm
- 3 half - moon ring wrenches 11x13 - 14x17 - 19x22 mm
- 10 offset hexagon key wrenches \odot 1,5+12 mm
- 6 drivers for Torx® head screws, with handles \odot T10 - T15 - T20 - T25 - T30 - T40
- 2 1/2" drive impact sockets \odot 17 - 19 mm
- 20 1/2" square drive hexagon sockets \odot 10+24 - 26 - 27 - 28 - 30 - 32 mm
- 1 1/2" drive extension bar 125 mm
- 1 1/2" drive extension bar 255 mm
- 1 1/2" drive universal joint
- 1 1/2" drive sliding T-handle
- 1 1/2" drive reversible ratchet \oplus
- 8 T - handle wrenches with swivelling socket \odot 7 - 8 - 10 - 11 - 13 - 14 - 17 - 19 mm
- 1 T - handle swivel spark plug wrenches
- 1 wheel nut wrench \odot 17x19x22x \blacksquare 1/2"
- 1 circlip pliers straight, internal \odot 180 mm
- 1 circlip pliers bent, internal \odot 170 mm
- 1 circlip pliers straight, external \bullet 175 mm

Beta N.

- 38/B6
- 42
- 55
- 83
- 96N/B10
- 97TTX
- 720
- 920A
- 920/21
- 920/22
- 920/25
- 920/42
- 920/55
- 952
- 959
- 979
- 1032
- 1034
- 1036

Quantity/Description

- 1 circlip pliers bent, external \bullet 175 mm
- 1 Slip joint pliers boxed joints 250 mm
- 1 self - locking pliers 240 mm
- 1 heavy duty diagonal cutting nippers \llcorner 160 mm
- 1 compound leverage shears, straight blades 250 mm
- 1 electrician's scissors, straight blades
- 1 half-round needle nose pliers \equiv 180 mm
- 1 extra long needle knurled nose pliers, bi-material handles \bullet 160 mm
- 8 screwdrivers for cross head Phillips® screws \bullet 2,5x50 - 3x75 - 3,5x100 - 4x125 - 5,5x125 - 6,5x150 - 8x200 - 10x200 mm
- 2 screwdrivers for slotted head screws with hexagon bolsters \bullet 10x200 - 12x250 mm
- 1 screwdrivers for slotted head screws, extra-short series \bullet 6,5x30 mm
- 4 screwdrivers for cross head Phillips® screws \oplus PH0x60 - PH1x80 - PH2x100 - PH3x150 mm
- 1 engineer's hammer 400 g
- 1 soft face hammer \varnothing 35 mm
- 1 adjustable oil filter wrench
- 1 circuit tester 3+48 V

Beta N.

- 1038
- 1048
- 1052
- 1084BM
- 1122
- 1128BMX
- 1150BM
- 1166BM
- 1260
- 1260E
- 1260N
- 1262
- 1370
- 1390
- 1491
- 1498

5905 VG/2

059050144

Assortment recommended in combination with C25

Car repair



Quantity/Description

Beta N. TR

Quantity/Description

Beta N. TR

16	combination wrenches 6+21 mm	42	T15
5	combination wrenches 22 - 24 - 27 - 30 - 32 mm	42	T16
5	pin punches Ø 2 - 3 - 4 - 5 - 6 mm	31	T31
1	centre punch Ø 4 mm	32	T31
12	double open end wrenches 6x7 - 8x9 - 10x11 - 12x13 - 14x15 - 16x17 18x19 - 20x22 - 21x23 - 24x26 - 27x29 - 30x32 mm	55	T31
9	offset hexagon key wrenches Ø 1,5 - 2 - 2,5 - 3 - 4 - 5 - 6 - 8 - 10 mm	96N/SC9	T31
5	1/2" drive, socket drivers for hexagon screws Ø 5 - 6 - 8 - 10 - 12 mm	920ME	T80
1	1/2" drive extension bar 125 mm	920/21	T80
1	1/2" drive extension bar 255 mm	920/22	T80
1	1/2" drive universal joint	920/25	T80
1	1/2" drive sliding T-handle	920/42	T80
1	1/2" drive reversible ratchet	920/55	T80
19	1/2" square drive hexagon sockets Ø 10-24 - 26 - 27 - 30 - 32 mm	920A	T80
1	circlip pliers straight, internal Ø 180 mm	1032	T145
1	circlip pliers bent, internal Ø 170 mm	1034	T145
1	circlip pliers straight, external Ø 175 mm	1036	T145
1	circlip pliers bent, external Ø 175 mm	1038	T145
1	circlip pliers straight, internal Ø 140 mm	1032	T146
1	circlip pliers bent, internal Ø 225 mm	1034	T146
1	circlip pliers straight, external Ø 140 mm	1036	T146
1	circlip pliers bent, external Ø 225 mm	1038	T146
9	screwdrivers for cross head Phillips® screws ● 3x75 - 3,5x100 - 4x100 - 4x150 - 5,5x100 - 5,5x150 - 6,5x150 - 8x150 - 10x200 mm	1260N	T167
2	screwdrivers for slotted head screws, extra-short series ● 4x30 - 6,5x30 mm	1260N	T167
7	screwdrivers for cross head Phillips® screws ● PH0x60 - PH0x100 - PH1x80 - PH1x120 - PH2x100 - PH2x150 - PH3x150 mm	1262	T168
2	screwdrivers for cross head Phillips® screws, extra - short series ● PH1x30 - PH2x30 mm	1262N	T168
8	T - handle wrenches with swivelling socket Ø 7 - 8 - 10 - 12 - 13 - 14 - 17 - 19 mm	952	T63
2	screwdriver for cross head Phillips® screws, long series ● PH1x400 - PH2x400 mm	1262L	T209
3	screwdriver for headless slotted screws, long series ● 3x300 - 4x400 - 5x400 mm	1264L	T209
6	drivers for Torx® head screws, with handles ● T10-T15-T20- T25-T27-T30	97TTX	T55
14	1/2" drive impact sockets Ø 10-11-12-13-14-15-16-17-18-19- 21-22-23-24 mm	720	T110

1	1/2" drive impact extension bar 125 mm	720/21	T110
5	socket drivers for hexagon screws Ø 5L - 6L - 7L - 8L - 10L	920PE	T113
4	1/2" drive, socket drivers for Torx® head screws ● T40L - T45L - T55L - T70L	920TX	T113
3	socket drivers with XZN® profile Ø M6L - M8L - M12L	920XZN	T113
5	second cut files 200 mm	1719BMA8/S5	T236
1	adjustable oil filter wrench 110 mm	1491	T264
1	square oil drain plug socket ■ 10 mm	1494	T264
7	male hexagon oil drain plug sockets Ø 8-9-10-11-12-14-17 mm	1494E	T264
4	male square oil drain plug sockets Ø 8-9,5-12-13 mm	1494Q	T264
1	male triangular oil drain plug socket Δ	1494T	T264
1	male oil drain plug socket with XZN® profile Ø	1494XZN	T264
1	oil plug wrenches	1496/C	T264
2	flat chisels, ribbed type 100 - 200 mm	35	T234
1	engineer's hammer 300 g	1370	T234
1	soft face hammer Ø 35 mm	1390	T234
1	Slip joint pliers boxed joints 250 mm	1048	T153
1	self - locking pliers 240 mm	1052	T153
1	half-round needle nose pliers ■ 180 mm	1150	T132
1	screwdrivers for slotted head screws ● 160 mm	1166	T132
1	heavy duty diagonal cutting nippers ⊥ 160 mm	1084	T132
11	3/4" square drive hexagon socket Ø 22-24-27-30-32-34-36- 38-41-46-50 mm	928A	T105
1	3/4" drive extension bar 200 mm	928/21	T106
1	3/4" drive extension bar 380 mm	928/22	T106
1	3/4" drive sliding T - handle 450 mm	928/42	T106
1	3/4" drive reversible ratchet	928/55	T106
1	empty thermoformed tray	VP6	VP6
4	offset hexagon key wrenches Ø 13-14-17-19 mm	96N	
1	adjustable wrench 300 mm	111	
1	pry bar with handle	965	
1	tin snips 250 mm	1112	
1	electrician's scissors, straight blades	1128BMX	
1	engineer's hammer 1000 g	1370	
1	metric feeler gauge	1708/20	
1	telescopic magnet with flexible head	1712	
1	telescopic joint inspection mirror	1715	
1	three - cutting edges scraper 200 mm	1717B	
1	hacksaw frame, aluminium handle 440 mm	1726	
1	brush, brass wires	1737	
1	metal oil can 200 cl	1751	
1	snap - off blade utility knife	1771	

5910VG/3T

assortment of 202 tools

Car repair



Quantity/Description

16	combination wrenches 6÷21 mm
5	combination wrenches 22 - 24 - 27 - 30 - 32 mm
6	double swivel end socket wrenches 8x9 - 10x11 - 12x13 - 14x15 - 16x17 - 18x19 mm
1	adjustable oil filter wrench 110 mm
1	square oil drain plug socket 10 mm
7	male hexagon oil drain plug sockets 8-9-10-11-12-14-17 mm
4	male square oil drain plug sockets 8-9-5-12-13 mm
1	male triangular oil drain plug socket Δ
1	male oil drain plug socket with XZN® profile ○
1	oil plug wrenches
5	1/2" drive, socket drivers for hexagon screws ○ 5 - 6 - 8 - 10 - 12 mm
1	1/2" drive extension bar 125 mm
1	1/2" drive extension bar 255 mm
1	1/2" drive universal joint
1	1/2" drive sliding T-handle
1	1/2" drive reversible ratchet Ⓞ
19	1/2" square drive hexagon sockets ○ 10÷24 - 26 - 27 - 30 - 32 mm
1	circlip pliers straight, internal ○ 180 mm
1	circlip pliers bent, internal ○ 170 mm
1	circlip pliers straight, external ● 175 mm
1	circlip pliers bent, external ● 175 mm
1	circlip pliers straight, internal ○ 140 mm
1	circlip pliers bent, internal ○ 225 mm
1	circlip pliers straight, external ● 140 mm
1	circlip pliers bent, external ● 225 mm
6	drivers for Torx® head screws, with handles ○ T10-T15-T20-T25-T27-T30
12	swivel end ratcheting combination wrenches 8 - 9 - 10 - 11 - 12 - 13 - 14 - 15 - 16 - 17 - 18 - 19 mm
1	half-round needle nose pliers 180 mm

Beta N. Quantity/Description

42	1	extra long needle knurled nose pliers, bi-material handles ● 160 mm	1166BM
42	1	heavy duty diagonal cutting nippers 160 mm	1084BM
80	1	slip joint pliers, push button alignment 240 mm	1047
1	1	self - locking pliers 240 mm	1057A
8	8	T - handle wrenches with swivelling socket ○ 7 - 8 - 10 - 12 - 13 - 14 - 17 - 19 mm	952
9	9	screwdrivers for cross head Phillips® screws ● 3x75 - 3,5x100 - 4x100 - 4x150 - 5,5x100 - 5,5x150 - 6,5x150 - 8x150 - 10x200 mm	1260
2	2	screwdrivers for slotted head screws, extra-short series ● 4x30 - 6,5x30 mm	1260N
1	1	pin punches	31/B6
7	7	screwdrivers for cross head Phillips® screws ● PH0x60 - PH0x100 - PH1x80 - PH1x120 - PH2x100 - PH2x150 - PH3x150 mm	1262
2	2	screwdrivers for cross head Phillips® screws, extra - short series ● PH1x30 - PH2x30 mm	1262N
1	1	adjustable wrench 250 mm	111
1	1	1/2" drive swivel T-handle	920/40
6	6	T-handle wrenches with hexagon male ends ○ 2,5-3-4-5-6-8 mm	951
4	4	T handle wrenches with swivelling hexagon male ends ○ 4-5-6-8 mm	953
2	2	engineer's hammer 300-500 g	1370
2	2	screwdriver for cross head Phillips® screws, long series ● PH1x400 - PH2x400 mm	1262L
3	3	screwdriver for headless slotted screws, long series ● 3x300 - 4x400 - 5x400 mm	1264L
1	1	ball head offset hexagon key wrenches ○	96BPC/SC9
1	1	click type torque wrench 8 ÷ 60 Nm	606/6
1	1	click type torque wrench 60 ÷ 330 Nm	606/30
1	1	impact sockets	720/C12
1	1	adaptor, 1/2" female and 3/8" male drives	910/16
1	1	assortment of 12 sockets and 5 accessories 3/4"	928A/C12
1	1	lever with articulated, flat, curved head	966/C3
1	1	dead blow hammer Ø 50 mm	1392
1	1	Reversible impact wrench, made from composite material Ⓞ	1927P

5910 VG/3T

059100067

Assortment recommended in combination with C30S

Car repair



MB11



MB36



MB46

Quantity/Description

- 21 combination wrenches 6-7-8-9-10-11-12-13-14-15-16-17-18-19-20-21-22-24-27-30-32 mm
- 8 double open end wrenches 6x7-8x9-10x11-12x13-14x15-16x17-18x19-20x22 mm
- 1 Slip joint pliers boxed joints 250 mm
- 18 1/2" square drive hexagon sockets 10-11-12-13-14-15-16-17-18-19-20-21-22-24-26-27-30-32 mm
- 1 1/2" wobble extension bar 125 mm
- 1 1/2" wobble extension bar 250 mm
- 1 1/2" drive universal joint
- 1 1/2" drive sliding T-handle
- 1 1/2" drive reversible ratchet
- 5 socket drivers for hexagon screws 5-6-8-10-12 mm
- 1 circlip pliers straight, internal 180 mm
- 1 circlip pliers bent, internal 170 mm
- 1 circlip pliers straight, external 175 mm
- 1 circlip pliers bent, external 175 mm

- | | |
|-----------|------|
| Beta N. | TR |
| 42 | MB11 |
| 55 | MB11 |
| 1048 | MB11 |
| 920A | MB36 |
| 920AN/125 | MB36 |
| 920AN/250 | MB36 |
| 920/25 | MB36 |
| 920/42 | MB36 |
| 920/55 | MB36 |
| 920PE | MB36 |
| 1032 | MB36 |
| 1034 | MB36 |
| 1036 | MB36 |
| 1038 | MB36 |

Quantity/Description

- 1 flat chisels, ribbed type 200 mm
- 1 heavy duty diagonal cutting nippers 160 mm
- 1 half-round needle nose pliers 180 mm
- 1 extra long needle knurled nose pliers, bi-material handles 160 mm
- 1 engineer's hammer 500 g
- 1 soft face hammer 35 mm
- 4 screwdrivers for cross head Phillips® screws 3x75-4x100-5x125-6,5x150 mm
- 3 screwdrivers for cross head Phillips® screws PH0x60-PH1x80--PH2x100 mm
- 6 drivers for Torx® head screws T8-T10-T15-T20-T25-T30
- 9 ball head offset hexagon key wrenches
- 6 offset hexagon key wrenches 2-2,5-3-4-5-6
- 1 self - locking pliers 240 mm

- | | |
|-----------|------|
| Beta N. | TR |
| 35 | MB36 |
| 1084BM | MB36 |
| 1150BM | MB36 |
| 1166BM | MB36 |
| 1370 | MB36 |
| 1390 | MB36 |
| 1260 | MB46 |
| 1262 | MB46 |
| 1267TX | MB46 |
| 96BPC/SC9 | MB46 |
| 96T | MB46 |
| 1052 | MB46 |

5940SBK

assortment of 125 tools

Motorcycle repairs



Quantity/Description

- 1 drift punches Ø 2 mm
- 1 centre punch Ø 4 mm
- 1 flat chisels 125 mm
- 10 combination wrenches 6 - 7 - 8 - 10 - 11 - 12 - 13 - 14 - 17 - 19 mm
- 6 double open end wrenches
6x7 - 8x9 - 10x11 - 12x13 - 14x15 - 16x17 mm
- 9 offset hexagon key wrenches \odot 1,5 - 2 - 2,5 - 3 - 4 - 5 - 6 - 8 - 10 mm
- 1 click type torque wrench 3/8", 8+60 Nm
- 54 assortment of 52 hexagon bits, 10 mm, and 2 accessories
- 17 assortment of 12 sockets and 5 accessories
- 1 adaptor, 1/2" female and 3/8" male drives
- 2 3/8" square drive spark plug sockets \odot 16 - 17,8 mm
- 1 extra - long nose pliers \bullet 283 mm
- 2 circlip pliers straight, internal \odot 140 - 180 mm

Beta N.

- 30
- 32
- 34
- 42
- 55
- 96/SC9
- 606/6
- 867/C52
- 920A/C12X
- 910/16
- 956E
- 1009/LA
- 1032

Quantity/Description

- 1 circlip pliers straight, external \bullet 140x1,3 mm
- 1 diagonal cutting nippers ∇ 160 mm
- 1 electrician's scissors, straight blades
- 1 half-round needle nose pliers \equiv 180 mm
- 1 screwdriver for Dzus® head screws \bullet
- 4 screwdrivers for cross head Phillips® screws
 \bullet 3x75 - 4x100 - 5,5x100 - 6,5x150 mm
- 3 screwdrivers for cross head Phillips® screws
 \oplus PH0x60 - PH1x80 - PH2x100 mm
- 1 circuit testing screwdriver \bullet
- 1 engineer's hammer 300 g
- adjustable oil filter wrench
- 1 metric feeler gauge
- 1 mini hacksaw frame
- 1 brush, brass wires
- 1 plastic oil can 250 cc

Beta N.

- 1036
- 1082
- 1128BM
- 1150
- 1201DZ
- 1201
- 1202
- 1254
- 1370
- 1491
- 1708/13
- 1725CR
- 1737
- 1754

5940SBK

059400081

Assortment recommended in combination with C41S - C41H - C42S - C42H

Car repairs



24.6 kg

Quantity/Description

5	pin punches Ø 2 - 3 - 4 - 5 - 6 mm
1	centre punch Ø 4 mm
1	flat chisels 150 mm
18	combination wrenches 6 - 7 - 8 - 9 - 10 - 11 - 12 - 13 - 14 - 17 - 18 - 19 - 21 - 22 - 24 - 27 - 30 mm
12	double open end wrenches 6x7 - 8x9 - 10x11 - 12x13 - 14x15 - 16x17 - 18x19 - 20x22 - 21x23 - 24x26 - 27x29 - 30x32 mm
3	half - moon ring wrenches 11x13 - 14x17 - 19x22 mm
12	offset hexagon key wrenches Ø 2+10 mm
11	offset hexagon key wrenches Ø 2+8 - 10 mm
20	1/2" square drive hexagon sockets ○ 10+24 - 26 - 27 - 28 - 30 - 32 mm
5	1/2" drive, socket drivers for hexagon screws ○ 5 - 6 - 8 - 10 - 12 mm
1	1/2" drive extension bar 125 mm
1	1/2" drive extension bar 255 mm
1	1/2" drive universal joint
1	1/2" drive sliding T-handle
1	1/2" drive reversible ratchet
10	T - handle wrenches with swivelling socket ○ 6 - 7 - 8 - 10 - 11 - 12 - 13 - 14 - 17 - 19 mm
2	T - handle swivel spark plug wrenches 16 - 20,8 mm
1	wheel nut wrench ○ 17x19x22x ■ 1/2"
2	circlip pliers straight, internal ○ 140 - 180 mm
1	circlip pliers bent, internal ○ 170 mm
2	circlip pliers straight, external ● 140x1,3 - 175 mm
1	circlip pliers bent, external ● 175 mm
1	Slip joint pliers boxed joints 250 mm
1	self - locking pliers 240 mm

Beta N.

31
32
34
42
55
83
96
96T
920A
920ME
920/21
920/22
920/25
920/42
920/55
952
959
979
1032
1034
1036
1038
1048
1052

Quantity/Description

1	heavy duty diagonal cutting nippers ∇ 160 mm
1	tin snips 250 mm
1	electrician's scissors, straight blades
1	half-round needle nose pliers \equiv 180 mm
5	screwdrivers for cross head Phillips® screws ● 3x75 - 4x100 - 5,5x100 6,5x150 - 10x200 mm
2	screwdrivers for slotted head screws, extra-short series ● 4x30 - 6,5x30 mm
4	screwdrivers for cross head Phillips® screws ⊕ PH0x60 - PH1x80 PH2x100 - PH3x150 mm
2	screwdrivers for cross head Phillips® screws, extra - short series ⊕ PH1x30 - PH2x30 mm
1	screwdriver for cross head Phillips® screws, long series ⊕ PH2x400 mm
1	screwdriver for headless slotted screws, long series ● 6,5x400 mm
1	engineer's hammer 400 g
1	soft face hammer Ø 35 mm
1	circlip pliers for butt - ended circlips
1	adjustable oil filter wrench
1	crimping pliers for non insulated terminals
1	metric feeler gauge
1	flexible magnetic pick-up tool 0,5 kg
5	files 200 mm
1	hacksaw frame, aluminium handle
1	plastic oil can 250 cc

Beta N.

1084BM
1112
1128BMX
1150BM
1260
1260N
1262
1262N
1262L
1264L
1370
1390
1458
1491
1603
1708/13
1712E/1
1719BMA/S5
1726BM
1754

5953 VG

059530085

Assortment recommended in combination with C53VG

Car repairs

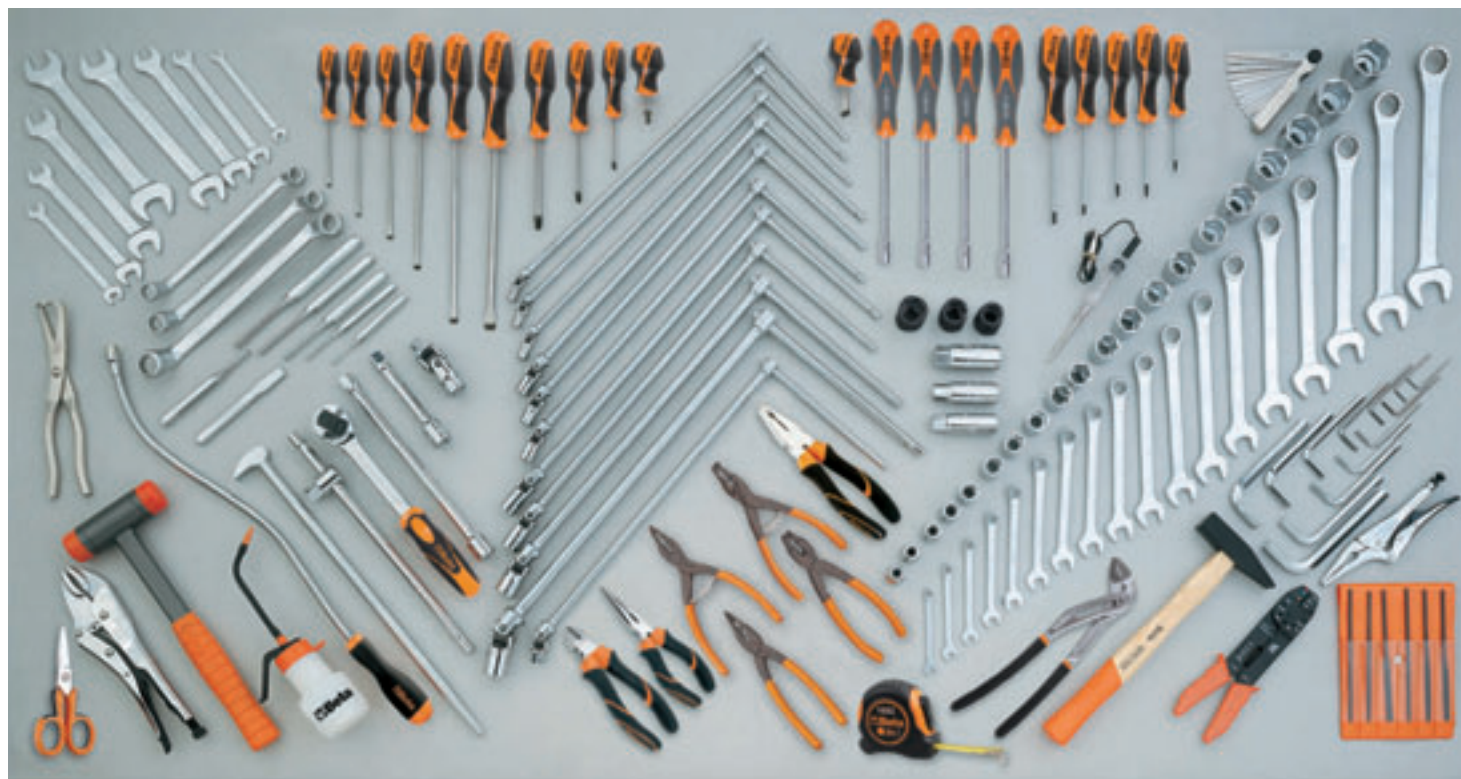

18.9 kg

Quantity/Description

5	pin punches Ø 2 - 3 - 4 - 5 - 6 mm
1	centre punch Ø 4 mm
1	flat chisels 125 mm
18	combination wrenches 6÷22 - 24 mm
8	double open end wrenches 6x7 - 8x9 - 10x11 - 12x13 - 14x15 - 16x17 - 18x19 - 20x22 mm
3	double ended offset ring wrenches 12x13 - 14x15 - 17x19 mm
13	offset hexagon key wrenches \odot 2÷10 - 12 mm
3	1/2" drive impact sockets \odot 17 - 19 - 22 mm
1	3/8" drive swivel T - handle
20	1/2" square drive hexagon sockets \odot 10÷24 - 26 - 27 - 28 - 30 - 32 mm
1	1/2" drive extension bar 125 mm
1	1/2" drive extension bar 255 mm
1	1/2" drive universal joint
1	1/2" drive sliding T-handle
1	1/2" drive reversible ratchet \oplus
4	hi-torque hexagon nut spinners, long series \odot 6 - 7 - 8 - 10 mm
10	T - handle wrenches with swivelling socket \odot 6 - 7 - 8 - 10 - 11 - 12 - 13 - 14 - 17 - 19 mm
3	3/8" square drive spark plug sockets \odot 16 - 17,8 - 20,8 mm
1	pry bar
1	circlip pliers straight, internal \odot 180 mm
1	circlip pliers bent, internal \odot 170 mm
1	circlip pliers straight, external \bullet 175 mm
1	circlip pliers bent, external \bullet 175 mm
1	Slip joint pliers boxed joints 250 mm
1	self - locking pliers 240 mm

Beta N.

31
32
34
42
55
90
96
720
910/40
920A
920/21
920/22
920/25
920/42
920/55
943BX
952
956E
964
1032
1034
1036
1038
1048
1052

Quantity/Description

1	adjustable self locking pliers, long jaws 180 mm	1058
1	diagonal cutting nippers ∇ 160 mm	1082BM
1	electrician's scissors, straight blades	1128BMX
1	half-round needle nose pliers \equiv 180 mm	1150BM
1	extra long needle knurled nose pliers, bi-material handles \bullet 160 mm	1166BM
1	circuit testing screwdriver \bullet 6÷24V	1254
6	screwdrivers for cross head Phillips® screws \bullet 3x75 - 3,5x100 - 4x125 5,5x150 - 6,5x150 - 10x200 mm	1260
1	screwdrivers for slotted head screws, extra-short series \bullet 6,5x30 mm	1260N
3	screwdrivers for cross head Phillips® screws \oplus PH0x60 - PH1x80 - PH2x100 mm	1262
1	screwdrivers for cross head Phillips® screws, extra - short series \oplus PH2x30 mm	1262N
5	drivers for Torx® head screws \odot T8 - T10 - T15 - T20 - T25	1267TX
1	engineer's hammer 300 g	1370
1	dead blow hammer Ø 35 mm	1392
1	brake spring pliers 210 mm	1470
1	crimping pliers for non insulated terminals	1603
1	measuring tape 5 m	1692
1	metric feeler gauge	1708/20
1	flexible magnetic pick-up tool 1,8 kg	1712E/2
6	needle files 160 mm	1720/B6
1	plastic oil can 150 cc	1754

5954 VG

059540085

Assortment recommended in combination with C54VG

Car repairs



36.6 kg

Quantity/Description

Beta N.

Quantity/Description

Beta N.

6	pin punches Ø 2 - 3 - 4 - 5 - 6 - 8 mm	31/SP6	2	circlip pliers bent, external ● 135x1,3 - 175 mm	1038
6	2 drift punches, 1 centre punch, 3 flat chisels with metal holder	38/SP6	1	Slip joint pliers boxed joints 250 mm	1048
19	combination wrenches 6+22 - 24 - 27 mm	42	1	self locking pliers, double adjustment	1051
12	double ended offset ring wrenches	90/S12X	1	heavy duty diagonal cutting nippers 160 mm	1084BM
	6x7 - 8x9 - 10x11 - 12x13 - 14x15 - 16x17		1	toggle lever assisted end cutting nippers 180 mm	1092V
	18x19 - 20x22 - 21x23 - 24x27 - 25x28 - 30x32 mm		1	tin snips 250 mm	1112
7	offset hexagon key wrenches ○ 2,5+10 mm	96N/G7	1	tin snip, straight narrow blades 250 mm	1114
12	offset hexagon key wrenches ○ 2+10 mm	96/SC12	1	electrician's scissors, straight blades	1128BMX
13	offset key wrenches for Torx® head screws ○ T6+T50	97TX/B13	1	half-round needle nose pliers = 180 mm	1150BM
5	offset key wrenches with XZN® profile M5+M12	98XZN/G	1	extra long needle knurled nose pliers, bi-material handles ● 160 mm	1166BM
1	adjustable wrench 250 mm	111	1	bent needle nose pliers ● 200 mm	1168BM
1	click type torque wrench 1/2", 40+200 Nm	606/20	7	screwdrivers for cross head Phillips® screws ● 3x75 - 3,5x100 - 4x125 - 5,5x150	1260
2	1/2" drive impact sockets ○ 17 - 19 mm	720		6,5x150 - 10x200 - 12x250 mm	
13	1/2" square drive bi-hex sockets with rail ○ 10+22 mm	920B/SB13	1	screwdrivers for slotted head screws	1260E
8	1/2" square drive bi-hex sockets with rail ○ 23+32 mm	920B/SB8		with hexagon bolsters ● 12x200 mm	
4	1/2" socket drivers for slotted head screws	920LP	3	screwdrivers for cross head Phillips® screws	1262
	● 1,2x6,5 - 1,2x8 - 1,6x9 - 2x12 mm			● PH0x60 - PH1x80 - PH2x100 mm	
3	1/2" socket drivers for Phillips® screws ● PH2 - 3 - 4	920PH	2	engineer's hammer 300 - 600 g	1370
1	1/2" drive extension bar 125 mm	920/21	1	soft face hammer Ø 35 mm	1390
1	1/2" drive extension bar 255 mm	920/22	11	roller stud extractors 6+12 mm	1433/C11
1	1/2" drive universal joint	920/25	1	adjustable oil filter wrench	1491
1	1/2" drive swivel handle	920/35A	1	circuit tester	1498
1	1/2" drive sliding T-handle	920/42	1	measuring tape 5 m	1692
1	1/2" drive reversible ratchet ⚙	920/55	1	metric feeler gauge	1708/20
10	T - handle wrenches with swivelling socket ○ 8 - 9 - 10 - 11 - 12 - 13 - 14 - 15 - 17 - 19 mm	952	1	flexible magnetic pick-up tool 1,8 kg	1712E/2
2	T - handle swivel spark plug wrenches 16 - 20,8 mm	959	1	two cutting edges scraper 200 mm	1717A
1	pry bar	963	1	three - cutting edges scraper 200 mm	1717B
1	bent point tweezers 120 mm	991	5	200 mm	1719BMA/S5
1	straight large point tweezers 150 mm	994	1	hacksaw frame, aluminium handle	1725
2	circlip pliers straight, internal ○ 140 - 180 mm	1032	1	metal oil can 200 cc	1751
2	circlip pliers bent, internal ○ 130 - 170 mm	1034	1	snap - off blade utility knife	1771
2	circlip pliers straight, external ● 140x1,3 - 175 mm	1036			

5957VG

059570060

Assortment recommended in combination with C57S A - C57S B - C57SP - C55PSP

Soft thermoformed trays M-series



Assortment of tools in thermoformed trays,
designed for roller cabs C22S, C23S, C23SC.

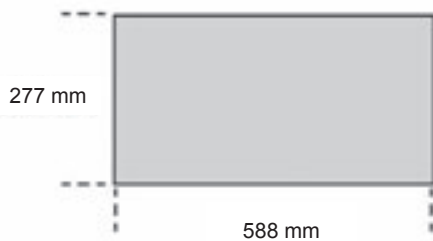
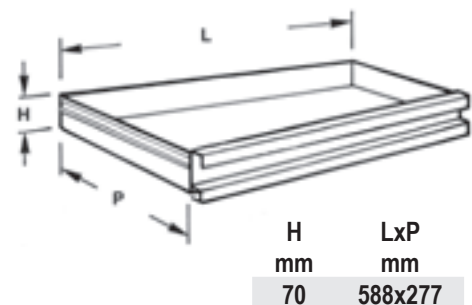

MC10

34



42	6-7-8-9-10-11-12 13-14-15-16-17 18-19-21-22 mm
96/SC9	1,5-2-2,5-3-4-5-6-8-10 mm
1084BM	160 mm
1150BM	180 mm
1166BM	160 mm
1201	3,5x100-5,5x150-6,5x150 mm
1202	PH0x60-PH1x80-PH2x100 mm

3,5 kg



MC10	1 027500010
MCV10	1 027510010

MC20

74



860MIX/A31	
895/1	
1048	250 mm
1370	300 g
32	Ø 4 mm
36	Ø 4 mm
900	4-4,5-5-5,5-6-7-8-9-10-11-12-13-14 mm
900/21	150 mm
900/25	
900BG/30C	
900/42	
900/55	
920A	10-11-12-13-14-15-16-17-18-19-21-22- 24-27-30-32 mm
920/25	
920AN/125	125 mm
920/42	
920/55	

6 kg

12"



MC20	1 027500020
MCV20	1 027510020

Soft thermoformed trays M-series



Assortment of tools in thermoformed trays, designed for C35.

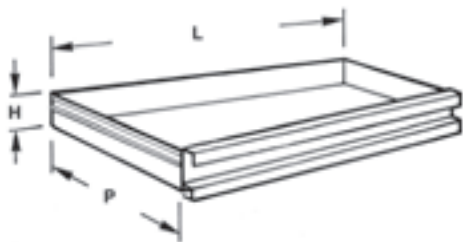

H mm	LxP mm
70	600x447

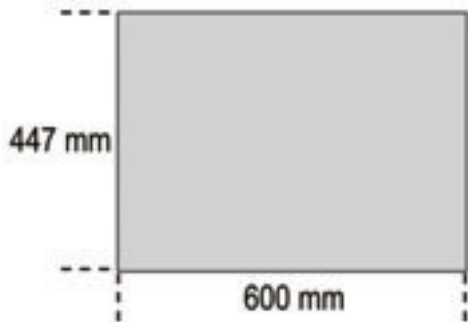

Beta

MB11



42	6-7-8-9-10-11-12-13-14-15-16-17-18-19-20-21-22-24-27-30-32 mm
55	6x7-8x9-10x11 12x13-14x15 16x17-18x19 20x22 mm
1048	250 mm

5,4 kg

MB11	1	024504211
MBV11	1	024524211

MB34



920A	10-11-12-13-14-15-16-17-18-19-20-21-22-23-24-26-27-30-32 mm
920/21	125 mm
920/22	150 mm
920/25	
920/42	
920/55	
111	250 mm
1052	240 mm
1084BM	160 mm
1150BM	180 mm
1166BM	160 mm
1032	180 mm
1034	170 mm
1036	175 mm
1038	175 mm
900	4-4,5-5-5,5-6-7-8-9-10-11-12-13-14 mm
900/20	50 mm
900/21	150 mm
900/25	
900BG/30	
900/55	
900/42	

7,0 kg

MB34	1	024504234
MBV34	1	024524234

MB35

80



96T	2-2,5-3-4-5-6-7-8 mm
851SR	230 mm
860LP	0,5x3 - 0,6x4,5 - 0,8x5,5 - 1x5,5 - 1,2x6,5 mm
860PE	2 - 2,5 - 3 - 4 - 5 - 6 - 8 - 10 mm
860PH	PH0 - PH1 - PH2 - PH3 - PH4
860PZ	PZ1 - PZ2 - PZ3 - PZ4
860RTX	T9-T10-T15-T20-T25-T27-T30-T40
860TX	T6-T7-T8-T9-T10-T15-T20-T25-T27-T30-T40
860/55	100 mm
882P	80 mm
892/0	
920A	10-11-12-13-14-15-16-17-18-19-20-21-22-24-26-27-30-32 mm
920/21	125 mm
920/22	250 mm
920/25	
920/42	
920/55	
1084BM	160 mm
1150BM	180 mm
1166BM	160 mm

5,9 kg

MB35	1	024504235
MBV35	1	024524235

MB36

39



920A	10-11-12-13-14-15-16-17-18-19-20-21-22-24-26-27-30-32 mm
920/21	125 mm
920/22	250 mm
920/25	
920/42	
920/55	
920PE	5-6-8-10-12 mm
1032	180 mm
1034	170 mm
1036	175 mm
1038	175 mm
35	200 mm
1084BM	160 mm
1150BM	180 mm
1166BM	160 mm
1370	500 g
1390	35 mm

7,2 kg

MB36	1	024504236
MBV36	1	024524236

MB44

34



- 1260 2,5x50-3x75-3,5x100-4x100-5,5x125-6,5x150-8x200 mm
- 1260N 4x30-6,5x30 mm
- ⊕ 1262 PH0x60-PH0x100-PH1x80-PH1x120-PH2x100-PH2x150-PH3x150 mm
- ⊕ 1262N PH1x30-PH2x30 mm
- 1253
- 96BPC/SC9
- 951 2,5-3-4-5-6-8 mm

2,8 kg



MB44	1	024504244
MBV44	1	024524244

MB45

29



- 1260 2,5x50-3x75-3,5x100-4x100-5,5x100-5x125-6,5x150 mm
- ⊕ 1262 PH0x60-PH0x100-PH1x80-PH1x120-PH2x100-PH2x150 mm
- ⊕ 1267TX T8-T10-T15-T20-T25-T30
- 1052 240 mm
- 96BPC/SC9

2,8 kg



MB45	1	024504245
MBV45	1	024524245

MB46

29

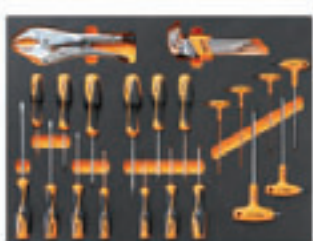

- 1260 3x75-4x100-5,5x125-6,5x150 mm
- ⊕ 1262 PH0x60-PH1x80-PH2x100 mm
- ⊕ 1267TX T8-T10-T15-T20-T25-T30
- 96BPC/SC9
- 96T 2-2,5-3-4-5-6
- 1052 240 mm

2,8 kg



MB46	1	024504246
MBV46	1	024524246

MB47

48

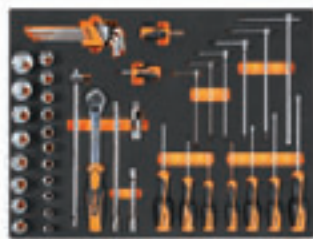

- 1260 3x75-4x100-5,5x125-6,5x150 mm
- ⊕ 1262 PH0x60-PH1x80-PH2x100 mm
- 1260N 4x30 mm
- ⊕ 1262N PH1x30 mm
- 96T 2,5-3-4-5-6-8 mm
- 96BPC/SC9
- 920A 10-11-12-13-14-15-16-17-18-19-20-21-22-23-24-26-27-30-32 mm
- 920/21 125 mm
- 920/22 250 mm
- 920/25
- 920/42
- ⊕ 920/55

5,6 kg



MB47	1	024504247
MBV47	1	024524247

MB55

17



- 31 Ø 2-3-4-5-6 mm
- 32 Ø 4 mm
- 35 200 mm
- 1112 250 mm
- 1128BMX
- 1370 500 g
- 1390 Ø 45 mm
- 1719BMA/Q 200 mm
- ▲ 1719BMA/T 200 mm
- 1719BMA/P 200 mm
- ▶ 1719BMA/M 200 mm
- 1719BMA/R 200 mm
- 1726 440 mm

4,5 kg



MB55	1	024504255
MBV55	1	024524255



MB56

15



- 1719BMA/Q 200 mm
- ▲ 1719BMA/T 200 mm
- 1719BMA/P 200 mm
- ▶ 1719BMA/M 200 mm
- 1719BMA/R 200 mm
- 1032 180 mm
- 1034 170 mm
- 1036 175 mm
- 1038 175 mm
- 1370T 300 g
- 1390N Ø 35 mm
- 35 200 mm
- 1692 5 mt
- 1725 260 mm
- 1771 18 mm

3,7 kg



MB56	1	024504256
MBV56	1	024524256

MB57

15



- 1719BMA/Q 200 mm
- ▲ 1719BMA/T 200 mm
- 1719BMA/P 200 mm
- ▶ 1719BMA/M 200 mm
- 1719BMA/R 200 mm
- 31 Ø 4-6 mm
- 32 Ø 4 mm
- 35 125-200 mm
- 1370 300 g
- 1390 Ø 35 mm
- 1692 5 mt
- 1725 420 mm
- 1835

3,4 kg



MB57	1	024504257
MBV57	1	024524257

MB61

16



■ 1719BMA/Q	200 mm
■ 1719BMA/P	200 mm
▲ 1719BMA/T	200 mm
▶ 1719BMA/M	200 mm
● 1719BMA/R	200 mm
35	200 mm
○ 1032	180 mm
○ 1034	170 mm
● 1036	175 mm
● 1038	175 mm
1052	240 mm
⚡ 1084BM	160 mm
≡ 1150BM	180 mm
● 1166BM	160 mm
1370	500 g
1390	∅ 35 mm

4,8 kg



MB61	1 024504261
MBV61	1 024524261

MB62

20



55	6x7-8x9-10x11 12x13-14x15 16x17-18x19 20x22 mm
1048MQ	250 mm
⚡ 1082MQ	140 mm
1128BSX	
1132MQ	230 mm
⚡ 1142MQ	160 mm
≡ 1150MQ	180 mm
● 1166MQ	160 mm
● 1168MQ	160 mm
110MQ	250 mm
1777MQ	
993MQ	
1602	

4,1 kg



MB62	1 024504262
MBV62	1 024524262

MB63

60

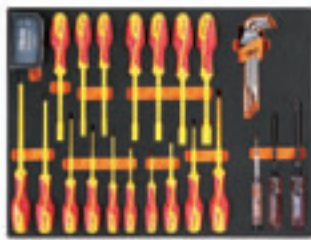

○ 96BPC/SC9	
● 1250	4x125 mm
● 1251	PH1x150 mm
● 1253	
○ 943MQ	5,5-6-7-8-10-13 mm
⊕ 1272MQ	PH0x60-PH1x80-PH2x100-PH3x150 mm
● 1274MQ	2,5x75-3x100-4x100-5,5x125-6,5x150-8x175 mm
● 860LP	0,5x3 - 0,6x4 - 0,8x5,5 1,0x5,5 - 1,2x6,5 mm
○ 860PE	2 - 2,5 - 3 - 4 - 5 - 6 8 - 10 mm
⊕ 860PH	PH0 - PH1 - PH2 - PH3 - PH4
⊕ 860PZ	PZ1 - PZ2 - PZ3 - PZ4
⊕ 860RTX	T9 - T10 - T15 - T20 T25 - T27 - T30 - T40
882MSR/50	○ 1/4 ● 1/4
● 850MQ	

3,2 kg



MB63	1 024504263
MBV63	1 024524263

Soft thermoformed trays M-series

Assortment of tools in thermoformed trays, designed for all roller cabs and trolleys.

The heights of drawers C1 and C2 are shown in order to choose the most suitable thermoformed tray. Near each thermoformed tray you will find the height of the drawer it is suitable for.

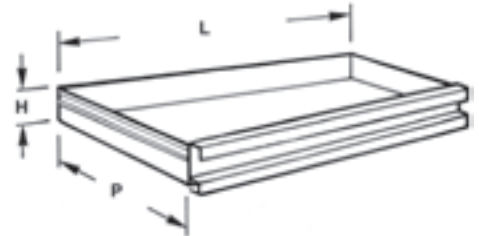

	H mm	LxP mm
C1	50	588x367
C2	70	588x367

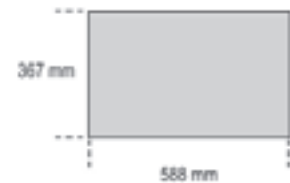
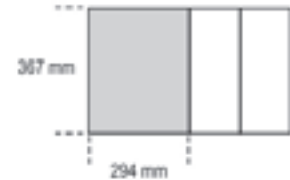
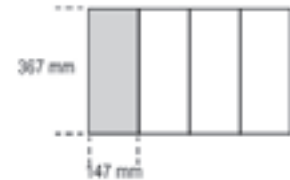

M10

22

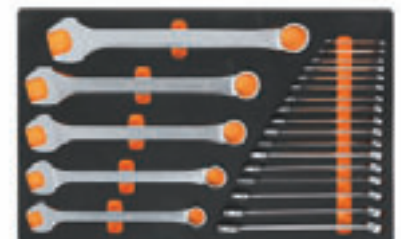

42	6-7-8-9-10-11-12-13-14-15-16-17-18-19-20-21-22-24-27-30-32-36 mm
----	--

4,5 kg

C2



M10	1 024500010
MV10	1 024510010

M15



42 6-7-8-9-10-11-12
13-14-15-16-17
18-19-20-21 mm

1,5 kg

C2



M15	1	024500015
MV15	1	024510015

M16



42 22-24-27-30-32 mm

2,1 kg

C2



M16	1	024500016
MV16	1	024510016

M30



55 6x7-8x9-10x11-12x13-14x15-16x17-
18x19-20x22-21x23-24x27-30x32 mm
90 6x7-8x9-10x11-12x13-14x15-16x17-
18x19-20x22-21x23-24x27-30x32 mm
96BPC/SC9 1,5-2-2,5-3-4-5-6-8-10 mm

4,2 kg

C2



M30	1	024500030
MV30	1	024510030

M33



55 6x7-8x9-10x11
12x13-14x15
16x17-18x19
20x22 mm
96/SC9 1,5+10 mm

1,1 kg

C2

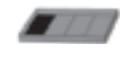

M33	1	024500033
MV33	1	024510033

M38



55 21x23-24x26
27x29-30x32 mm

1,7 kg

C1-C2



M38	1	024500038
MV38	1	024510038

M40



90 6x7-8x9-10x11
12x13-14x15
16x17-18x19 mm

810 g

C2



M40	1	024500040
MV40	1	024510040

M45



142 8-9-10-11-12
13-14-15-16
17-18-19 mm

1,3 kg

C2



M45	1	024500045
MV45	1	024510045

M46



142SN 8-9-10-11-12
13-14-15-16
17-18-19 mm

1,4 kg

C2



M46	1	024500046
MV46	1	024510046

M50



96T 2-2,5-3-4-5
6-7-8 mm

1,1 kg

C1-C2



M50	1	024500050
MV50	1	024510051

M52



96T 2,5-3-4-5-6 mm

330 g

C1-C2



M52	1	024500052
MV52	1	024510052

M53



96TBP 2,5-3-4-5-6 mm

350 g

C1-C2



M53	1	024500053
MV52	1	024510052



M55

5



97TTX T10-T15-T20-T25-T30

330 g

C1-C2



M55 1 024500055
MV55 1 024510055

M60

24



96T 2-2,5-3-4-5-6-7-8-10 mm
97BTX/SC8 T9-T10-T15-T20-T25-T27-T30-T40
944BX 5-6-7-8-10-13 mm

1,9 Kg

C1-C2



M60 1 024500060
MV60 1 024510060

M63

8



952 7-8-10-12-13-14-17-19 mm

3,4 kg

C1-C2



M63 1 024500063
MV63 1 024510063

M65

16

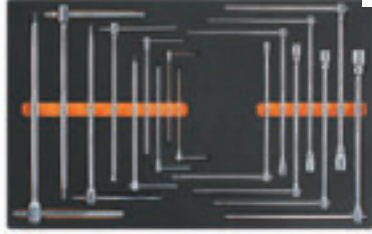

950 8-10-12-13-14-17-19 mm
951 2,5-3-4-5-6-8-10-12-14 mm

3,6 Kg

C1-C2



M65 1 024500065
MV65 1 024510065

M69

9



951 2,5-3-4-5-6-8
10-12-14 mm

1,8 kg

C1-C2



M69 1 024500069
MV69 1 024510069

M75

16



933 7-8-9-10-11-12-13-14-15
16-17-18-19-21-22-24 mm

5,5 kg

C2



M75 1 024500075
MV75 1 024510075

M79

6



80 8x9 -10x11-12x13
-14x15 16x17-18x19
mm

1,3 kg

C2

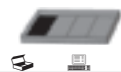

M79 1 024500079
MV79 1 024510079

M82

29



920A 10-11-12-13-14
15-16-17-18-19
20-21-22-23-24
26-27-30-32 mm
920ME 5-6-8-10-12 mm
920AN/125 125 mm
920AN/250 250 mm
920/25 305 mm
920/42 305 mm
920/55

4,1 kg

12"

C2



M82 1 024500082
MV82 1 024510082

M83

24



920A 10-11-12-13-14
15-16-17-18-19
20-21-22-23-24
26-27-30-32 mm
920AN/125 125 mm
920AN/250 250 mm
920/25 255 mm
920/42 305 mm
920/55

3,7 kg

12"

C2



M83 1 024500083
MV83 1 024510083

M85

45



851SR 230 mm
860LP 0,5x3 - 0,6x4,5
- 0,8x5,5 - 1x5,5 -
1,2x6,5 mm
860PE 2 - 2,5 - 3 - 4 - 5 - 6 - 8
- 10 mm
860PH PH0 - PH1 - PH2 -
PH3 - PH4
860PZ PZ1 - PZ2 - PZ3 - PZ4
860TX T6-T7-T8-T9-T10-T15-
T20-T25-T27-T30-T40
860RTX T9-T10-T15-T20-T25-
T27-T30-T40
860/55 100 mm
882P 80 mm
892 1/4 - 1/4

450 g

1/4"

C1-C2



M85 1 024500085
MV85 1 024510085

 Beta

 Beta

M86



- 867PE 4-5-6-7-8-10-12 mm
 - 867PE/L 4-5-6-7-8-10-12 mm
 - 867XZN 5-6-8-10-12 mm
 - 867XZN/L 5-6-8-10-12 mm
 - 867TX T20-T25-T30-T40-T45-T50-T55
 - 867TX/L T25-T30-T40-T45-T50-T55
 - 867RTX T20-T25-T30-T40-T45-T50-T55
- 867/1
867/2

1,4 kg



C1-C2

M86	1	024500086
MV86	1	024510086

M91



- 900 4-4,5-5-5,5-6-7-8-9-10-11-12-13-14 mm
- 900ME 2,5-3-4-5-6-8 mm
- 900/20 50 mm
- 900/21 150 mm
- 900/25 □ 1/4 - ■ 1/4
- 900BG/30
- 900/42
- ⊕ 900/55

560 g

14"

C2

M91	1	024500091
MV90	1	024510090

M92



- 910A 6-7-8-9-10-11-12-13-14-15-16-17-18-19-20-21-22 mm
- 910/21 125 mm
- 910/22 250 mm
- 910/25
- 910/42
- ⊕ 910/55

1,5 kg

3/8"

C2

M92	1	024500092
MV92	1	024510092

M100



- 895/1
- 895/3
- 895/6
- 900 4-4,5-5-5,5-6-7-8-9-10-11-12-13-14 mm
- 900L 5-6-7-8-9-10-11-12-13 mm
- 900ME 3-4-5-6-7 mm
- 900LP 0,8x4-1x5,5-1,2x6,5-1,2x8 mm
- ⊕ 900PH PH1-PH2-PH3-PH4
- ⊕ 900TX T10-T15-T20-T25-T27-T30-T40
- 900/20 50 mm
- 900/20L 100 mm
- 900/21 150 mm
- 900/25
- 900BG/30
- 900/42
- ⊕ 900/55
- 920A 8-10-11-12-13-14-15-16-17-18-19-20-21-22-23-24-26-27-28-30-32 mm
- 920/15
- 920/25
- 920AN/125 125 mm
- 920AN/250 250 mm
- 920/42
- ⊕ 920/55
- 920FTX 10-12-14-16-18-20-22-24 mm
- 920AL 10-12-13-14-15-16-17-18-19-21-22 mm

6,7 Kg

14" 12"

C2

M100	1	024500100
MV100	1	024510100

M110

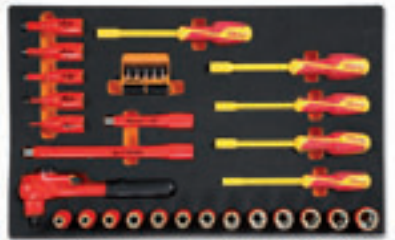

- ⊕ 850MQ
- ⊕ 860TX/A10
- 920MQ/A 8-9-10-11-12-13-14-15-16-17-18-19-20 mm
- 920MQ/PE 5-6-8-10-12 mm
- 920MQ/21 125 mm
- 920MQ/22 250 mm
- 920MQ/55A
- 943MQ 6-7-8-10 mm

3,1 kg

C2

M110	1	024500110
MV110	1	024510110

M112



- 861TX ● 1/4-T6+T15
- 866TX ● 5/16-T20+T55
- 895/1 ○ 1/4x□1/4
- 895/6 ○ 5/16x□1/2
- 900FTX □ 1/4-E4+E10
- 920FTX □ 1/2-E12+E24
- 920TX □ 1/2-T55L-T60-T70L

1,3 kg

14" 12"

C2

M112	1	024500112
MV112	1	024510112

M120



- 920A 10-11-12-13-14-15-16-17-18-19-20-21-22-24-26-27-30-32 mm
- 920AN/125 125 mm
- 920AN/250 250 mm
- 920/25
- 920/42
- 920AL 10-12-13-14-15-16-17-18-19-22-24-27-30-32 mm
- 920FTX 10-12-14-16-18-20-22-24 mm
- ⊕ 920/55
- 920PE 5-5L-6-6L-7-7L-8-8L-10-10L-12-12L-14-14L
- ⊕ 920TX T20-T25-T27-T30-T40-T45-T50-T55-T60-T20L-T25L-T27L-T30L-T40L-T45L-T50L

6,9 Kg

12"

C2

M120	1	024500120
MV120	1	024510120

M121

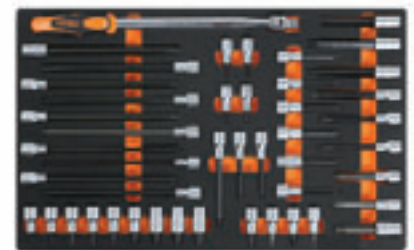

- 920BP 5L-6L-8L-10L-5XL-6XL-8XL mm
- ⊕ 920TX T20-T25-T27-T30-T40L-T45L-T50L-T55L-T60L-T70L
- 920XZN 4-5-6-6L-8-8L-10-10L-12-12L-14-14L-16-18 mm
- ⊕ 920ES 7-9-10-11-12L-14L-16L-7XL-9XL-10XL-11XL-12XL-14XL-16XL mm
- 920/36A

6,3 Kg

12"

C1-C2

M121	1	024500121
MV121	1	024510121

M130

13



- 1032 180 mm
- 1034 170 mm
- 1036 175 mm
- 1038 175 mm
- 1048 250 mm
- 1052 240 mm
- ◄ 1082BM 160 mm
- 1098 220 mm
- 1112 250 mm
- 1128BM
- ≡ 1150BM 180 mm
- 1166BM 160 mm
- 1168BM 160 mm

3,4 Kg

C1-C2

M130	1	024500130
MV130	1	024510130

M131

3



- ◄ 1084BM 160 mm
- ≡ 1150BM 180 mm
- 1166BM 160 mm

750 g

C1-C2

M131	1	024500131
MV131	1	024510131

M132

3



- ◄ 1084 160 mm
- ≡ 1150 180 mm
- 1166 160 mm

650 g

C1-C2

M132	1	024500132
MV132	1	024510132

M135

3



- ◄ 1082MQ 160 mm
- ≡ 1150MQ 180 mm
- 1166MQ 160 mm

750 g

C1-C2

M135	1	024500135
MV135	1	024510135

M145

4



- 1032 180 mm
- 1034 170 mm
- 1036 175 mm
- 1038 175 mm

640 g

C1-C2

M145	1	024500145
MV145	1	024510145

M153

2



- 1048 250 mm
- 1052 240 mm

1 kg

C1-C2

M153	1	024500153
MV153	1	024510153

M160

15



- 1128MQ
- 1048MQ 250 mm
- ◄ 1084MQ 200 mm
- ≡ 1150MQ 200 mm
- ≡ 1162MQ 160 mm
- ≡ 1164MQ 160 mm
- ⊕ 1272MQ PH0x60 - PH1x80 - PH2x100 - PH3x150 mm
- 1274MQ 2,5x75 - 3x100 - 4x100 - 5,5x125 mm
- 1777MQ/U

3,0 kg

C2

M160	1	024500160
MV160	1	024510160

M170

7



- 1290 2,5x50
- 3x75
- 3,5x100
- 4x125
- 5,5x100
- 5,5x150
- 6,5x150 mm

500 g

C1-C2

M170	1	024500170
MV170	1	024510170

M172

6



- ⊕ 1292 PH0x60
- PH0x100
- PH1x80
- PH1x120
- PH2x100
- PH2x150 mm

450 g

C1-C2

M172	1	024500172
MV172	1	024510172

M174

6



- ⊙ 1297TX T8-T10-T15-T20-T25-T30

450 g

C1-C2

M174	1	024500174
MV174	1	024510174

M180

7



- 1290 3x75
- 4x100
- 5,5x150
- 6,5x150 mm
- ⊕ 1292 PH0x60
- PH1x80
- PH2x100 mm

500 g

C1-C2

M180	1	024500180
MV180	1	024510180

M199



- 1260 2,5x50
3x75
3,5x100
4x125
5,5x100
5,5x150
6,5x150 mm

500 g

C1-C2



M199	1	024500199
MV199	1	024510199

M202



- ⊕ 1262 PH0x60
PH0x100
PH1x80
PH1x120
PH2x100
PH2x150 mm

450 g

C1-C2



M202	1	024500202
MV202	1	024510202

M204



- ⊙ 1267TX T8-T10-T15-T20-T25-T30

450 g

C1-C2



M204	1	024500204
MV204	1	024510204

M208



- 1260 3x75
3,5x100
4x125
5,5x150
6,5x150 mm
- ⊕ 1262 PH0x60
PH1x80
PH2x100 mm
- 1260N 4x30 mm
- ⊕ 1262N PH1x30 mm

750 g

C1-C2



M208	1	024500208
MV208	1	024510208

M210



- 1201 2,5x50-3x75-4x100-5,5x125-6,5x150-8x200 mm
- 1201N 4x30 mm
- ⊕ 1202 PH0x60-PH1x80-PH2x100-PH3x150 mm
- ⊕ 1202N PH1X30 mm
- ⊙ 1207TX T6-T7-T8-T9-T10-T15-T20-T25-T27-T30-T40-T45
- 1253

1,8 Kg

C1-C2



M210	1	024500210
MV210	1	024510210

M211



- 1201 2,5x50-3x75-3,5x100-4x125-5,5x100-5,5x150-6,5x150 mm

500 g

C1-C2



M211	1	024500211
MV211	1	024510211

M212



- ⊕ 1202 PH0x60-PH1x80-PH1x120-PH2x100-PH2x150-PH3x150 mm

450 g

C1-C2



M212	1	024500212
MV212	1	024510212

M215



- ⊙ 1207TX T6-T7-T8-T9-T10-T15-T20

500 g

C1-C2



M215	1	024500215
MV215	1	024510215

M220



- 1201 3x75
4x100
5,5x150
6,5x150 mm
- ⊕ 1202 PH0x60
PH1x80
PH2x100 mm

500 g

C1-C2



M220	1	024500220
MV220	1	024510220

M226



- 1274MQ 3x100
4x100
5,5x125
6,5x150 mm
- ⊕ 1272MQ PH0x60
PH1x80
PH2x100 mm

500 g

C1-C2



M226	1	024500226
MV226	1	024510226

M227



- ⊙ 944BX 6-7-8-10-13 mm

420 g

C1-C2



M227	1	024500227
MV227	1	024510227



M230

25

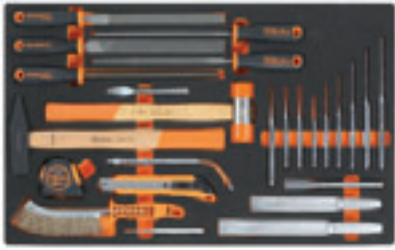

30	Ø 2-3-4 mm
31	Ø 2-3-4-5-6-8 mm
32	Ø 4 mm
34	150 mm
35	200-250 mm
36	125 mm
1370	500 g
1390	Ø 35 mm
1692	3 m
1712TF	
■ 1719BMA/Q	200 mm
▲ 1719BMA/T	200 mm
■ 1719BMA/P	200 mm
▶ 1719BMA/M	200 mm
● 1719BMA/R	200 mm
1737NX	
1771	18 mm

3,2 Kg



M230	1	024500230
MV230	1	024510230

M234

4



35	100-200 mm
1370	300 g
1390	Ø 35 mm

1,3 kg



M234	1	024500234
MV232	1	024510232

M236

5



- 1719BMA/Q 200 mm
- ▲ 1719BMA/T 200 mm
- 1719BMA/P 200 mm
- ▶ 1719BMA/M 200 mm
- 1719BMA/R 200 mm

870 g



M236	1	024500236
MV236	1	024510236

M237

5



35	100-200 mm
1370T	300 mm
1390N	Ø 35 mm

1,3 kg



M237	1	024500237
MV232	1	024510232

M240

7



31BM	Ø 2-3-4-5-6-8 mm
32	Ø 4 mm

850 g



M240	1	024500240
MV240	1	024510240

M264

16



1491	Ø 65+110 mm
■ 1494	■ 10 mm
○ 1494E	○ 8-9-10-11-12-14-17 mm
○ 1494Q	○ 8-9,5-12-13 mm
△ 1494T	△ 9,5
○ 1494XZN	○ 16
1496C	■ 8x ■ 10 mm

2,1 kg



M264	1	024500264
MV264	1	024510264

M285

4



1112	250 mm
1128BM	
1726	440 mm
1728BM	(5)
1753	200 cc

1,5 kg



M285	1	024500285
MV285	1	024510285

M288

9



1128BMX	
1130BMX	
■ 1719BMA/Q	200 mm
■ 1719BMA/P	200 mm
▶ 1719BMA/M	200 mm
● 1719BMA/R	200 mm
1726BM	400 mm
1728BM	(5)
1771BM	170 mm
1778V18	185 mm

2,4 Kg



M288	1	024500288
MV287	1	024510287

M289

4



1692	5 m
1725CR	
1755	30 cc
1771	

500 g



M289	1	024500289
MV289	1	024510289



M295



1650
1682
1707
1708/20



450 g

C1-C2



M295	1	024500295
MV295	1	024510295

M300



1927A
720

12-13-14-15-16-17
18-19-21-22
24-27 mm

720/21



4,7 kg

12"

C2



M300	1	024500300
MV300	1	024510300

M310



1927CD
720

12-13-14-15-16-17
18-19-21-22
24-27 mm

720/21



4,0 kg

12"

C2



M310	1	024500310
MV310	1	024510310

VPM3

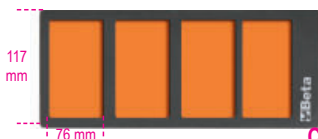

117 mm

76 mm

C1-C2



VPM3	1	088870353
------	---	-----------

VPM0



117 mm

337 mm

C1-C2



VPM0	1	088870350
------	---	-----------

Hard thermoformed trays T-series



Assortment of tools in thermoformed trays, designed for all roller cabs and all trolleys.

The heights of drawers C1 and C2 are shown in order to choose the most suitable thermoformed tray. Near each thermoformed tray you will find the height of the drawer it is suitable for.

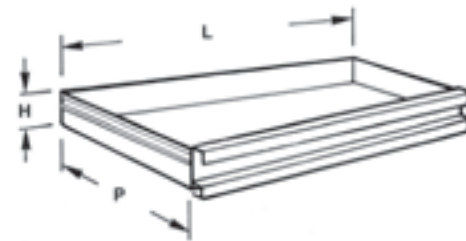

	H mm	LxP mm
C1	50	588x367
C2	70	588x367

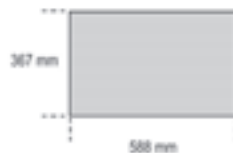
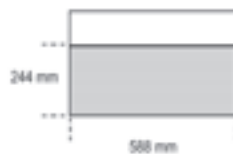
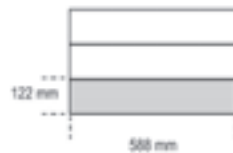
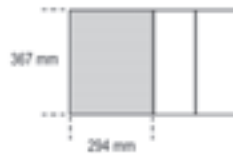
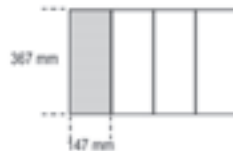

T10



42

6-7-8-10-11-12-13
14-16-17-18-19-21
22-24-27-30 mm



2,7 kg

C2



T10	1	024240010
TV10	1	024000400

T15



42

6-7-8-9-10-11-12
13-14-15-16-17
18-19-20-21 mm



1,5 kg

C2



T15	1	024240015
TV15	1	024000445

T16



42

22-24-27-30-32 mm



2,1 kg

C2



T16	1	024240016
TV16	1	024000446

T18



42MP

6-7-8-9-10-11-12
13-14-15-16-17
18-19-20-21 mm



1,5 kg

C2



T18	1	024240018
TV15	1	024000445

T19

5



42MP 22-24-27-30-32 mm

2,1 kg

C2

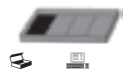

T19	1	024240019
TV16	1	024000446

T22

15



42AS 5/16-3/8-7/16-1/2
9/16-5/8-11/16-3/4
3/32-1/8-5/32-3/16
1/4-5/16-3/8

○96AS/BG7

1 kg

C2

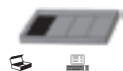

T22	1	024240022
TV20	1	024000488

T23

16



42INOX 8-10-11-12-13-14-15-
17-19 mm

○96BPINOX 2,5-3-4-5-6-8-10 mm



1 kg

C2



T23	1	024240023
TV23	1	024249906

T31

27



31 Ø 2-3-4-5-6 mm

32 Ø 4 mm

55 6x7-8x9-10x11
12x13-14x15
16x17-18x19
20x22-21x23
24x26-27x29
30x32 mm

○96N/SC9 1,5+10 mm

3 kg

C2



T31	1	024240031
TV30	1	024000401

T33

17



55 6x7-8x9-10x11
12x13-14x15
16x17-18x19
20x22 mm

○96/SC9 1,5+10 mm

1 kg

C2

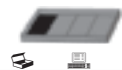

T33	1	024240033
TV20	1	024000488

T34

17



55MP 6x7-8x9-10x11
12x13-14x15
16x17-18x19
20x22 mm

○96/SC9 1,5+10 mm

1 kg

C2

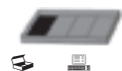

T34	1	024240034
TV20	1	024000488

T40

7



90 6x7-8x9-10x11
12x13-14x15
16x17-18x19 mm

810 g

C2



T40	1	024240040
TV40	1	024000456

T41

5



90 20x22-21x23
24x26-25x28
27x29 mm

1,5 kg

C2



T41	1	024240041
TV41	1	024000457

T45

12



142 8-9-10-11-12
13-14-15-16
17-18-19 mm

1,3 kg

C2

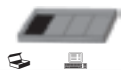

T45	1	024240045
TV45	1	024000498

T46

12

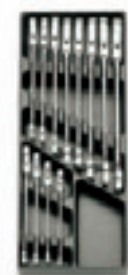

142SN 8-9-10-11-12
13-14-15-16
17-18-19 mm

1,5 kg

C2

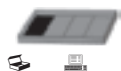

T46	1	024240046
TV46	1	024000499

T48

12



○96BPC/SC9 1,5+10 mm

142C 8-9-10-11-12
13-14-15-16
17-18-19 mm

1,4 kg

C2



T48	1	024240048
TV47	1	024000763

T50

11



○96T 2-2,5-3-3,5-4-4,5
5-6-7-8-10 mm

1,3 kg

C1 - C2



T50	1	024240050
TV50	1	024000764

T52



○96T 2-2,5-3-4-5-6 mm

350 g

C1 - C2



T52	1	024240052
TV52	1	024000765

T53



○96TBP 2,5-3-4-5-6 mm

300 g

C1 - C2



T53	1	024240053
TV52	1	024000765

T55



○97TTX T10-T15-T20
T25-T27-T30

330 g

C1 - C2



T55	1	024240055
TV55	1	024000766

T56



○96BP 2-3-4-5-6-8-10 mm
○97TX T20-T25-T30-T40-
T45-T50-T55

300 g

C1-C2



T56	1	024240056
TV56	1	024249901

T57



○96TINOX 2,5-3-4-5-6 mm



350 g

C1-C2



T57	1	024240057
TV57	1	024249907

T59



- 111 250 mm
- 920/40 1/2
- 951 2,5-3-4-5-6-8 mm
- 953 4-5-6-8 mm
- 1370 300 - 500 g

4,7 kg

C2



T59	1	024240059
TV60	1	024000420

T63



○952 7-8-10-12-13-14-17-19 mm

3,8 kg

C1 - C2



T63	1	024240063
TV63	1	024000471

T64



○952FTX E10-E12-E14
○953TX T25-T27-T30-T40-T45

3,8 kg

C1 - C2



T64	1	024240064
TV63	1	024000471

T65



○953 3-3,5-4-5-6-7-8-10 mm

2,8 kg

C1 - C2



T65	1	024240065
TV63	1	024000471

T68



○951 2,5-3-4-5-6-8 mm

590 g

C1 - C2



T68	1	024240068
TV68	1	024000470

T73



○930 6x7-8x9-10x11-12x13-
14x15-16x17-18x19-
20x22 mm

940/1

940/2

1,3 kg

C2



T73	1	024240073
TV73	1	024000418



T75

16



- 933 7-8-9-10-11-12-13
14-15-16-17-18-19
21-22-24 mm

4,2 kg



T75	1	024240075
TV75	1	024000422

T76

16



- 932 7-8-9-10-11-12-13
14-15-16-17-18-19
21-22-24 mm

4,2 kg



T76	1	024240076
TV75	1	024000422

T77

10



- 933 6-7-8-10-11-12-13
14-17-19 mm

1,4 kg



T77	1	024240077
TV77	1	024000474

T79

6



- 80 8x9-10x11-12x13
14x15-16x17
18x19 mm

1,3 kg



T79	1	024240079
TV79	1	024000490

T80

29



- 920A 10-11-12-13-14
15-16-17-18-19
20-21-22-23-24
26-27-30-32 mm
- 920ME 5-6-8-10-12 mm
- 920/21 125 mm
- 920/22 255 mm
- 920/25 305 mm
- 920/42 305 mm
- 920/55

4,1 kg

12"



T80	1	024240080
TV80	1	024000403

T81

29



- 920B 10-11-12-13-14
15-16-17-18-19
20-21-22-23-24
26-27-30-32 mm
- 920ME 5-6-8-10-12 mm
- 920/21 125 mm
- 920/22 255 mm
- 920/25 305 mm
- 920/42 305 mm
- 920/55

4,1 kg

12"



T81	1	024240081
TV80	1	024000403

T82

29



- 920A 10-11-12-13-14
15-16-17-18-19
20-21-22-23-24
26-27-30-32 mm
- 920ME 5-6-8-10-12 mm
- 920AN/125 125 mm
- 920AN/250 250 mm
- 920/25 305 mm
- 920/42 305 mm
- 920/55

4,1 kg

12"



T82	1	024240082
TV80	1	024000403

T83

24



- 920A 10-11-12-13-14
15-16-17-18-19
20-21-22-23-24
26-27-30-32 mm
- 920/21 125 mm
- 920/22 255 mm
- 920/25 305 mm
- 920/42 305 mm
- 920/55

3,6 kg

12"



T83	1	024240083
TV83	1	024000402

T85

81



- 861LP 0,5x3 - 0,6x4,5 - 0,8x5,5 - 1x5,5 - 1,2x6,5 - 1,2x8 - 1,6x8 mm
- 861PE 2 - 2,5 - 3 - 4 - 5 - 6 - 8 - 10 mm
- ⊕ 861PH PH0 - PH1 - PH2 - PH3
- ⊕ 861PZ PZ1 - PZ2 - PZ3
- ⊕ 861TX T6-T7-T8-T9-T10-T15-T20-T25-T27-T30-T40
- ⊕ 861RTX T9-T10-T15-T20-T25-T27-T30-T40
- ⊕ 861TRW 1-2-3-4-5-6 mm
- ⊕ 861TQS 0-1-2-3-4-5-6-8 mm
- ⊕ 861SP 4-6-8-10-12 mm
- 851SR 230 mm
- 900 4-4,5-5-5,5-6-7-8-9
10-11-12-13-14 mm
- 900/21 150 mm
- 900/25 41 mm
- 900BG/30 176 mm
- 900/42 115 mm
- 900/55 125 mm
- 194 1/4x5/16

1,0 kg

14"



T85	1	024240085
TV85	1	024000747

T91

25



- 900 4-4,5-5-5,5-6
7-8-9-10-11
12-13-14 mm
- 900ME 2,5-3-4-5-6-8 mm
- 900/20 50 mm
- 900/21 150 mm
- 900/25 150 mm
- 900BG/30 115 mm
- 900/42 115 mm
- 900/55

560 g

14"



T91	1	024240091
TV90	1	024000447

T92

22



- 910A 6-7-8-9-10-11-12-13
14-15-16-17-18-19
20-21-22 mm
- 910/21 125 mm
- 910/22 250 mm
- 910/25 210 mm
- 910/42 210 mm
- 910/55

1,5 kg

38"



T92	1	024240092
TV92	1	024000458

T100

16



- 920A 10-12-13-14-15
16-17-18-19-21
22-24 mm
- 920/21 125 mm
- 920/25 305 mm
- 920/42 305 mm
- Ⓢ 920/55

2,1 kg 12"



T100	1	024240100
TV100	1	024000495

T101

16



- 920B 10-12-13-14-15
16-17-18-19-21
22-24 mm
- 920/21 125 mm
- 920/25 305 mm
- 920/42 305 mm
- Ⓢ 920/55

2,1 kg 12"



T101	1	024240101
TV100	1	024000495

T102

16



- 920AS 3/8-7/16-1/2
9/16-5/8-11/16
3/4-13/16-7/8
15/16-1-1.1/16
- 920/21 125 mm
- 920/25 305 mm
- 920/42 305 mm
- Ⓢ 920/55

2,1 kg 12"



T102	1	024240102
TV100	1	024000495

T103

17



- 900L 6-7-8-9-10-11-12 mm
- 920AL 13-14-16-17-18-19
21-22-24-27 mm

1,1 kg 14" 12"



T103	1	024240103
TV103	1	024000748

T105

11



- 928A 22-24-27-30-32-34
36-38-41-46-50 mm

4,9 kg 3/4"



T105	1	024240105
TV105	1	024000484

T106

4



- 928/21 200 mm
- 928/22 380 mm
- 928/42 450 mm
- 928/55

4,5 kg 3/4"



T106	1	024240106
TV106	1	024000485

T110

14



- 720 10-11-12-13-14
16-17-18-19-21
22-23-24 mm
- 720/21 125 mm

1,8 kg 12"



T110	1	024240110
TV110	1	024000477

T112

32



- ⊕ 861TX ● 1/4-T6+T15
- ⊕ 866TX ● 5/16-T20+T55
- 895/1 ○ 1/4x□1/4
- 895/6 ○ 5/16x□1/2
- 900FTX □ 1/4-E4+E10
- 920FTX □ 1/2-E12+E24
- 920TX □ 1/2-T55L-T60-T70L

1,3 kg 14" 12"



T112	1	024240112
TV112	1	024000480

T113

12



- 920PE 5L-6L-7L-8L-10L
- ⊕ 920TX T40L-T45L
T55L-T70L
- 920XZN M6L-M8L-M12L

1,5 kg 12"



T113	1	024240113
TV113	1	024000489

T120

1



606/20 40-200 Nm

1,1 kg 12"



T120	1	024240120
TV120	1	024000483

T131

3



- ⊕ 1084BM 160 mm
- ⊕ 1150BM 180 mm
- ⊕ 1166BM 160 mm

750 g



T131	1	024240131
TV130	1	024000451

T132

3



- ⊕ 1084 160 mm
- ⊕ 1150 180 mm
- ⊕ 1166 160 mm

650 g



T132	1	024240132
TV130	1	024000451

T135



- ◄ 1082MQ 160 mm
- ▬ 1150MQ 180 mm
- 1166MQ 160 mm

⚡ 1000 V

📦 750 g

C1 - C2



T135	1	024240135
TV135	1	024000762

T145



- 1032 180 mm
- 1034 170 mm
- 1036 175 mm
- 1038 175 mm

📦 640 g

C1 - C2



T145	1	024240145
TV145	1	024000448

T154



- ◄ 1082 160 mm
- ▬ 1150 180 mm
- 1048 250 mm

📦 1 kg

C1-C2



T154	1	024240154
TV148	1	024000500

T136



- 1048MQ 250 mm
- 1777MQ/U

📦 700 g

C1-C2



T136	1	024240136
TV136	1	024000438

T146



- 1032 140x0,9 mm
- 1032 225 mm
- 1036 140x1,3 mm
- 1036 225 mm

📦 700 g

C1 - C2



T146	1	024240146
TV146	1	024000449

T155



- ◄ 1082BM 160 mm
- ▬ 1150BM 180 mm
- 1048BM 250 mm

📦 1,1 kg

C1-C2



T155	1	024240155
TV148	1	024000500

T140



- 1032 140x0,9 - 180 mm
- 1034 170 mm
- 1036 140x1,3 - 175 mm
- 1038 175 mm
- ◄ 1084 160 mm
- 1128BM

📦 1,1 kg

C1 - C2



T140	1	024240140
TV140	1	024000405

T151



- 1047 240 mm
- 1057A 240 mm

📦 1,3 kg

C2



T151	1	024240151
TV150	1	024000462

T160



- 1290 3x75
- 3x100
- 4x100
- 4x150
- 5,5x100
- 5,5x150
- 6,5x150
- 8x150
- 10x200 mm
- 1290N 4x30
- 6,5x30 mm

📦 1,3 kg

C1 - C2



T160	1	024240160
TV160	1	024000706

T142



- 1048 250 mm
- 1052 240 mm
- 1112 250 mm
- ▬ 1150 180 mm

📦 1,8 kg

C1 - C2



T142	1	024240142
TV143	1	024000409

T153



- 1048 250 mm
- 1052 240 mm

📦 1,1 kg

C1 - C2



T153	1	024240153
TV150	1	024000462

T161



- 1292 PH0x60
- PH0x100
- PH1x80
- PH1x120
- PH2x100
- PH2x150
- PH3x150 mm
- 1292N PH1x30
- PH2x30 mm

📦 1 kg

C1 - C2



T161	1	024240161
TV161	1	024000707

T164

16



- 952 8-10-13-17-19 mm
- 959 16 mm (5/8") - 20,8 mm (13/16")
- 1260 3x75-4x100-5,5x100
6,5x150-10x200 mm
- ⊕ 1262 PH0x60-PH1x80
PH2x100-PH3x150 mm

5 kg

C1 - C2



T164	1	024240164
TV61	1	024000721

T167

11



- 1260 3x75
3x100
4x100
4x150
5,5x100
5,5x150
6,5x150
8x150
10x200 mm
- 1260N 4x30
6,5x30 mm

1,3 kg

C1 - C2



T167	1	024240167
TV160	1	024000706

T168

9



- ⊕ 1262 PH0x60
PH0x100
PH1x80
PH1x120
PH2x100
PH2x150
PH3x150 mm
- ⊕ 1262N PH1x30
PH2x30 mm

1 kg

C1 - C2



T168	1	024240168
TV161	1	024000707

T170

7



- 1290 2,5x50
3x75
3,5x100
4x125
5,5x100
5,5x150
6,5x150 mm

450 g

C1 - C2



T170	1	024240170
TV170	1	024000741

T171

5



- 1290 8x150
8x200
10x200 mm
- 1290N 4x30
6,5x30 mm

750 g

C1 - C2



T171	1	024240171
TV171	1	024000742

T172

6



- ⊕ 1292 PH0x60
PH0x100
PH1x80
PH1x120
PH2x100
PH2x150 mm

450 g

C1 - C2



T172	1	024240172
TV172	1	024000743

T173

4



- ⊕ 1292 PH3x150
PH4x200 mm
- ⊕ 1292N PH1x30
PH2x30 mm

560 g

C1 - C2



T173	1	024240173
TV173	1	024000744

T175

7



- 1297TX T6-T7-T8-T9
T10-T15-T20

410 g

C1 - C2



T175	1	024240175
TV175	1	024000760

T176

5



- 1297TX T25-T27-T30
T40-T45

640 g

C1 - C2



T176	1	024240176
TV176	1	024000761

T177

8



- ⊕ 1298RTX T9-T10-T15
T20-T25-T27
T30-T40

680 g

C1 - C2



T177	1	024240177
TV177	1	024000759

T180

7



- 1290 3x75
4x100
5,5x150
6,5x150 mm
- ⊕ 1292 PH0x60
PH1x80
PH2x100 mm

480 g

C1 - C2



T180	1	024240180
TV180	1	024000701

 **Beta**

T183

Betamax

5



- 1292L PH1x400-PH2x400 mm
- 1294L 3x300-4x400-5x400 mm

580 g

C2



T183	1	024240183
TV183	1	024000497

T198

7



- 1260 3x75
4x100
5.5x150
6.5x150 mm
- 1269PZ PZ0 - PZ1 - PZ2

490 g

C1 - C2



T198	1	024240198
TV180	1	024000701

T199

7



- 1260 2.5x50
3x75
3.5x100
4x125
5.5x100
5.5x150
6.5x150 mm

490 g

C1 - C2



T199	1	024240199
TV170	1	024000741

T201

5



- 1260 8x200
10x150
10x200 mm
- 1260N 4x30
6.5x30 mm

680 g

C1 - C2



T201	1	024240201
TV171	1	024000742

T202

6



- 1262 PH0x60
PH0x100
PH1x80
PH1x120
PH2x100
PH2x150 mm

490 g

C1 - C2



T202	1	024240202
TV172	1	024000743

T204

4



- 1262 PH3x150
PH4x200 mm
- 1262N PH1x30
PH2x30 mm

610 g

C1 - C2



T204	1	024240204
TV173	1	024000744

T205

7



- 1267TX T6-T7-T8-T9
T10-T15-T20

460 g

C1 - C2



T205	1	024240205
TV175	1	024000760

T206

5



- 1267TX T25-T27-T30
T40-T45

710 g

C1 - C2



T206	1	024240206
TV176	1	024000761

T207

7



- 1268RTX T9-T10-T15
T20-T25-T27-T30

760 g

C1 - C2



T207	1	024240207
TV207	1	024000758

T208

7



- 1260 3x75
4x100
5.5x150
6.5x150 mm
- 1262 PH0x60
PH1x80
PH2x100 mm

530 g

C1 - C2



T208	1	024240208
TV180	1	024000701

T209

5



- 1262L PH1x400-PH2x400 mm
- 1264L 3x300-4x400-5x400 mm

580 g

C2



T209	1	024240209
TV183	1	024000497



T210



- 1201 2,5x50
3x75
3,5x100
4x125
5,5x100
5,5x150
6,5x150 mm



490 g

C1 - C2



T210	1	024240210
TV170	1	024000741

T212



- ⊕ 1202 PH0x60
PH1x80
PH1x120
PH2x100
PH2x150
PH3x150 mm



490 g

C1 - C2



T212	1	024240212
TV212	1	024000440

T215



- ♻️ 1207TX T6-T7-T8-T9
T10-T15-T20



410 g

C1 - C2



T215	1	024240215
TV175	1	024000760

T220



- 1201 3x75
4x100
5,5x150
6,5x150 mm
- ⊕ 1202 PH0x60
PH1x80
PH2x100 mm



530 g

C1 - C2



T220	1	024240220
TV180	1	024000701

T226



- 1274MQ 3x100
4x100
5,5x125
6,5x150 mm
- ⊕ 1272MQ PH0x60
PH1x80
PH2x100 mm



460 g

C1 - C2



T226	1	024240226
TV180	1	024000701

T227



- 944BX 5-6-7-8-10-13 mm



490 g

C1 - C2



T227	1	024240227
TV227	1	024000705

T228



- 1290INOX 3x75 - 4x100 -
5,5x150 - 6,5x150 mm
- ⊕ 1292INOX PH0x60 - PH1x80 -
PH2x100 mm



480 g

C1 - C2



T228	1	024240228
TV180	1	024000701

T231



- 1370 400 g
- 1390 Ø 35 mm
- ▲ 1719BMA/T 200 mm
- 1719BMA/P 200 mm
- ▷ 1719BMA/M 200 mm



1,7 kg

C2



T231	1	024240231
TV230	1	024000411

T233



- 35 100-200 mm
- 1370F 32 mm
- 1390 Ø 35 mm



1,3 kg

C1 - C2



T233	1	024240233
TV232	1	024000452

T234



- 35 100-200 mm
- 1370 300 g
- 1390 Ø 35 mm



1,3 kg

C1 - C2



T234	1	024240234
TV232	1	024000452

T236



- 1719BMA/Q 200 mm
- ▲ 1719BMA/T 200 mm
- 1719BMA/P 200 mm
- ▷ 1719BMA/M 200 mm
- 1719BMA/R 200 mm



870 g

C1 - C2



T236	1	024240236
TV235	1	024000453

T239



- 31BM Ø 2-3-4-5-6-8 mm
- 32 Ø 4 mm



850 g

C1 - C2



T239	1	024240239
TV239	1	024000439

T241



1500N/1
1500N/3
1516/1

4,2 kg

T241	1	024240241
TV241	1	024000414

T250

Automotive



34 150 mm
83/S3 11x13-14x17
19x22 mm
1458 175 mm
1491
1603
1708/13 0,05±1 mm

1430 g

T250	1	024240250
TV250	1	024000408

T256

Automotive



○ 956E 16 mm (5/8) - 20,8 mm (13/16)
○ 956L 16 mm (5/8) - 20,8 mm (13/16)
959 16 mm (5/8) - 20,8 mm (13/16)
■ 1164 200 mm
1708/20 0,05±1 mm

3,2 kg

T256	1	024240256
TV255	1	024000467

T259



○ 96BP 2,5-3-4-5
6-8-10 mm
○ 96N 12 mm
● 860MIX/A31
○
+
+
+
895/1

950 g

T259	1	024240259
TV263	1	024000492

T264



1491 Ø 65±110 mm
■ 1494 ■ 10 mm
○ 1494E ○ 8-9-10-11-12-14-17 mm
○ 1494Q ○ 8-9-5-12-13 mm
△ 1494T △ 9,5
○ 1494XZN ○ 16
1496C ■ 8x ■ 10 mm

2,1 kg

T264	1	024240264
TV264	1	024000466

T270



430 M3 - 4 - 5 - 6 - 7 - 8 - 9
10 - 12 - 14 - 16 - 18 - 20
433 M6x0,75 - M8x1 - M10x1,25
M12x1,5 - M14x1,5
M16x1,5 - M18x1,5
440 M3 - 4 - 5 - 6 - 7 - 8 - 9
440A M10 - 12 - 14 - 16 - 18 - 20
441 M6x0,75 - M8x1,0
441A M10x1,25 - M12x1,5
M14x1,5 - M16x1,5
M18x1,5

4,3 kg

T270	1	024240270
TV270	1	024000481

T273



435/1,5 M3+M12
435/3 M5+M21
436/1 □ 2,0+5,0 mm
(M3+M8)
436/2 □ 4,6+8 mm
(M5+M12)
444/1 Ø 25,4 mm
444/2 Ø 38,1 mm
1707 W 62±4x1"

2,1 kg

T273	1	024240273
TV272	1	024000482

T281



1741B 250 mm
1741RV2,9K 2,9x6 mm (100)
1741RV3,2K 3,2x8 mm (100)
1741RV3,8K 3,8x10 mm (100)
1741RV4K 4x12 mm (100)

1,4 kg

T281	1	024240281
TV280	1	024000478

T285



1112 250 mm
1128BM -
1726 400 mm
1728BM (5)
1753 200 cc

1,5 kg

T285	1	024240285
TV285	1	024000487

Beta

Beta

T288

10



1128BMX	
1130BMX	
■ 1719BMA/Q	200 mm
▲ 1719BMA/T	200 mm
■ 1719BMA/P	200 mm
● 1719BMA/M	200 mm
● 1719BMA/R	200 mm
1726BM	400 mm
1728BM	
1771BM	170 mm
1778V18	185 mm

2,9 Kg

C2

T288	1	024240288
TV286	1	024249904

T289

4



1692	5 m
1725CR	-
1755	30 cc
1771	-

500 g

C2

T289	1	024240289
TV290	1	024000455

T291

3



1479RB/1	
1479RB/2	
1479RB/3	

600 g

C2

T291	1	024240291
TV291	1	024000472

T297

3



1651DGT	
1682	
1691BM	

490 g

C1 - C2

T297	1	024240297
TV296	1	024000749

VP1 - VP2

thermoformed trays for small items, made from plastic for all roller cabs C22, C23, C23C

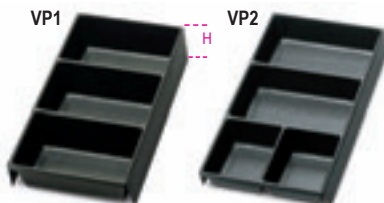

	H mm	
VP1	50	1 088880351
VP2	35	1 088880352

VP3 - VP4

thermoformed trays for small items, made from plastic for all roller cabs and all trolleys

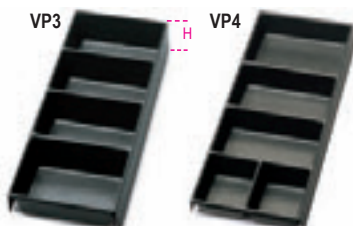

	H mm	
VP3	45	1 088880353
VP4	35	1 088880354

VP5

thermoformed tray



VP5	1	088880355
-----	---	-----------

VP6

thermoformed tray



C2

VP6	1	088880359
-----	---	-----------

VP-3SC

thermoformed tool trays, made from plastic, for mobile roller cab C38

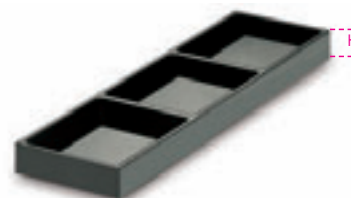

C1-C2

	H mm	
VP-3SC	45	1 088880356

VP-LS

thermoformed tool trays, made from plastic, for mobile roller cab C38



C1-C2

	H mm	
VP-LS	45	1 088880357

VP-LD

thermoformed tool trays, made from plastic, for mobile roller cab C38



C1-C2

	H mm	
VP-LD	45	1 088880358

8889P1

parallel partitions for item C22S e C27S drawer 588x257 mm



	h	
8889P1/5	50 mm	1 088890005
8889P1/7	70 mm	1 088890007

8889C1

crossed partitions for item C22S and C27S

for drawer 588x257 mm



	h		
8889C1/5	50 mm	1	088890015
8889C1/7	70 mm	1	088890017

8889P2

parallel partitions for standard drawer 588x367 mm



	h		
8889P2/7	70 mm	1	088890107

8889C2

crossed partitions for standard drawer 588x367 mm



	h		
8889C2	70 mm	1	088890117

8889P3

parallel partitions for item C24SA-XL

for drawer 882x367 mm



	h		
8889P3	70 mm	1	088890207

8889C3

crossed partitions for C24SA-XL

for drawer 882x367 mm



	h		
8889C3	70 mm	1	088890217

8889P4

parallel partitions for item C41

for drawer 418x205 mm



	h		
8889P4	70 mm	1	088890307

8889I4

crossed partition for item trolley C41

for drawer 418x205 mm



	h		
8889C4	70 mm	1	088890317

8889PS

parallel partitions for item C38

left side drawer 570x410 mm



	h		
8889PS/7	70 mm	1	088890407

8889CS

crossed partitions for item C38

left side drawer 570x410 mm



	h		
8889CS/7	70 mm	1	088890417

8889PD

parallel partitions for item C38

right side drawer 313x410 mm



	h		
8889PD/7	70 mm	1	088890427

8889CD

crossed partitions for item C38

right side drawer 313x410 mm



	h		
8889CD/7	70 mm	1	088890437

8889C6

crossed partitions for item C35

for drawer 600x447 mm



	h		
8889C6/7,5	75 mm	1	088890475
8889C6/10	100 mm	1	088890480
8889C6/15	150 mm	1	088890485
8889C6/20	200 mm	1	088890490

SB

socket rails



	L mm		
SB1	210	10	088880201
SB2	280	10	088880202
SB3	360	10	088880203

MB

socket clips for rails SB



MB0	1/4	50	088880210
MB1	3/8	50	088880211
MB2	1/2	50	088880212

KIT/GPS

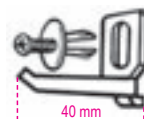

KIT/GPS	40 mm	50	088880119

VE1



VE1		20	088880120

GM



∅ mm			
6,5		5	088880250
9,5		5	088880251
13		5	088880252
16		5	088880253
19		5	088880254
25		5	088880255

S55/8

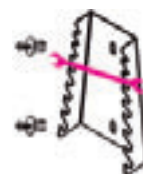

S55/8		1	088880420
55/S8			
55AS/8			
55MP/S8			

S55/12

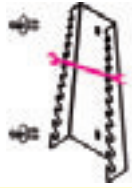

S55/12
55/S12
55/S12X
55AS/12
55MP/S12

1 088880421

ST2P

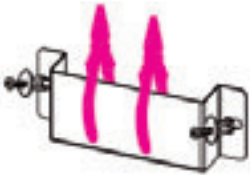

ST2P

1 088880422

TSPP

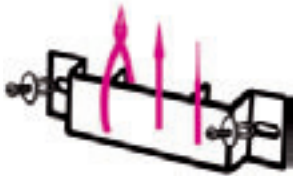

TSPP

1 088880402

S952/10

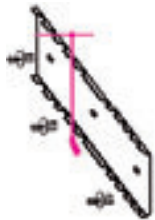

S952/10

1 088880423

S1719BM



S1719BM
1719BMA: Q-T-P-M-R
1719BMD: Q-T-P-M-R

1 088880404

SGN



SGN
1290N-1292N-1299N/PZ
1260N-1262N-1269N/PZ
1201N-1202N-1209N/PZ

1 088880405

CB/2

only for C54

12"

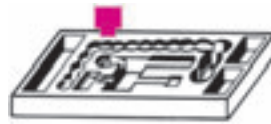

CB/2
920A/920B
10=24+26-27
28-30-32 mm
920/21-920/22-920/25-
920/42-920/55

1 088880411

S42/17



S42/17
42/S17
42MP/S17
42/S17X
42AS/17
142/S17

1 088880428

S951/6



S951/6
951/S6
951AS/S6X
951TX/S6

1 088880429

SPG11 - S1203/8

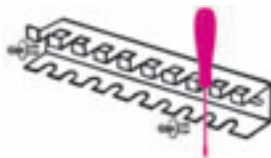

SPG11
n.8 Ø = 7 mm
n.2 Ø = 10 mm
n.1 Ø = 12 mm

S1203/8
1203/S8
1263/D8
1293/S8

1 088880910

1 088880430

S96T/8



S96T/8

1 088880431

96T/SPV

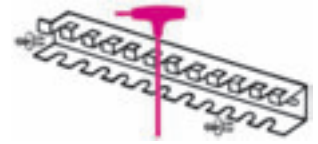

96T/SPV
96T/S11
97TTX/S11

1 000960958



Beta

BLISTER PACK RANGE

free-service sales!

- Increased visibility
- Display efficiency
- Bar code



Blister pack support:

- tearproof PVC
- 4 formats for optimized display space
- New-generation fixing system with elastic band

42K



mm	🔧	📦
24x27	2	000909067
25x28	2	000909070
27x29	2	000909073
30x32	2	000909080

93K



mm	🔧	📦
21x22	3	000939021

94K



mm	🔧	📦
8x10	2	000949008
9x11	2	000949009
10x11	2	000949010
11x13	2	000949011
12x14	2	000949012
13x15	2	000949013
14x15	2	000949014
14x17	2	000949015
17x19	2	000949017
19x22	2	000949019
22x24	2	000949022
24x27	2	000949024
30x32	2	000949030

96/SC9



96/SC9	🔧	📦
1,5-2-2,5-3-4-5-6-8-10 mm	1	000960374

96/ST6K



96/ST6K	🔧	📦
2,5-3-4-5-6-8 mm	3	000969370

96N/ST6K



96N/ST6K	🔧	📦
2,5-3-4-5-6-8 mm	3	000969640

96BPA/SC9



96BPA/SC9	🔧	📦
1,5-2-2,5-3-4-5-6-8-10 mm	1	000961974

96BPC/SC9



96BPC/SC9	🔧	📦
1,5-2-2,5-3-4-5-6-8-10 mm	1	000960354

96C/AS



"	🔧	📦
1/16	20	000961702
3/32	20	000961706
1/8	20	000961710
5/32	20	000961714
3/16	20	000961716
7/32	20	000961718
1/4	20	000961720
5/16	10	000961724
3/8	10	000961728

96LBP/SC9



96LBP/SC9	🔧	📦
1,5-2-2,5-3-4-5-6-8-10 mm	1	000961354

96/BGS7



96/BGS7	🔧	📦
1,5-2-2,5-3-4-5-6 mm	1	000960367

55K



mm	🔧	📦
6x7	5	000559012
8x9	5	000559021
10x11	5	000559030
10x12	5	000559033
10x13	5	000559035
12x13	5	000559042
12x14	5	000559045
13x17	5	000559051
14x15	5	000559054
14x17	5	000559057
16x17	5	000559060
17x19	2	000559063
18x19	2	000559066
19x22	2	000559069
20x22	2	000559075
21x23	2	000559078
22x24	2	000559081
24x26	2	000559087
24x27	2	000559090
25x28	2	000559096
27x29	2	000559099
27x30	2	000559102
30x32	2	000559108

90K



mm	🔧	📦
6x7	5	000909006
8x9	5	000909012
10x11	5	000909018
12x13	5	000909027
14x15	5	000909033
16x17	5	000909039
18x19	5	000909045
20x22	3	000909051
21x23	2	000909057
24x26	2	000909063

96/BG7



96/BG7
2,5-3-4-5-6-8-10 mm

1 000960368

96TK



mm		
2	5	000969934
2,5	5	000969935
3	5	000969936
4	5	000969938
5	5	000969940
6	5	000969941
8	3	000969943
10	3	000969945

97BTX/SC8



97BTX/SC8
T9-T10-T15-T20-T25-T27-T30-T40

1 000970164

97BTXL/SC8



97BTXL/SC8
T9-T10-T15-T20-
T25-T27-T30-T40

1 000970364

111K



L mm		
100	3	001119010
150	5	001119015
200	5	001119020
250	5	001119025
300	3	001119030

123/K4



123/K4

1 001230504

142K



mm		
6	3	001429006
7	3	001429007
8	3	001429008
9	3	001429009
10	3	001429010
11	3	001429011
12	3	001429012
13	3	001429013
14	2	001429014
15	2	001429015
16	2	001429016
17	2	001429017
18	2	001429018
19	2	001429019
21	1	001429021
22	1	001429022
24	1	001429024

192/S2



192/S2
8x10/12x13
16x17/18x19 mm

1 001920070

195K



mm		
8x10	2	001959010
12x13	2	001959013
14x15	2	001959015
16x18	2	001959018
17x19	2	001959019

374K



L mm		
240	1	003749024

850MQ



1000 V



L mm		
233	1	008500910

855P



L1 mm		
240	1	008550010

860/58K



L mm		
126	1	008609884

860LP



SxA mm		
0,5x3	5	008600005
0,6x4,5	5	008600010
0,8x5,5	5	008600015
1x5,5	5	008600020
1,2x6,5	5	008600025

860PH



PH		
0	5	008600220
1	5	008600225
2	5	008600230
3	5	008600245
4	5	008600250

860PZ



PZ		
1	5	008600320
2	5	008600325
3	5	008600330
4	5	008600335

860PE



mm	5	008600101
2	5	008600101
2,5	5	008600102
3	5	008600103
4	5	008600104
5	5	008600105
6	5	008600106
8	5	008600108
10	5	008600110

860TX



mm	5	008600704
T6	5	008600704
T7	5	008600705
T8	5	008600710
T9	5	008600715
T10	5	008600720
T15	5	008600725
T20	5	008600730
T25	5	008600735
T27	5	008600740
T30	5	008600745
T40	5	008600750

860RTX



mm	5	008600550
T9	5	008600550
T10	5	008600555
T15	5	008600560
T20	5	008600565
T25	5	008600570
T27	5	008600575
T30	5	008600580
T40	5	008600585

860/C27



860/C27	1	008600880
860/C27	1	008600880

860MIX/A10



860MIX/A10	1	008600900
860MIX/A10	1	008600900

860TX/A10



860TX/A10	1	008600970
860TX/A10	1	008600970

860MIX/A31



860MIX/A31	1	008600902
860MIX/A31	1	008600902

862F/A7



862F/A7	1	008620950
862F/A7	1	008620950

900K



mm	10	009009040
4	10	009009040
4,5	10	009009045
5	10	009009050
5,5	10	009009055
6	10	009009060
7	10	009009070
8	10	009009080
9	10	009009090
10	10	009009100
11	10	009009110

mm	10	009009120
12	10	009009120
13	10	009009130
14	10	009009140

900/20LK



L mm	5	009009819
L mm	5	009009819

900/25K



L mm	5	009009830
L mm	5	009009830

900BG/30K



L mm	5	009009834
L mm	5	009009834

900/55K



L mm	5	009009870
L mm	5	009009870

920AK



mm	10	009209010
10	10	009209010
11	10	009209011
12	10	009209012
13	10	009209013
14	10	009209014
15	10	009209015
16	10	009209016
17	10	009209017
18	10	009209018
19	10	009209019
20	5	009209020
21	5	009209021
22	5	009209022
23	5	009209023
24	5	009209024
25	5	009209025
26	5	009209026
27	5	009209027
28	5	009209028
29	5	009209029
30	5	009209030
32	5	009209032

920/21K

12"



L mm	5	009209822
125	5	009209822

920/25K

12"



L mm	5	009209830
75	5	009209830

920/55K

12"



L mm	3	009209882
275	3	009209882

935K



mm	5	
6x7	5	009359105
8x9	5	009359111
10x11	5	009359115
12x13	5	009359117
14x15	5	009359126
16x17	5	009359128
18x19	5	009359131
20x22	3	009359138

937K



mm	5	
6x6	5	009379006
7x7	5	009379007
8x8	5	009379008
9x9	5	009379009
10x10	5	009379010
11x11	5	009379011
12x12	5	009379012
13x13	5	009379013
14x14	5	009379014
15x15	5	009379015
16x16	5	009379016
17x17	5	009379017
18x18	5	009379018
19x19	5	009379019
20x20	5	009379020
21x21	3	009379021
22x22	3	009379022

943BXK



mm	5	
5,5	5	009439005
6	5	009439006
7	5	009439007
8	5	009439008
10	3	009439010
13	3	009439013

951K



mm	5	
2	5	009519521
2,5	5	009519525
3	5	009519530
3,5	5	009519535
4	5	009519540
4,5	5	009519545
5	5	009519550
6	5	009519560
8	5	009519580
10	5	009519610

1032K



L mm	5	
140x0,9	5	010329013
140x1,3	5	010329014
180	5	010329017

1033K



L mm	5	
140x0,9	5	010339013
140x1,3	5	010339014
180	5	010339017

1034K



L mm	5	
130x0,9	5	010349013
130x1,3	5	010349014
170	5	010349017

1036K



L mm	5	
140x0,9	5	010369013
140x1,3	5	010369014
175	5	010369017

1037K



L mm	5	
140x0,9	5	010379013
140x1,3	5	010379014
175	5	010379017

1038K



L mm	5	
135x0,9	5	010389013
135x1,3	5	010389014
175	5	010389017

1044K



L mm	5	
250	5	010449250

1044FK



L mm	5	
250	5	010449015

1046K



L mm	5	
240	5	010469240

1048K



L mm		
175	3	010489010
250	5	010489250

1048VK



L mm		
175	3	010489110
250	5	010489025

1052K



L mm		
140	3	010529014
190	3	010529019
240	3	010529024

1082K



L mm		
140	5	010829004
160	5	010829006

1082BMK



L mm		
140	3	010829034
160	3	010829036

1084K



L mm		
160	3	010849006

1084BMK



L mm		
160	3	010849036

1088K



L mm		
160	2	010889006

1088BMK



L mm		
160	2	010889036

1096K



L mm		
200	5	010969020

1098K



L mm		
190	5	010989190
220	5	010989220

1098PLK



L mm		
220	5	010989320

1112K



L mm		
200	2	011129020

1122K



L mm		
250	2	011229020

1123K



L mm		
250	2	011239020

1124K



L mm		
250	2	011249020

1128BAX



L mm		
150	5	011280088

1128BCX



L mm	5	011280080
155		

1128BMX



L mm	5	011280050
145		

1128BSX



L mm	5	011280060
145		

1129BMK



L mm	5	011299000
145		

1130BMX



L mm	1	011300001
190		

1132K



L	2	011329107
170		

1132BMK



L	2	011329137
170		

1142BMK



L mm	3	011429036
160		

1149F



L mm	1	011490010
175		

1150K



L mm	5	011509006
160		
180	5	011509008
200	5	011509010
220	2	011509012

1150BMK



L mm	3	011509036
160		
180	3	011509038
200	3	011509040
220	2	011509042

1162K



L mm	5	011629006
160		
200	5	011629010

1162BMK



L mm	3	011629036
160		
200	3	011629040

1164K



L mm	5	011649006
160		
200	5	011649010

1164BMK



L mm	3	011649036
160		
200	3	011649040

1166K



L mm	5	011669006
160		
200	5	011669010

1166BMK



L mm	3	011669036
160		
200	3	011669040



1168K



L mm	⚙️	📦
160	5	011689006
200	5	011689010

1168BMK



L mm	⚙️	📦
160	3	011689036
200	3	011689040

1201K



SxAxL mm	⚙️	📦
0,4x2,5x50	5	012019003
0,4x2,5x75	5	012019006
0,5x3x75	5	012019009
0,5x3x100	5	012019012
0,6x3,5x75	5	012019018
0,6x3,5x100	5	012019021
0,8x4x100	5	012019030
0,8x4x125	5	012019033
0,8x4x150	5	012019036
1,0x5,5x100	5	012019039
1,0x5,5x125	5	012019040
1,0x5,5x150	5	012019042
1,2x6,5x100	5	012019048
1,2x6,5x125	5	012019050
1,2x6,5x150	5	012019051
1,2x8x150	3	012019057
1,2x8x200	3	012019060
1,6x10x200	3	012019066

1201NK



SxAxL mm	⚙️	📦
0,8x4x30	3	012019103
1,2x6,5x30	3	012019106

1202K



PHxDxL mm	⚙️	📦
0x3x60	5	012029003
0x3x100	5	012029006
1x4,5x80	5	012029009
2x6x100	5	012029018
3x8x150	3	012029024
1x4,5x120	5	012029012
2x6x150	5	012029021
4x9,5x200	3	012029027

1202NK



PHxDxL mm	⚙️	📦
1x4,5x30	3	012029103
2x6x30	3	012029106

1204K



SxDxL mm	⚙️	📦
0,4x2,5x60	5	012049003
0,6x3x75	5	012049006
0,5x3x100	5	012049009
0,8x4x100	5	012049012
0,8x4x125	5	012049015
1,0x5x125	5	012049018
1,0x5x150	5	012049021
1,2x6,5x150	5	012049024

1207TXK



Type	⚙️	📦
T5	5	012079005
T6	5	012079006
T7	5	012079007
T8	5	012079008
T9	5	012079009
T10	5	012079010
T15	5	012079015
T20	5	012079020
T25	5	012079025
T27	5	012079027
T30	5	012079030
T40	2	012079040
T45	2	012079045

1208RTXK

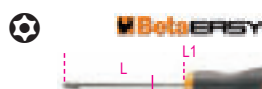

Type	⚙️	📦
T9	5	012089009
T10	5	012089010
T15	5	012089015
T20	5	012089020
T25	5	012089025
T27	5	012089027
T30	5	012089030
T40	2	012089040

1209PZK



PZ	⚙️	📦
0	5	012099000
1	5	012099003
2	5	012099006
3	3	012099009
4	3	012099012

1209N/PZK



Type	⚙️	📦
1	3	012099103
2	3	012099106

1253



SxAxL mm	⚙️	📦
0,5x3,5x100	5	012530001

1254



SxAxL mm	⚙️	📦
0,5x3x44	5	012540001

1260K



SxAxL mm	⚙️	📦
0,4x2,5x50	5	012609003
0,4x2,5x75	5	012609006
0,5x3x75	5	012609009
0,5x3x100	5	012609012
0,6x3,5x75	5	012609018
0,6x3,5x100	5	012609021
0,8x4x100	5	012609030
0,8x4x125	5	012609033
0,8x4x150	5	012609036
1x5,5x100	5	012609039
1x5,5x150	5	012609042
1,5x6,5x100	5	012609048
1,2x6,5x150	5	012609051
1,2x8x150	3	012609057
1,2x8x200	3	012609060
1,6x10x200	3	012609066

1260NK



SxAxL mm	⚙️	📦
0,8x4x30	5	012609103
1,2x6,5x30	5	012609106

1260EK



SxAxL mm	⚙️	📦
1,2x6,5x150	3	012609156
1,2x8x175	3	012609157
1,6x10x200	2	012609159
2x12x250	2	012609162

1262K



PHxDxL mm	⚙️	📦
0x3x60	5	012629003
0x3x100	5	012629006
1x4,5x80	5	012629009
1x4,5x120	5	012629012
2x6x100	5	012629018
2x6x150	5	012629021
3x8x150	3	012629024
4x10x200	3	012629027

1262NK



PHxDxL mm	⚙️	📦
1x4,5x30	5	012629103
2x6x30	5	012629106

1262EK



PHxDxL mm	⚙️	📦
2x6x150	3	012629153
3x8x175	3	012629156
4x10x200	3	012629159

1264K



SxDxL mm	⚙️	📦
0,5x2,5x60	5	012649003
0,6x3x75	5	012649006
0,6x3x100	5	012649009
0,8x4x100	5	012649012
0,8x4x125	5	012649015
1x5x125	5	012649018
1x5x150	5	012649021
1,2x6,5x150	5	012649024

1267TXK



⊖	⚙️	📦
T5	5	012679005
T6	5	012679006
T7	5	012679007
T8	5	012679008
T9	5	012679009
T10	5	012679010
T15	5	012679015
T20	5	012679020
T25	5	012679025
T27	5	012679027
T30	5	012679030
T40	2	012679040
T45	2	012679045

1268RTXK



⊕	⚙️	📦
T9	3	012689009
T10	3	012689010
T15	3	012689015
T20	3	012689020
T25	3	012689025
T27	3	012689027
T30	3	012689030
T40	2	012689040

1269PZK



PZ	⚙️	📦
0	5	012699000
1	5	012699001
2	5	012699002
3	3	012699003
4	3	012699004

1269N/PZK



PZ	⚙️	📦
1	5	012699011
2	5	012699012

1290K



SxAxL mm	⚙️	📦
0,4x2,5x50	5	012909003
0,4x2,5x75	5	012909006
0,5x3x75	10	012909009
0,5x3x100	10	012909012
0,6x3,5x75	10	012909018
0,6x3,5x100	10	012909021
0,8x4x100	10	012909030
0,8x4x125	10	012909033
0,8x4x150	10	012909036
1x5,5x100	10	012909039
1x5,5x150	10	012909042
1,2x6,5x100	10	012909048
1,2x6,5x150	10	012909051
1,2x8x150	3	012909057
1,2x8x200	3	012909060
1,6x10x200	3	012909066

1290NK



SxAxL mm	⚙️	📦
0,8x4x30	5	012909103
1,2x6,5x30	5	012909106

1292K



PHxDxL mm	⚙️	📦
0x3x60	10	012929003
0x3x100	5	012929006
1x4,5x80	10	012929009
1x4,5x120	10	012929012
2x6x100	10	012929018
2x6x150	10	012929021
3x8x150	3	012929024
4x10x200	3	012929027

1292NK



PHxDxL mm	⚙️	📦
1x4,5x30	5	012929103
2x6x30	5	012929106

1294K



SxDxL mm	🔧	📦
0,5x2,5x60	5	012949003
0,6x3x75	5	012949006
0,8x4x100	5	012949012
1x5x125	5	012949018

1298RTXK



⊕	🔧	📦
T9	5	012989009
T10	5	012989010
T15	5	012989015
T20	5	012989020
T25	5	012989025
T27	5	012989027
T30	5	012989030
T40	2	012989040

1299PZK



PZ	🔧	📦
0	5	012999000
1	5	012999003
2	5	012999006

1299N/PZK



PZ	🔧	📦
1	5	012999021
2	5	012999024

1472VW



L mm	🔧	📦
200	1	014720051

1473P



A Max mm	🔧	📦
53	1	014730020

1497RC



1497RC	🔧	📦
	1	014970351

1603K



🔧	mm2	🔧	📦
0	8	5	016039001

1603BK



🔧	mm2	🔧	📦
0	8	2	016039010

1691BM



L m	🔧	📦
5	1	016910205
8	1	016910208
10	1	016910210

1692



L m	🔧	📦
2	5	016920052
3	5	016920053
5	5	016920055
8	5	016920058

1729CG



L mm	🔧	📦
310	2	017290200

1729DM 450



L mm	🔧	📦
450	4	017290450

1741U



Ø mm	2,4	3	3,2	4	4,8
Aluminium	•	•	•	•	•
Steel	•	•	•	•	•
Stainless steel	•	•	•	•	•

1741U	🔧	📦
	1	017410450

Beta

1741B



250 mm



Ø mm	2,4	3,2	4	4,8	5
Aluminium	•	•	•	•	•
Steel	•	•	•	•	•
Stainless steel	•	•	•		

1741B 1 017410000

1760K

CE



180 mm

CAT III-1000V



1760K 1 017600140

1762K



Ø mm
2-2,5-3
3,5-4-4,5

2 017629001

1771



170 mm



1771 10 017710000

1770BM



L



L mm 140 10 017700050

1771BM



L



L mm 170 10 017710050

1772R



L



L mm 125 5 017720006

1773A



L



L mm 180 10 017730000

1777BMT



L



L mm 170 5 017770050

1777T



L



L mm 160 5 017770030

1783



L mm 215 5 017830021
240 5 017830024

1820



L=1,25 m

230V Shuko



1820 30 30W L = 210mm 1 018200003

1820 60 60W L = 220mm 1 018200006

1820 80 80W L = 260mm 1 018200008

1822

CE



230V Shuko

L=1,25 m



1822 120 120W LxA = 250x125 mm 1 018220012

1822 180 180W LxA = 250x125mm 1 018220018

1822 320 320W LxA = 250x140mm 1 018220032

1834PS



L



L mm 150 1 018340310

1834PM



L



L mm 140 1 018340320

1834PL



L



L mm 210 1 018340325



1834PXL



1834PXL

1 018340330

1834RR



1834RR

1 018340520

1836A

CE



1836A

1 018360050

1836B

CE



1836B

1 018360200

1837N



L
mm
450

1 018370002

1838COB

CE



1838COB

1 018380010

1838P

CE



1838P

1 018380005

1838SLR

CE



IP30



1838SLR

1 018380201

1838SN

CE



IP20



1838SN

1 018380132



Beta

Beta SHOP *in Shop*



**DISPLAY UNITS
FOR SALES
POINTS**

BUILD YOUR BETA CORNER
www.beta-tools.com/beta/3d/

38/DS1

wall-mounted display with 75 punches



495x260x332 mm

display with assortment

38/DS1 1 000380701

n.

30	Ø 2 - 3 - 4 - 5 - 6 mm	5
31	Ø 2 - 3 - 4 - 5 - 6 - 8 - 10 mm	5
32	Ø 3 - 4 - 5 mm	5

empty display

38/DVS1 1 000380751

38/DS2

wall-mounted display with 65 chisels

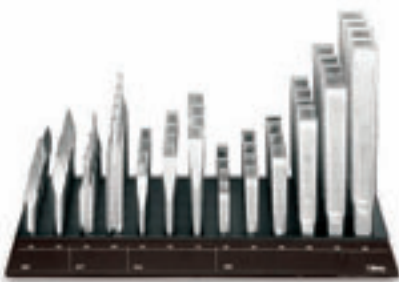

495x260x332 mm

display with assortment

38/DS2 1 000380702

n.

34	125 - 150 - 175 mm	5
35	100 - 125 - 150 - 200 - 250 - 300 mm	5
36	125 - 150 mm	5
37	150 - 200 mm	5

empty display

38/DVS2 1 000380752

942BX/DG

wall-mounted display with 43 hi-torque hexagon nut spinners, short series



330x260x332 mm

display with assortment

942BX/DG 1 009420701

n.

942BX	5 - 5,5 mm	3
	6 - 7 mm	6
	8 - 9 - 10 mm	5
	11 mm	2
	12 mm	3
	13 mm	5

empty display

942BX/DVG 1 009420751

943BX/DG

wall-mounted display with 43 hi-torque hexagon nut spinners, long series



330x260x332 mm

display with assortment

943BX/DG 1 009430701

n.

943BX	5 - 5,5 mm	3
	6 - 7 mm	6
	8 - 9 - 10 mm	5
	11 mm	2
	12 mm	3
	13 mm	5

empty display

943BX/DVG 1 009430751

944BX/DG

wall-mounted display with 43 deep hi-torque hexagon nut spinners with handles, long series



330x260x332 mm

display with assortment

944BX/DG 1 009440701

n.

944BX	5 - 5,5 mm	3
	6 - 7 mm	6
	8 - 9 - 10 mm	5
	11 mm	2
	12 mm	3
	13 mm	5

empty display

944BX/DVG 1 009440751

943MQ/BG

wall-mounted display with 30 hexagon nut spinners



⚠ 1000 V ⚡

330x260x332 mm

display with assortment

943MQ/BG 1 009430281

n.

943MQ	5,5 - 6 - 7 - 8 - 10 - 13 mm	5
-------	------------------------------	---

empty display

943BG-MQ/DV 1 009430285

1203/E1P

wall-mounted display with 82 screwdrivers



495x260x310 mm

display with assortment
1203/E1P 1 012030301

		n.
● 1201	0,4x2,5x50 - 0,5x3x75 - 0,6x3,5x100	7
	0,8x4x100 - 0,8x4x125 mm	
	1,0x5,5x100 - 1,0x5,5x150 - 1,2x6,5x150 mm	6
	1,2x8x150 mm	5
⊕ 1202	PH0x3x60 mm	7
	PH1x4,5x80 - PH2x6x100 mm	6
	PH3x8x150 mm	5

empty display
1203/EV1P 1 012030351

1203/E4P

wall-mounted display with 85 screwdrivers

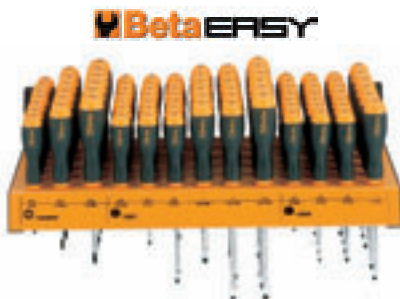

495x260x310 mm

display with assortment
1203/E4P 1 012030304

		n.
● 1201	0,4x2,5x50 - 0,5x3x75 - 0,8x4x125 mm	7
	1,0x5,5x100 - 1,0x5,5x150 - 1,2x6,5x150 mm	6
	● 1204	0,4x2,5x60 - 0,5x3x100 - 0,8x4x100 mm
	1,0x5x125 mm	6
⊕ 1209PZ	PZ0x3x60 mm	7
	PZ1x4,5x80 - PZ2x6x100 mm	6

empty display
1203/EV4P 1 012030354

1203/E5P

wall-mounted display with 82 screwdrivers



495x260x310 mm

display with assortment
1203/E5P 1 012030305

		n.
⊕ 1202	PH0x3x60 mm	7
	PH1x4,5x80 - PH1x4,5x120	6
	PH2x6x100 - PH2x6x150 mm	
	PH3x8x150 mm	5
● 1204	0,4x2,5x60 - 0,5x3x100 - 0,8x4x100 mm	7
	1,0x5x125 mm	6
	⊕ 1209PZ	PZ0x3x60 mm
	PZ1x4,5x80 - PZ2x6x100 mm	6

empty display
1203/EV5P 1 012030355

1203/E10P

wall-mounted display with 80 screwdrivers



495x260x310 mm

display with assortment
1203/E10P 1 012030310

		n.
⊕ 1207TX	T6	4
	T7	3
	T8	7
	T9 - T10 - T15 - T20 - T25	6
	T27 - T30	3
⊕ 1208TX	T9 - T10	3
	T15 - T20 - T25	6
	T27 - T30	3

empty display
1203/EV10P 1 012030360

1263/E78

wall-mounted display with 78 screwdrivers



display with assortment
1263/E78 1 012630510

		n.
● 1260	2,5x75-3x75-3,5x100 mm	7
	⊕ 1262	PH0x60 mm
	4x100-4x125-5,5x100-5,5x150-6,5x150 mm	6
	8x150 mm	4
	PH1x80-PH2x100 mm	6
	PH3x150	4

empty display
1263/EV78 1 012630511

1263/E85

wall-mounted display with 85 screwdrivers



495x260x377 mm

display with assortment
1263/E85 1 012630550

		n.
● 1260	2,5x50 mm	7
	2,5x75 mm	6
	3x75 - 3x100 - 3,5x100 mm	7
	4x100 - 4x125 - 5,5x125	6
	5,5x150 - 6,5x150 mm	6
	8x150 mm	4
● 1260E	10x200 mm	3
	12x250 mm	2
● 1260N	4x30 - 6,5x30 mm	6

empty display
1263/EV85 1 012630551

1263/E70

wall-mounted display
with 70 screwdrivers



495x260x327 mm

display
with assortment
1263/E70

1 012630560

		n.	
+	1262	PH0x60 - PH0x100 mm	7
		PH1x80 - PH1x120 mm	6
		PH2x100 mm	9
		PH2x150 - PH3x150 mm	5
		PH4x200 mm	4
+	1262E	PH2x150 mm	5
		PH3x175 mm	4
+	1262N	PH1x30 - PH2x30 mm	6

empty
display
1263/EV70

1 012630561

1263/E50

wall-mounted display
with 50 screwdrivers



330x260x269 mm

display
with assortment
1263/E50

1 012630570

		n.	
●	1264	2,5x60 - 3x75 - 3x100 mm	7
		4x100 - 4x125 - 5x125 - 5x150 mm	6
		6,5x150 mm	5

empty
display
1263/EV50

1 012630571

1263/E62

wall-mounted display
with 62 screwdrivers



495x260x257 mm

display
with assortment
1263/E62

1 012630590

		n.	
⊕	1267TX	T5	5
		T6	6
		T7	5
		T8	6
		T9	5
		T10 - T15 - T20	6
		T25	5
		T27 - T30	4
		T40 - T45	2

empty
display
1263/EV62

1 012630591

1263/E39

wall-mounted display
with 39 screwdrivers



330x260x257 mm

display
with assortment
1263/E39

1 012630595

		n.	
⊕	1268RTX	T9x60 - T10x80 - T15x80 T20x100 - T25x100 mm	6
		T27x115 mm	4
		T30x115 mm	3
		T40x130 mm	2

empty
display
1263/EV39

1 012630596

1263/E40

wall-mounted display
with 40 screwdrivers



330x260x327 mm

display
with assortment
1263/E40

1 012630580

		n.	
+	1269	PZ0x60 mm	7
		PZ1x80 mm	6
		PZ2x100 - PZ3x150 - PZ4x200 mm	5
+	1269N	PZ1x30 - PZ2x30 mm	6

empty
display
1263/EV40

1 012630581

1273MQ/E1

wall-mounted display with 40 screwdrivers

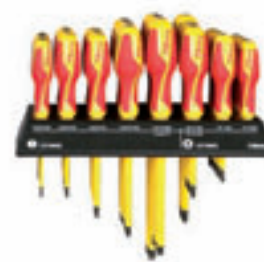

⚠ 1000 V

330x260x332 mm

display
with assortment
1273MQ/E1

1 012730312

		n.	
+	1272MQ	PH0x60 - PH1x80 mm	5
		PH2x100 mm	3
		PH3x150 mm	2
●	1274MQ	3x100 - 4x100 - 5,5x125 - 6,5x150 mm	5
		8x175 mm	3
		10x200 mm	2

empty
display
1273BG-MQ/DV

1 012730651

1293BX/DA

wall-mounted display with 90 screwdrivers



495x260x332 mm

display with assortment
1293BX/DA 1 012930701

		n.
1290	3x75 - 3,5x100 - 4x100 - 4x125 5,5x100 - 5,5x150 mm 6,5x150 mm	7 6 6
	8x150 mm	3
	10x200 mm	2
1290N	4x30 - 6,5x30 mm	3
1292	PH0x60 - PH1x80 mm PH2x100 mm PH3x150 mm	7 6 5
1292N	PH1x30 - PH2x30 mm	3

empty display
1293BX/DVA 1 012930751

1293BX/DD

wall-mounted display with 48 screwdrivers



330x260x332 mm

display with assortment
1293BX/DD 1 012930704

		n.
1294	2,5x60 - 3x75 - 3x100 - 4x100 4x150 - 5x125 mm 6,5x150 mm	7 6 6

empty display
1293BX/DVD 1 012930754

1293BX/DE

wall-mounted display with 42 screwdrivers



330x260x332 mm

display with assortment
1293BX/DE 1 012930705

		n.
1299PZ	PZ0x60 - PZ1x80 mm PZ2x100 mm PZ3x150 - PZ4x200 mm	7 6 5
1299N/PZ	PZ1x30 - PZ2x30 mm	6

empty display
1293BX/DVE 1 012930755

1293BX/DF

wall-mounted display with 59 screwdrivers



330x260x332 mm

display with assortment
1293BX/DF 1 012930706

		n.
1297TX	T6 - T8 - T10 - T15 - T20 - T25 T27 - T30 T40	7 6 5

empty display
1293BX/DVF 1 012930756

C68

Beta wall display, empty



1000x560x2200 mm

		n.
C68/1	1 m	1 068000001
C68/2	2 m	1 068000002
C68/3	3 m	1 068000003
C68/4	4 m	1 068000004
C68/5	5 m	1 068000005
C68/6	6 m	1 068000006
C68/7	7 m	1 068000007
C68/8	8 m	1 068000008
C68/9	9 m	1 068000009
C68/10	10 m	1 068000010

C68 G

"gondola" display



1000x1120x1600 mm

		n.
C68G/1	1 m	1 068000051
C68G/2	2 m	1 068000052
C68G/3	3 m	1 068000053
C68G/4	4 m	1 068000054

C88 R/1

Robur wall display, empty



1000x560x2200 mm

C88R/1 1 m 1 088000001

C88VE

display tray for display walls C88

suitable for housing coils of chains item 8120



C88VE 1 088000120

C88SE

display tray for Genovese chain reels



C88SE 1 088000130

1700x600x600 mm

6888

hooks for displays C60 - C61 - C68 - C88



6888S1	10	068880011
6888S2	10	068880012
6888D1	5	068880021
6888D2	5	068880022
6888D4	5	068880024
6888D5	5	068880025
6888T1	5	068880031
6888T2	5	068880032
6888CT	1	068880044

6800 VE

showcase for wall displays C68 and C68 R/1



6800VE/1	1 m	1	068000401
6800VE/2	2 m	1	068000402
6800VE/3	3 m	1	068000403
6800VE/4	4 m	1	068000404
6800VE/5	5 m	1	068000405

ACCESSORIES

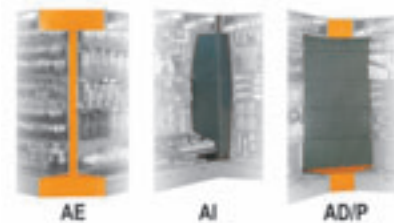

6800AE	1	068000145
6800AI	1	068000140
6800AD/P	1	068000143

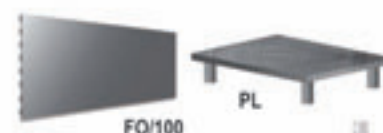
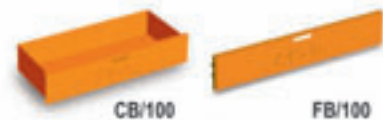

6800CB/100	1	068000104
6800FB/100	1	068000109
6800FO/100	1	068000108
6800PL	1	068000137
6800RP/100	1	068000150
6800GR/37	1	068000159

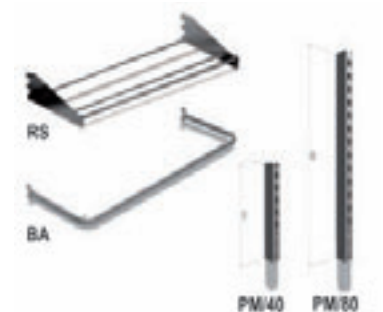

6800BA	1	068000130
6800RS	1	068000135
6800PM/40	1	068000171
6800PM/80	1	068000172

6600 M/11

assortment of 154 tools, with hooks without panel





6600 M/11 1 066000011



6600 M/22

assortment of 108 tools,
with hooks without panel





6600 M/22   1 066000022

6600 M/27

assortment of 25 tools,
with hooks without panel





6600 M/27   1 066000027

6600 M/38

assortment of 107 tools
with hooks without panel





6600 M/38   1 066000038

6600 M/39

assortment of 77 tools,
with hooks without panel





6600 M/39   1 066000039

6600 M/40

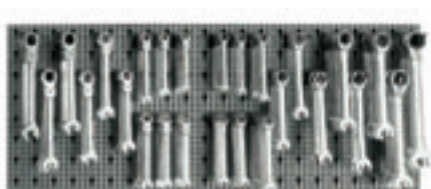
assortment of 100 tools,
with hooks without panel





6600 M/40   1 066000040

6600 M/47

assortment of 65 tools,
with hooks without panel



6600 M/47   1 066000047

6600 M/51

assortment of 257 tools
with hooks without panel





6600 M/51   1 066000051

6600 M/52

assortment of 176 tools
with hooks without panel





6600 M/52   1 066000052

6600 M/58

assortment of 150 tools
with hooks without panel





6600 M/58   1 066000058

6600 M/61

assortment of 71 tools,
with hooks without panel



6600 M/61   1 066000061

6600 M/63

assortment of 110 tools
with hooks without panel



6600 M/63   1 066000063

6600 M/73

assortment of 68 tools
with hooks without panel



6600 M/73   1 066000073

6600 M/112

assortment of 329 tools,
with hooks without panel



6600 M/112

1 066000112

6600 M/116

assortment of 306 tools,
with hooks without panel



6600 M/116

1 066000116

6600 M/120

assortment of 163 tools,
with hooks without panel

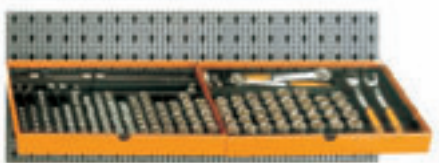

6600 M/120

1 066000120

6600 M/125

assortment of 133 tools,
with hooks without panel

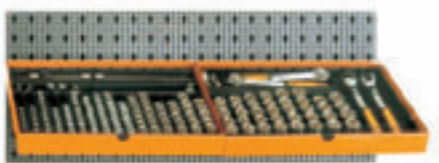

6600 M/125

1 066000125

6600 M/126

assortment of 58 tools,
with hooks without panel



6600 M/126

1 066000126

6600 M/131

assortment of 92 tools,
with hooks without panel



6600 M/131

1 066000131

6600 M/173

assortment of 13 tools,
with hooks without panel



6600M/173

1 066000173

6600 M/216

assortment of 80 tools,
with hooks without panel

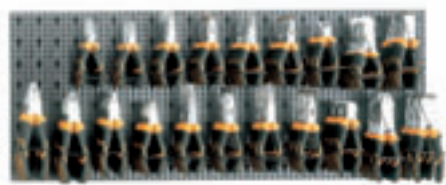

6600 M/216

1 066000216

6600 M/221

assortment of 83 tools
with hooks without panel

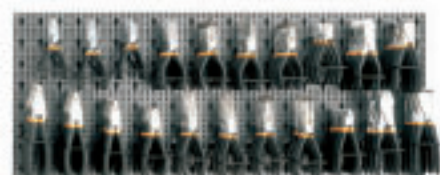

6600 M/221

1 066000221

6600 M/230

assortment of 78 tools,
with hooks without panel



6600 M/230

1 066000230

6600 M/234

assortment of 31 tools
with hooks without panel



6600 M/234

1 066000234

6600 M/241

assortment of 43 tools,
with hooks without panel





6600 M/241

1 066000241

6600 M/244

assortment of 91 tools
with hooks without panel





6600 M/244   1 066000244

6600 M/311

assortment of 114 tools,
with hooks without panel





6600 M/311   1 066000311

6600 M/315

assortment of 149 tools,
with hooks without panel





6600 M/315   1 066000315

6600 M/320

assortment of 98 tools,
with hooks without panel





6600 M/320   1 066000320

6600 M/326

assortment of 155 tools,
with hooks without panel





6600 M/326   1 066000326

6600 M/327

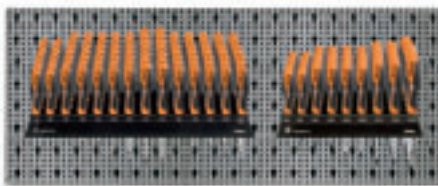
assortment of 101 tools,
with hooks without panel





6600 M/327   1 066000327

6600 M/330

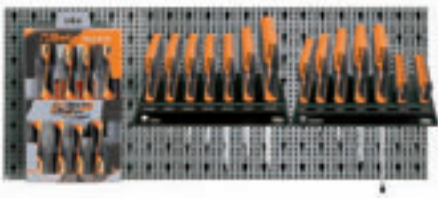
assortment of 110 tools,
with hooks without panel





6600 M/330   1 066000330

6600 M/370

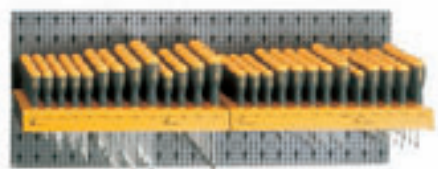
assortment of 162 tools,
with hooks without panel





6600 M/370   1 066000370

6600 M/378

assortment of 73 tools
with hooks without panel





6600 M/378   1 066000378

6600 M/417

assortment of 43 tools, with hooks without
panel





6600 M/417   1 066000417

6600 M/418

assortment of 35 tools,
with hooks without panel





6600 M/418   1 066000418

6600 M/427

assortment of 24 tools,
with hooks without panel



6600 M/427   1 066000427

6600 M/430

assortment of 29 tools,
with hooks without panel



6600 M/430

1 066000430

6600 M/480

assortment of 18 tools,
with hooks without panel



6600 M/480

1 066000480

6600 M/532

assortment of 24 tools
with hooks without panel



6600 M/532

1 066000532

6600 M/440

assortment of 140 tools,
with hooks without panel

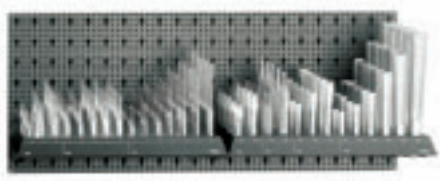

6600 M/440

1 066000440

6600 M/485

assortment of 12 tools,
with hooks without panel



6600 M/485

1 066000485

6600 M/542

assortment of 53 tools,
with hooks without panel



6600 M/542

1 066000542

6600 M/456

assortment of 41 tools,
with hooks without panel



6600 M/456

1 066000456

6600 M/510

assortment of 16 tools,
with hooks without panel



6600 M/510

1 066000510

6600 M/561

assortment of 60 tools,
with hooks without panel

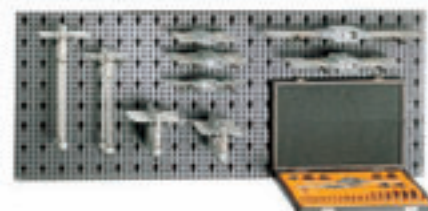

6600 M/561

1 066000561

6600 M/464

assortment of 36 tools,
with hooks without panel



6600 M/464

1 066000464

6600 M/528

assortment of 60 tools,
with hooks without panel



6600 M/528

1 066000528

6600 M/583

assortment of 22 tools
with hooks without panel



6600 M/583

1 066000583

6600 M/609

assortment of 67 tools,
with hooks without panel



6600M/609 1 066000609

6600 M/637

assortment of 87 tools,
with hooks without panel



6600 M/637 1 066000637

6600 M/650

assortment of 28 tools,
with hooks without panel



6600 M/650 1 066000650

6600 M/657

assortment of 17 tools,
with hooks without panel



6600 M/657 1 066000657

6600 M/658

assortment of 14 tools
with hooks without panel



6600 M/658 1 066000658

6600 M/715

assortment of 63 tools,
with hooks without panel



6600 M/715 1 066000715

6600 M/814

assortment of 58 tools,
with hooks without panel



6600 M/814 1 066000814

6600 M/840

assortment of 36 tools,
with hooks without panel



6600 M/840 1 066000840

6600 M/841

assortment of 20 tools,
with hooks without panel



6600 M/841 1 066000841



8600 R/10

assortment of 672 wire rope accessories,
with hanging hooks without panel

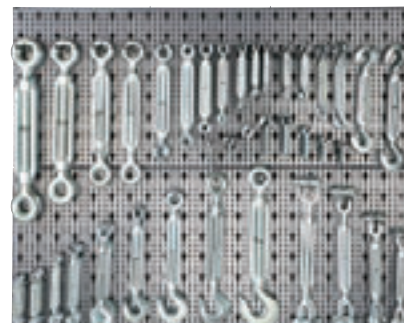

8600 R/10 1 086000010



8600 R/112

assortment of 1942 wire rope accessories,
with hanging hooks without panel



8600 R/112

1 086000112

8600 R/224

assortment of 61 wire rope accessories,
with hooks without panel



8600 R/224

1 086000224

8600 R/411

assortment of 551 wire rope accessories,
STAINLESS STEEL,
with hooks without panel



8600 R/411

1 086000411

8600 R/514

assortment of 14 Genovese chain reels
with display tray



8600 R/514

1 086000514



8600 E/R

assortment of 3226 wire rope accessories,
with hooks without display stand



8600E/R

1 086000917

6600 E/A10

assortment of 605 tools
with hooks without display stand



6600 E/A10

1 066000912

6600 E/A20

assortment of 917 tools
with hooks without display stand



6600 E/A20

1 066000913

6600 E/A30

assortment of 723 tools
with hooks without display stand



6600 E/A30

1 066000924

6600 E/B10

assortment of 596 tools
with hooks without display stand



6600 E/B10

1 066000925

6600 E/C10

assortment of 309 tools
with hooks without display stand



6600 E/C10

1 066000929

6600 E/B20

assortment of 601 tools
with hooks without display stand



6600 E/B20

1 066000926

6600 E/K20

assortment of 386 tools
with hooks without display stand



6600 E/K20

1 066000984



SAFETY FOOTWEAR

Over the years the safety footwear line has gained the most demanding professionals' confidence and preference. These products have been proving so successful as to result in a regularly upgraded and expanded range.

SAFETY STANDARDS

HOW TO CHOOSE SAFETY FOOTWEAR

Make sure that the footwear matches the required protection class, according to type and workplace. Below you will find the European reference standards, including any and all additional specifications.

EN ISO 20344: Test methods and general requirements.

EN ISO 20345: Safety footwear with toe caps resistant to shocks up to 200 Joules.

EN ISO 20346: Protective footwear with toe caps resistant to shocks up to 100 Joules.

EN ISO 20347: Occupational footwear, no toe caps required.

EN ISO 20345 The footwear that complies with this norm is marked with the letter "S" (Safety). The letter "S" is followed by letters and/or numbers indicating the protection class the footwear belongs to.

SB Minimum requirements: 200 Joule toe cap.

Upper made from split leather or the like.

Minimum upper height.

S1 SB characteristics supplemented with the following:

Antistatic footwear (A).

Energy absorption in the heel region (E).

Closed back. (Low shoes as well)

Antislip UNI EN ISO 20345. Method in accordance with EN 13287

S2 S1 characteristics supplemented with the following:

Waterproof upper, no water penetration for at least 1h (WRU).

S3 S2 characteristics supplemented with the following:

Penetration proof insole or inset (P).

Gripped outsole.

S4 S1 characteristics supplemented with the following:

Hydrocarbon proof outsole (ORO).

S5 S4 characteristics supplemented with the following:

Penetration proof insole or inset (P).

Gripped outsole.

EN ISO 20346 These shoes are basically the same as safety footwear. However, since they have 100 Joule toe caps, they are marked with the letter "P" (Protective). Hence they are defined as protective footwear. They are used in workplace environments requiring no more than 100 Joule operation.

EN ISO 20347 These shoes do not have any protective toe caps and are marked with the letter "O" (Occupational); hence they are considered occupational footwear.

To make it easier to identify both the specifications and the details that suit you best, read the section and icons below.



Penetration proof midsole or inset



Steel, aluminium or plastic toe cap



Antistatic footwear



Energy absorption in the heel region



Oil, hydrocarbon and solvent proof outsole



Antislip outsole



Flexing resistance >60,000



Outsole resistant to hot contact (300 °C/min.)



Shoe with a wide body for enhanced comfort



Nonmagnetic shoe, totally free from metal parts



Shoe designed and developed to allow electrostatic charges to be steadily dissipated from the body to the ground



Shoe designed and developed to provide cold insulation (CI)

WARNINGS

PRELIMINARY CHECKS AND USE

Before using the shoes, visually check their general state – that is, the seams, the sole and the closures –; also make sure that the shoes match all the specifications on the label, and, above all, that they are provided with steel toes and penetration proof steel midsoles.

MISUSE

Prolonged and/or repeated use:

- in contact with organic agents, herbicides, pesticides and highly concentrated acids

- at very low or very high temperatures (below -10 °C and over $+70\text{ °C}$)
- fully dipped into water, mud, mortar and alike is not recommended.

BASIC



7241B

leather shoe, with penetration proof insole

- Steel toe cap
- Elastic steel penetration proof insole

EU	UK	1	072410235
35	2,5	1	072410235
36	3,5	1	072410236
37	4,5	1	072410237
38	5	1	072410238
39	6	1	072410239
40	6,5	1	072410240
41	7	1	072410241
42	8	1	072410242
43	9	1	072410243
44	10	1	072410244
45	10,5	1	072410245
46	11	1	072410246
47	12	1	072410247
48	13	1	072410248



CE

S1P SRC

EN ISO
20345
2011



7241C

leather shoe, waterproof,
with penetration proof insole

- Steel toe cap
- Elastic steel penetration proof insole

EU	UK	1	072410535
35	2,5	1	072410535
36	3,5	1	072410536
37	4,5	1	072410537
38	5	1	072410538
39	6	1	072410539
40	6,5	1	072410540
41	7	1	072410541
42	8	1	072410542
43	9	1	072410543
44	10	1	072410544
45	10,5	1	072410545
46	11	1	072410546
47	12	1	072410547
48	13	1	072410548



CE

S3 SRC

EN ISO
20345
2011



7241FT

leather shoe, waterproof,
without toe cap and penetration proof insole

- Without toe cap
- Without penetration proof insole

EU	UK	1	072410635
35	2,5	1	072410635
36	3,5	1	072410636
37	4,5	1	072410637
38	5	1	072410638
39	6	1	072410639
40	6,5	1	072410640
41	7	1	072410641
42	8	1	072410642
43	9	1	072410643
44	10	1	072410644
45	10,5	1	072410645
46	11	1	072410646
47	12	1	072410647
48	13	1	072410648



CE

O2 FO SRC

EN ISO
20347
2012



7243B

leather ankle shoe, with penetration proof insole

- Steel toe cap
- Elastic steel penetration proof insole

EU	UK	Icon	Code
35	2,5		1 072430235
36	3,5		1 072430236
37	4,5		1 072430237
38	5		1 072430238
39	6		1 072430239
40	6,5		1 072430240
41	7		1 072430241
42	8		1 072430242
43	9		1 072430243
44	10		1 072430244
45	10,5		1 072430245
46	11		1 072430246
47	12		1 072430247
48	13		1 072430248



CE

S1P SRC



7243C

leather ankle shoe, waterproof, with penetration proof insole and quick opening system

- Steel toe cap
- Elastic steel penetration proof insole

EU	UK	Icon	Code
35	2,5		1 072430335
36	3,5		1 072430336
37	4,5		1 072430337
38	5		1 072430338
39	6		1 072430339
40	6,5		1 072430340
41	7		1 072430341
42	8		1 072430342
43	9		1 072430343
44	10		1 072430344
45	10,5		1 072430345
46	11		1 072430346
47	12		1 072430347
48	13		1 072430348



CE

S3 RS SRC

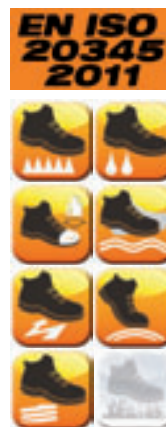

7243CR

leather ankle shoe, waterproof, with durable rubber outsole and quick opening system

- Steel toe cap
- Elastic steel penetration-proof insole

EU	UK	Icon	Code
35	2,5		1 072430735
36	3,5		1 072430736
37	4,5		1 072430737
38	5		1 072430738
39	6		1 072430739
40	6,5		1 072430740
41	7		1 072430741
42	8		1 072430742
43	9		1 072430743
44	10		1 072430744
45	10,5		1 072430745
46	11		1 072430746
47	12		1 072430747
48	13		1 072430748



CE

S3 RS HRO SRC



7243FT

leather ankle shoe, waterproof, without toe cap and penetration proof insole

- Without toe cap
- Without penetration proof insole

EU	UK	Icon	Code
35	2,5		1 072430635
36	3,5		1 072430636
37	4,5		1 072430637
38	5		1 072430638
39	6		1 072430639
40	6,5		1 072430640
41	7		1 072430641
42	8		1 072430642
43	9		1 072430643
44	10		1 072430644
45	10,5		1 072430645
46	11		1 072430646
47	12		1 072430647
48	13		1 072430648



CE

O2 FO SRC



7245B

lace-up full-grain leather shoe, "welder" style, waterproof, with quick opening system and front protection with strap closure

- Steel toe cap
- Elastic steel penetration proof insole

EU	UK		
35	2,5	1	072450235
36	3,5	1	072450236
37	4,5	1	072450237
38	5	1	072450238
39	6	1	072450239
40	6,5	1	072450240
41	7	1	072450241
42	8	1	072450242
43	9	1	072450243
44	10	1	072450244
45	10,5	1	072450245
46	11	1	072450246
47	12	1	072450247
48	13	1	072450248



CE

S3 RS SRC



7246B

suede shoe, perforated

- Steel toe cap
- Elastic steel penetration proof insole

EU	UK		
35	2,5	1	072460235
36	3,5	1	072460236
37	4,5	1	072460237
38	5	1	072460238
39	6	1	072460239
40	6,5	1	072460240
41	7	1	072460241
42	8	1	072460242
43	9	1	072460243
44	10	1	072460244
45	10,5	1	072460245
46	11	1	072460246
47	12	1	072460247
48	13	1	072460248



CE

S1P SRC

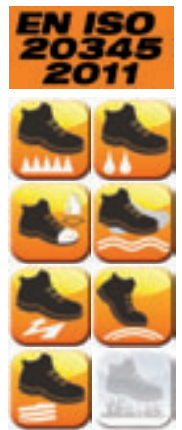

7247B

leather sandal, perforated

- Steel toe cap
- Elastic steel penetration proof insole

EU	UK		
35	2,5	1	072470235
36	3,5	1	072470236
37	4,5	1	072470237
38	5	1	072470238
39	6	1	072470239
40	6,5	1	072470240
41	7	1	072470241
42	8	1	072470242
43	9	1	072470243
44	10	1	072470244
45	10,5	1	072470245
46	11	1	072470246
47	12	1	072470247
48	13	1	072470248



CE

S1P SRC



7328EA

safety boot, "Top Visibility"

- Steel toe cap
- Stainless steel penetration proof insole

EU	UK		
38	5	1	073280538
39	6	1	073280539
40	6,5	1	073280540
41	7	1	073280541
42	8	1	073280542
43	9	1	073280543
44	10	1	073280544
45	10,5	1	073280545
46	11	1	073280546
47	12	1	073280547



CE

S5 SRC

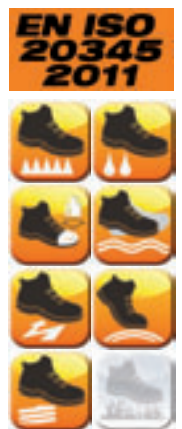

7328EN
safety boot

- Steel toe cap
- Stainless steel penetration proof insole

EU	UK		
38	5	1	073280738
39	6	1	073280739
40	6,5	1	073280740
41	7	1	073280741
42	8	1	073280742
43	9	1	073280743
44	10	1	073280744
45	10,5	1	073280745
46	11	1	073280746
47	12	1	073280747

CE



S5 SRC

**EN ISO
20345
2011**



EASY PLUS

7220PE

leather shoe, waterproof, with nylon inserts, reinforcement polyurethane toe cap cover and refractive heel insert

- Steel toe cap
- Composite fibre penetration proof insole

EU	UK		
35	2,5	1	072200135
36	3,5	1	072200136
37	4,5	1	072200137
38	5	1	072200138
39	6	1	072200139
40	6,5	1	072200140
41	7	1	072200141
42	8	1	072200142
43	9	1	072200143
44	10	1	072200144
45	10,5	1	072200145
46	11	1	072200146
47	12	1	072200147
48	13	1	072200148

CE



S3 SRC

**EN ISO
20345
2011**



7221PE

leather ankle shoe, waterproof, with nylon inserts, quick opening system, reinforcement polyurethane toe cap cover and refractive heel insert

- Steel toe cap
- Composite fibre penetration proof insole

EU	UK		
35	2,5	1	072210135
36	3,5	1	072210136
37	4,5	1	072210137
38	5	1	072210138
39	6	1	072210139
40	6,5	1	072210140
41	7	1	072210141
42	8	1	072210142
43	9	1	072210143
44	10	1	072210144
45	10,5	1	072210145
46	11	1	072210146
47	12	1	072210147
48	13	1	072210148

CE



S3 RS SRC

**EN ISO
20345
2011**



7224PE

suede shoe, perforated, with nylon inserts, reinforcement polyurethane toe cap cover and refractive heel insert

- Steel toe cap
- Composite fibre penetration proof insole

EU	UK		
35	2,5	1	072240135
36	3,5	1	072240136
37	4,5	1	072240137
38	5	1	072240138
39	6	1	072240139
40	6,5	1	072240140
41	7	1	072240141
42	8	1	072240142
43	9	1	072240143
44	10	1	072240144
45	10,5	1	072240145
46	11	1	072240146
47	12	1	072240147
48	13	1	072240148

CE



Jarama

S1P SRC



FLEX



7212FG

suede shoe, perforated, with anti-abrasion insert in toe cap area
Extremely flexible and lightweight - approximate weight, size 42: 450 g
Not recommended for heavy-duty use (building, agriculture, heavy industry)

- Composite toe cap
- Composite fibre penetration-proof insole

EU	UK		
35	2,5	1	072120035
36	3,5	1	072120036
37	4,5	1	072120037
38	5	1	072120038
39	6	1	072120039
40	6,5	1	072120040
41	7	1	072120041
42	8	1	072120042
43	9	1	072120043
44	10	1	072120044
45	10,5	1	072120045
46	11	1	072120046
47	12	1	072120047
48	13	1	072120048

CE



FLEX

S1P SRC

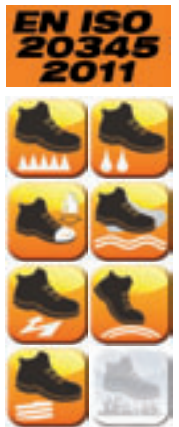

7213FG

suede shoe with highly breathable mesh inserts
Extremely flexible and lightweight - approximate weight, size 42: 450 g
Not recommended for heavy-duty use (building, agriculture, heavy industry)

- Composite toe cap
- Composite fibre penetration-proof insole

EU	UK		
35	2,5	1	072130035
36	3,5	1	072130036
37	4,5	1	072130037
38	5	1	072130038
39	6	1	072130039
40	6,5	1	072130040
41	7	1	072130041
42	8	1	072130042
43	9	1	072130043
44	10	1	072130044
45	10,5	1	072130045
46	11	1	072130046
47	12	1	072130047
48	13	1	072130048

CE



FLEX

S1P SRC

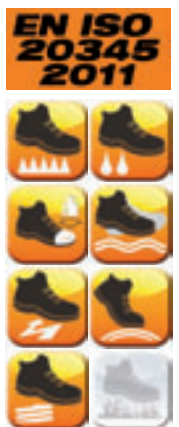

7214FN

Action nubuck shoe, waterproof,
with anti-abrasion insert in toe cap area

Extremely flexible and lightweight - approximate weight size 42: 470 g
Not recommended for heavy-duty use (building, agriculture, heavy industry)

EU	UK		
35	2,5	1	072140035
36	3,5	1	072140036
37	4,5	1	072140037
38	5	1	072140038
39	6	1	072140039
40	6,5	1	072140040
41	7	1	072140041
42	8	1	072140042
43	9	1	072140043
44	10	1	072140044
45	10,5	1	072140045
46	11	1	072140046
47	12	1	072140047
48	13	1	072140048

- Composite toe cap
- Composite fibre penetration-proof insole



EN ISO
20345
2011



CE

S3 SRC

7215FN

Action nubuck moccasin, waterproof,
with anti-abrasion insert in toe cap area

Extremely flexible and lightweight - approximate weight, size
42: 470 g

Not recommended for heavy-duty use (building, agriculture,
heavy industry)

EU	UK		
35	2,5	1	072150135
36	3,5	1	072150136
37	4,5	1	072150137
38	5	1	072150138
39	6	1	072150139
40	6,5	1	072150140
41	7	1	072150141
42	8	1	072150142
43	9	1	072150143
44	10	1	072150144
45	10,5	1	072150145
46	11	1	072150146
47	12	1	072150147
48	13	1	072150148

- Composite toe cap
- Composite fibre penetration-proof insole



EN ISO
20345
2011



CE

S3 SRC

BASIC PLUS



7200BKK

full-grain leather shoe, waterproof

EU	UK		
35	2,5	1	072000235
36	3,5	1	072000236
37	4,5	1	072000237
38	5	1	072000238
39	6	1	072000239
40	6,5	1	072000240
41	7	1	072000241
42	8	1	072000242
43	9	1	072000243
44	10	1	072000244
45	10,5	1	072000245
46	11	1	072000246
47	12	1	072000247
48	13	1	072000248

- Composite toe cap
- Composite fibre penetration proof insole



EN ISO
20345
2011



CE

S3 SRC

7200PN

full-grain leather shoe, waterproof, with waterproof suede inserts

- Composite toe cap
- Composite fibre penetration proof insole

EU	UK		
35	2,5	1	072000535
36	3,5	1	072000536
37	4,5	1	072000537
38	5	1	072000538
39	6	1	072000539
40	6,5	1	072000540
41	7	1	072000541
42	8	1	072000542
43	9	1	072000543
44	10	1	072000544
45	10,5	1	072000545
46	11	1	072000546
47	12	1	072000547
48	13	1	072000548



Imola



CE

S3 SRC

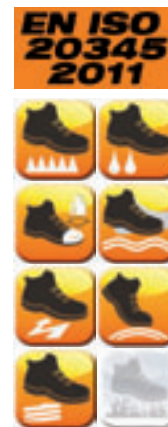

7201BKK

full-grain leather ankle shoe, waterproof

- Composite toe cap
- Composite fibre penetration proof insole

EU	UK		
35	2,5	1	072010435
36	3,5	1	072010436
37	4,5	1	072010437
38	5	1	072010438
39	6	1	072010439
40	6,5	1	072010440
41	7	1	072010441
42	8	1	072010442
43	9	1	072010443
44	10	1	072010444
45	10,5	1	072010445
46	11	1	072010446
47	12	1	072010447
48	13	1	072010448



CE

S3 SRC

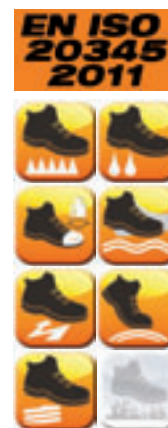

7201PN

full-grain leather ankle shoe, waterproof, with waterproof suede inserts
Quick double-clip opening system

- Composite toe cap
- Composite fibre penetration proof insole

EU	UK		
35	2,5	1	072010535
36	3,5	1	072010536
37	4,5	1	072010537
38	5	1	072010538
39	6	1	072010539
40	6,5	1	072010540
41	7	1	072010541
42	8	1	072010542
43	9	1	072010543
44	10	1	072010544
45	10,5	1	072010545
46	11	1	072010546
47	12	1	072010547
48	13	1	072010548



Imola



CE

S3 RS SRC

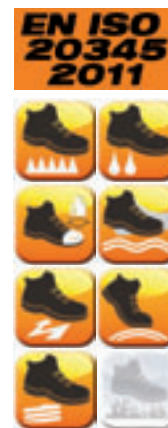

7208WR

full-grain leather ankle shoe, waterproof, with durable rubber outsole and quick opening system.
WR (water resistant footwear) - after 100 steps in a tank with 3 cm of water, the wet internal surface has to be ≤ 3 cm² (spot)

- Composite toe cap
- Composite fibre penetration-proof insole

EU	UK		
38	5	1	072080238
39	6	1	072080239
40	6,5	1	072080240
41	7	1	072080241
42	8	1	072080242
43	9	1	072080243
44	10	1	072080244
45	10,5	1	072080245
46	11	1	072080246
47	12	1	072080247



Trial

CE

S3 RS WR HRO SRC

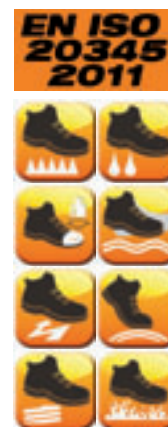

7210BKK

soft suede shoe, perforated

- Composite toe cap
- Composite fibre penetration proof insole

EU	UK		
35	2,5	1	072100335
36	3,5	1	072100336
37	4,5	1	072100337
38	5	1	072100338
39	6	1	072100339
40	6,5	1	072100340
41	7	1	072100341
42	8	1	072100342
43	9	1	072100343
44	10	1	072100344
45	10,5	1	072100345
46	11	1	072100346
47	12	1	072100347
48	13	1	072100348



CE

S1P SRC

EN ISO 20345 2011



7210PB

suede shoe, perforated

- Composite toe cap
- Composite fibre penetration proof insole

EU	UK		
35	2,5	1	072100435
36	3,5	1	072100436
37	4,5	1	072100437
38	5	1	072100438
39	6	1	072100439
40	6,5	1	072100440
41	7	1	072100441
42	8	1	072100442
43	9	1	072100443
44	10	1	072100444
45	10,5	1	072100445
46	11	1	072100446
47	12	1	072100447
48	13	1	072100448



CE

S1P SRC

EN ISO 20345 2011



7211PG

suede shoe, perforated

- Composite toe cap
- Composite fibre penetration proof insole

EU	UK		
35	2,5	1	072110435
36	3,5	1	072110436
37	4,5	1	072110437
38	5	1	072110438
39	6	1	072110439
40	6,5	1	072110440
41	7	1	072110441
42	8	1	072110442
43	9	1	072110443
44	10	1	072110444
45	10,5	1	072110445
46	11	1	072110446
47	12	1	072110447
48	13	1	072110448



CE

S1P SRC

EN ISO 20345 2011



7216BKK

soft suede sandal, with strap closure

- Composite toe cap
- Composite fibre penetration proof insole

EU	UK		
35	2,5	1	072160335
36	3,5	1	072160336
37	4,5	1	072160337
38	5	1	072160338
39	6	1	072160339
40	6,5	1	072160340
41	7	1	072160341
42	8	1	072160342
43	9	1	072160343
44	10	1	072160344
45	10,5	1	072160345
46	11	1	072160346
47	12	1	072160347
48	13	1	072160348



CE

S1P SRC

EN ISO 20345 2011



7216SN

suede sandal, perforated,
with strap closure

- Composite toe cap
- Composite fibre penetration proof insole

EU	UK		
35	2,5	1	072160435
36	3,5	1	072160436
37	4,5	1	072160437
38	5	1	072160438
39	6	1	072160439
40	6,5	1	072160440
41	7	1	072160441
42	8	1	072160442
43	9	1	072160443
44	10	1	072160444
45	10,5	1	072160445
46	11	1	072160446
47	12	1	072160447
48	13	1	072160448



SUZUKA



CE

S1P SRC

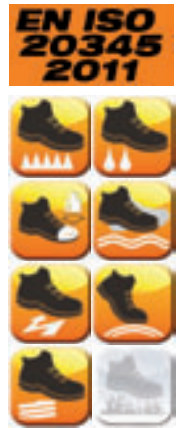

7310BKK

lace-up full-grain leather shoe, "welder" style, waterproof,
with quick opening system and front protection with strap
closure.
Durable rubber outsole

- Steel toe cap
- Composite fibre penetration proof insole

EU	UK		
38	5	1	073100238
39	6	1	073100239
40	6,5	1	073100240
41	7	1	073100241
42	8	1	073100242
43	9	1	073100243
44	10	1	073100244
45	10,5	1	073100245
46	11	1	073100246
47	12	1	073100247



CE

S3 RS HRO SRC



TREKKING

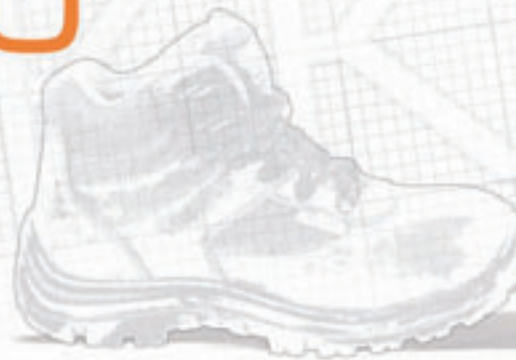

7235B

action Nubuck shoe, waterproof, with nylon inserts

- Steel toe cap
- Elastic steel penetration proof insole

EU	UK		
35	2,5	1	072350235
36	3,5	1	072350236
37	4,5	1	072350237
38	5	1	072350238
39	6	1	072350239
40	6,5	1	072350240
41	7	1	072350241
42	8	1	072350242
43	9	1	072350243
44	10	1	072350244
45	10,5	1	072350245
46	11	1	072350246
47	12	1	072350247
48	13	1	072350248



CE

S3 SRC

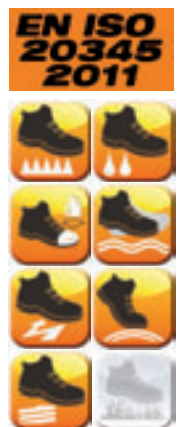

7236B

sction Nubuck ankle shoe, waterproof, with nylon inserts

- Steel toe cap
- Elastic steel penetration proof insole

EU	UK		
35	2,5	1	072360235
36	3,5	1	072360236
37	4,5	1	072360237
38	5	1	072360238
39	6	1	072360239
40	6,5	1	072360240
41	7	1	072360241
42	8	1	072360242
43	9	1	072360243
44	10	1	072360244
45	10,5	1	072360245
46	11	1	072360246
47	12	1	072360247
48	13	1	072360248



CE

S3 SRC

EN ISO 20345 2011



7237WR

suede ankle shoe with nylon inserts, durable rubber outsole and quick opening system
WR (water-resistant) footwear: after 1,000 steps in a tank with 3 cm of water, the wet internal surface has to be ≤ 3 cm² (spot)

- Composite toe cap
- Composite fibre penetration-proof insole

EU	UK		
35	2,5	1	072370235
36	3,5	1	072370236
37	4,5	1	072370237
38	5	1	072370238
39	6	1	072370239
40	6,5	1	072370240
41	7	1	072370241
42	8	1	072370242
43	9	1	072370243
44	10	1	072370244
45	10,5	1	072370245
46	11	1	072370246
47	12	1	072370247
48	13	1	072370248



CE

S3 RS WR HRO SRC

EN ISO 20345 2011



7238WR

suede ankle shoe with nylon inserts, durable rubber outsole and quick opening system
WR (water-resistant) footwear: after 1,000 steps in a tank with 3 cm of water, the wet internal surface has to be ≤ 3 cm² (spot)

- Composite toe cap
- Composite fibre penetration-proof insole

EU	UK		
35	2,5	1	072380235
36	3,5	1	072380236
37	4,5	1	072380237
38	5	1	072380238
39	6	1	072380239
40	6,5	1	072380240
41	7	1	072380241
42	8	1	072380242
43	9	1	072380243
44	10	1	072380244
45	10,5	1	072380245
46	11	1	072380246
47	12	1	072380247
48	13	1	072380248



CE

S3 RS WR HRO SRC

EN ISO 20345 2011



7248G

suede shoe with mesh inserts

- Steel toe cap
- Elastic steel penetration proof insole

EU	UK		
35	2,5	1	072480135
36	3,5	1	072480136
37	4,5	1	072480137
38	5	1	072480138
39	6	1	072480139
40	6,5	1	072480140
41	7	1	072480141
42	8	1	072480142
43	9	1	072480143
44	10	1	072480144
45	10,5	1	072480145
46	11	1	072480146
47	12	1	072480147
48	13	1	072480148



CE

S1P SRC

EN ISO 20345 2011



7249G

suede ankle shoe with mesh inserts

- Steel toe cap
- Elastic steel penetration proof insole

EU	UK		
35	2,5	1	072490135
36	3,5	1	072490136
37	4,5	1	072490137
38	5	1	072490138
39	6	1	072490139
40	6,5	1	072490140
41	7	1	072490141
42	8	1	072490142
43	9	1	072490143
44	10	1	072490144
45	10,5	1	072490145
46	11	1	072490146
47	12	1	072490147
48	13	1	072490148



CE

S1P SRC



SNEAKERS



7250NKK

suede shoe, waterproof, with microfibre inserts

- Composite toe cap with breathable membrane
- Composite fibre penetration proof insole

EU	UK		
38	5	1	072500238
39	6	1	072500239
40	6,5	1	072500240
41	7	1	072500241
42	8	1	072500242
43	9	1	072500243
44	10	1	072500244
45	10,5	1	072500245
46	11	1	072500246
47	12	1	072500247



Sepang



CE

S1P SRC

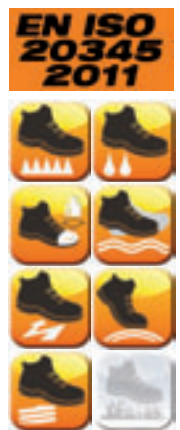

7251NKK

suede ankle shoe, waterproof, with microfibre inserts

- Composite toe cap with breathable membrane
- Composite fibre penetration proof insole

EU	UK		
38	5	1	072510238
39	6	1	072510239
40	6,5	1	072510240
41	7	1	072510241
42	8	1	072510242
43	9	1	072510243
44	10	1	072510244
45	10,5	1	072510245
46	11	1	072510246
47	12	1	072510247



Sepang



CE

S1P SRC

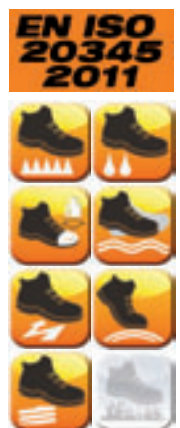

7252NKK

Nubuck ankle shoe, waterproof,
with waterproof microfibre inserts

- Composite toe cap with breathable membrane
- Composite fibre penetration proof insole

EU	UK	W	L	Code
38	5			1 072520138
39	6			1 072520139
40	6,5			1 072520140
41	7			1 072520141
42	8			1 072520142
43	9			1 072520143
44	10			1 072520144
45	10,5			1 072520145
46	11			1 072520146
47	12			1 072520147

CE



Zolder



S3 SRC

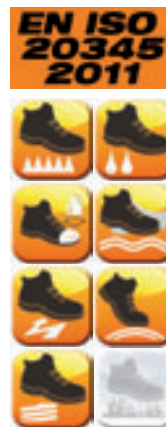

7253NKK

Nubuck ankle shoe, waterproof,
with waterproof microfibre inserts

- Composite toe cap
- Composite fibre penetration proof insole

EU	UK	W	L	Code
38	5			1 072530138
39	6			1 072530139
40	6,5			1 072530140
41	7			1 072530141
42	8			1 072530142
43	9			1 072530143
44	10			1 072530144
45	10,5			1 072530145
46	11			1 072530146
47	12			1 072530147

CE



Zolder



S3 SRC



7313B

suede shoe
with nylon mesh and PU inserts

- Fibreglass toe cap
- Composite fibre penetration proof insole

EU	UK	W	L	Code
35	2,5			1 073130835
36	3,5			1 073130836
37	4,5			1 073130837
38	5			1 073130838
39	6			1 073130839
40	6,5			1 073130840
41	7			1 073130841
42	8			1 073130842
43	9			1 073130843
44	10			1 073130844
45	10,5			1 073130845
46	11			1 073130846
47	12			1 073130847
48	13			1 073130848

CE



Monza



S1P SRC



7313G

suede shoe
with nylon mesh and PU inserts

- Fibreglass toe cap
- Composite fibre penetration proof insole

EU	UK	W	L	Code
35	2,5			1 073130635
36	3,5			1 073130636
37	4,5			1 073130637
38	5			1 073130638
39	6			1 073130639
40	6,5			1 073130640
41	7			1 073130641
42	8			1 073130642
43	9			1 073130643
44	10			1 073130644
45	10,5			1 073130645
46	11			1 073130646
47	12			1 073130647
48	13			1 073130648

CE



Monza



S1P SRC

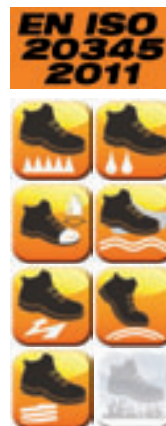

7316N

suede shoe, waterproof,
with microfibre insert

- Fibreglass toe cap
- Composite fibre penetration proof insole

EU	UK	
35	2,5	1 073160535
36	3,5	1 073160536
37	4,5	1 073160537
38	5	1 073160538
39	6	1 073160539
40	6,5	1 073160540
41	7	1 073160541
42	8	1 073160542
43	9	1 073160543
44	10	1 073160544
45	10,5	1 073160545
46	11	1 073160546
47	12	1 073160547
48	13	1 073160548

CE



Assen



S3 SRC



7323M

suede ankle shoe, waterproof,
with microfibre insert

- Fibreglass toe cap
- Composite fibre penetration proof insole

EU	UK	
35	2,5	1 073230335
36	3,5	1 073230336
37	4,5	1 073230337
38	5	1 073230338
39	6	1 073230339
40	6,5	1 073230340
41	7	1 073230341
42	8	1 073230342
43	9	1 073230343
44	10	1 073230344
45	10,5	1 073230345
46	11	1 073230346
47	12	1 073230347
48	13	1 073230348

CE



Estoril



S3 SRC



7360UN

suede shoe, waterproof

- Composite toe cap
- Composite fibre penetration-proof insole

EU	UK	
35	2,5	1 073600335
36	3,5	1 073600336
37	4,5	1 073600337
38	5	1 073600338
39	6	1 073600339
40	6,5	1 073600340
41	7	1 073600341
42	8	1 073600342
43	9	1 073600343
44	10	1 073600344
45	10,5	1 073600345
46	11	1 073600346
47	12	1 073600347
48	13	1 073600348

CE



Pergusa



S3 SRC

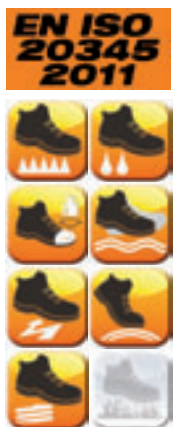

7361UB

suede shoe, perforated,
with canvas inserts, breathable

- Composite toe cap
- Composite fibre penetration-proof insole

EU	UK	Art.	Art.
35	2,5	1	073610235
36	3,5	1	073610236
37	4,5	1	073610237
38	5	1	073610238
39	6	1	073610239
40	6,5	1	073610240
41	7	1	073610241
42	8	1	073610242
43	9	1	073610243
44	10	1	073610244
45	10,5	1	073610245
46	11	1	073610246
47	12	1	073610247
48	13	1	073610248



Kyalami



CE

S1P SRC

EN ISO 20345 2011



7361UM

suede shoe, perforated,
with canvas inserts, breathable

- Composite toe cap
- Composite fibre penetration-proof insole

EU	UK	Art.	Art.
35	2,5	1	073610335
36	3,5	1	073610336
37	4,5	1	073610337
38	5	1	073610338
39	6	1	073610339
40	6,5	1	073610340
41	7	1	073610341
42	8	1	073610342
43	9	1	073610343
44	10	1	073610344
45	10,5	1	073610345
46	11	1	073610346
47	12	1	073610347
48	13	1	073610348



Kyalami



CE

S1P SRC

EN ISO 20345 2011



7368UG

suede ankle shoe, waterproof,
soft fabric collar with protective malleolar padding

- Composite toe cap
- Composite fibre penetration-proof insole

EU	UK	Art.	Art.
35	2,5	1	073680435
36	3,5	1	073680436
37	4,5	1	073680437
38	5	1	073680438
39	6	1	073680439
40	6,5	1	073680440
41	7	1	073680441
42	8	1	073680442
43	9	1	073680443
44	10	1	073680444
45	10,5	1	073680445
46	11	1	073680446
47	12	1	073680447
48	13	1	073680448



Monaco



CE

S3 SRC

EN ISO 20345 2011



7368UM

suede ankle shoe, waterproof,
soft fabric collar with protective malleolar padding

- Composite toe cap
- Composite fibre penetration-proof insole

EU	UK	Art.	Art.
35	2,5	1	073680535
36	3,5	1	073680536
37	4,5	1	073680537
38	5	1	073680538
39	6	1	073680539
40	6,5	1	073680540
41	7	1	073680541
42	8	1	073680542
43	9	1	073680543
44	10	1	073680544
45	10,5	1	073680545
46	11	1	073680546
47	12	1	073680547
48	13	1	073680548



Monaco



CE

S3 SRC

EN ISO 20345 2011



7368UN

suede ankle shoe, waterproof,
soft fabric collar with protective malleolar padding

- Composite toe cap
- Composite fibre penetration-proof insole

EU	UK		
35	2,5	1	073680335
36	3,5	1	073680336
37	4,5	1	073680337
38	5	1	073680338
39	6	1	073680339
40	6,5	1	073680340
41	7	1	073680341
42	8	1	073680342
43	9	1	073680343
44	10	1	073680344
45	10,5	1	073680345
46	11	1	073680346
47	12	1	073680347
48	13	1	073680348



Monaco



CE

S3 SRC

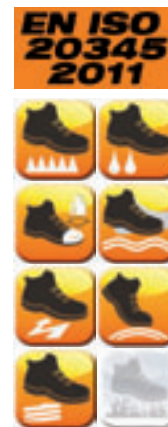

7369UB

suede ankle shoe, waterproof,
soft fabric collar with protective malleolar padding

- Composite toe cap
- Composite fibre penetration-proof insole

EU	UK		
35	2,5	1	073690235
36	3,5	1	073690236
37	4,5	1	073690237
38	5	1	073690238
39	6	1	073690239
40	6,5	1	073690240
41	7	1	073690241
42	8	1	073690242
43	9	1	073690243
44	10	1	073690244
45	10,5	1	073690245
46	11	1	073690246
47	12	1	073690247
48	13	1	073690248



Ascari



CE

S3 SRC

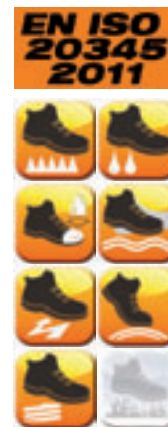

SNEAKERS PRO



7340B

mesh fabric shoe, highly breathable,
with high-frequency PU inserts and protective toe cap
reinforcement made of crust suede.
Extremely lightweight - approximate weight, size 42: 470 g

- Aluminium toe cap
- Composite fibre penetration-proof insole
- FixLock closing makes it easier to put and remove the shoe (traditional laces included)

EU	UK		
36	3,5	1	073400236
37	4,5	1	073400237
38	5	1	073400238
39	6	1	073400239
40	6,5	1	073400240
41	7	1	073400241
42	8	1	073400242
43	9	1	073400243
44	10	1	073400244
45	10,5	1	073400245
46	11	1	073400246
47	12	1	073400247



FIT PRO NET

CE

S1P SRC

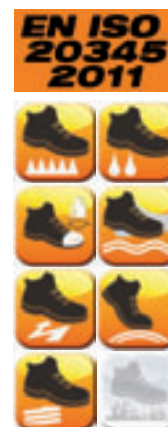

7340Y

mesh fabric shoe, highly breathable,
with high-frequency PU inserts and protective toe cap
reinforcement made of crust suede.
Extremely lightweight - approximate weight, size 42: 470 g

- Aluminium toe cap
- Composite fibre penetration-proof insole
- FixLock closing makes it easier to put and remove the shoe (traditional laces included)

**EN ISO
20345
2011**



EU	UK		
36	3,5	1	073400336
37	4,5	1	073400337
38	5	1	073400338
39	6	1	073400339
40	6,5	1	073400340
41	7	1	073400341
42	8	1	073400342
43	9	1	073400343
44	10	1	073400344
45	10,5	1	073400345
46	11	1	073400346
47	12	1	073400347



CE

S1P SRC

7340R

mesh fabric shoe, highly breathable,
with high-frequency PU inserts and protective toe cap
reinforcement made of crust suede.
Extremely lightweight - approximate weight, size 42: 470 g

- Aluminium toe cap
- Composite fibre penetration-proof insole
- FixLock closing makes it easier to put and remove the shoe (traditional laces included)

**EN ISO
20345
2011**



EU	UK		
36	3,5	1	073400436
37	4,5	1	073400437
38	5	1	073400438
39	6	1	073400439
40	6,5	1	073400440
41	7	1	073400441
42	8	1	073400442
43	9	1	073400443
44	10	1	073400444
45	10,5	1	073400445
46	11	1	073400446
47	12	1	073400447



CE

S1P SRC

7341N

microsuede shoe, waterproof,
with high-frequency PU inserts and protective toe cap
reinforcement made of crust suede.
Extremely lightweight - approximate weight, size 42: 470 g

- Aluminium toe cap
- Composite fibre penetration-proof insole
- FixLock closing makes it easier to put and remove the shoe (traditional laces included)

**EN ISO
20345
2011**



EU	UK		
36	3,5	1	073410236
37	4,5	1	073410237
38	5	1	073410238
39	6	1	073410239
40	6,5	1	073410240
41	7	1	073410241
42	8	1	073410242
43	9	1	073410243
44	10	1	073410244
45	10,5	1	073410245
46	11	1	073410246
47	12	1	073410247



CE

S3 SRC

7349RP

shoe made of Nubuck crust leather, waterproof
with rubber outsole and soft PU ring

- Composite toe cap
- Composite fibre penetration proof insole

**EN ISO
20345
2011**



EU	UK		
38	5	1	073490138
39	6	1	073490139
40	6,5	1	073490140
41	7	1	073490141
42	8	1	073490142
43	9	1	073490143
44	10	1	073490144
45	10,5	1	073490145
46	11	1	073490146
47	12	1	073490147



CE

S3 HRO SRC

7350RP

ankle shoe made of Nubuck crust leather, waterproof with rubber outsole and soft PU ring

- Composite toe cap
- Composite fibre penetration proof insole

EU	UK		
38	5	1	073500138
39	6	1	073500139
40	6,5	1	073500140
41	7	1	073500141
42	8	1	073500142
43	9	1	073500143
44	10	1	073500144
45	10,5	1	073500145
46	11	1	073500146
47	12	1	073500147



**EN ISO
20345
2011**



S3 HRO SRC



MANAGER



7290NA

full-grain leather shoe, waterproof, with reinforcement polyurethane toe cap cover and PU/TPU VIBRAM® outsole. ESD

- Composite toe cap
- Composite fibre penetration-proof insole

EU	UK		
36	3,5	1	072900336
37	4,5	1	072900337
38	5	1	072900338
39	6	1	072900339
40	6,5	1	072900340
41	7	1	072900341
42	8	1	072900342
43	9	1	072900343
44	10	1	072900344
45	10,5	1	072900345
46	11	1	072900346
47	12	1	072900347
48	13	1	072900348



Speed



**EN ISO
20345
2011**



S3 SRC ESD



7291NA

full-grain leather ankle shoe, waterproof, with reinforcement polyurethane toe cap cover and PU/TPU VIBRAM® outsole. ESD

- Composite toe cap
- Composite fibre penetration-proof insole

EU	UK		
36	3,5	1	072910336
37	4,5	1	072910337
38	5	1	072910338
39	6	1	072910339
40	6,5	1	072910340
41	7	1	072910341
42	8	1	072910342
43	9	1	072910343
44	10	1	072910344
45	10,5	1	072910345
46	11	1	072910346
47	12	1	072910347
48	13	1	072910348



Speed



**EN ISO
20345
2011**



S3 SRC ESD



7300MK

full-grain leather shoe

- Composite toe cap
- Composite fibre penetration-proof insole

EU	UK	
36	3,5	1 073000636
37	4,5	1 073000637
38	5	1 073000638
39	6	1 073000639
40	6,5	1 073000640
41	7	1 073000641
42	8	1 073000642
43	9	1 073000643
44	10	1 073000644
45	10,5	1 073000645
46	11	1 073000646
47	12	1 073000647
48	13	1 073000648



CE

S3 SRC



7300FT

full-grain leather shoe, "free time" style, waterproof, without toe cap and penetration-proof insole

- Without toe cap
- Without penetration-proof insole

EU	UK	
36	3,5	1 073000736
37	4,5	1 073000737
38	5	1 073000738
39	6	1 073000739
40	6,5	1 073000740
41	7	1 073000741
42	8	1 073000742
43	9	1 073000743
44	10	1 073000744
45	10,5	1 073000745
46	11	1 073000746
47	12	1 073000747
48	13	1 073000748

Formula



CE

O2 FO SRC



7319ESD

suede shoe, perforated, ESD

- Composite toe cap
- Composite fibre penetration-proof insole

EU	UK	
36	3,5	1 073190236
37	4,5	1 073190237
38	5	1 073190238
39	6	1 073190239
40	6,5	1 073190240
41	7	1 073190241
42	8	1 073190242
43	9	1 073190243
44	10	1 073190244
45	10,5	1 073190245
46	11	1 073190246
47	12	1 073190247
48	13	1 073190248

Mistral



CE

S1P SRC ESD

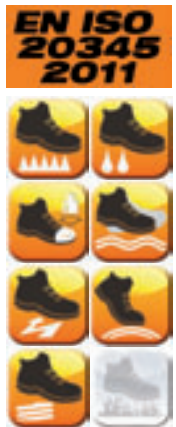

 **Beta**

HEAVY DUTY



7293NB

greased Nubuck shoe, waterproof,
with anti-abrasion microfibre insert and durable rubber outsole
Lateral ankle support

- Aluminium toe cap
- Composite fibre penetration proof insole

EU	UK	1	072930538
38	5	1	072930539
39	6	1	072930540
40	6,5	1	072930541
41	7	1	072930542
42	8	1	072930543
43	9	1	072930544
44	10	1	072930545
45	10,5	1	072930546
46	11	1	072930547
47	12	1	072930548
48	13	1	072930548



Daytona

CE

S3 HRO SRC

EN ISO
20345
2011



7293NKK

greased Nubuck shoe,
with dynamic control system
and durable VIBRAM® rubber outsole

- Composite toe cap
- Composite fibre penetration proof insole

EU	UK	1	072930138
38	5	1	072930139
39	6	1	072930140
40	6,5	1	072930141
41	7	1	072930142
42	8	1	072930143
43	9	1	072930144
44	10	1	072930145
45	10,5	1	072930146
46	11	1	072930147
47	12	1	072930148
48	13	1	072930148



CE

S3 HRO SRC

EN ISO
20345
2011



7294NB

greased ankle Nubuck shoe, waterproof,
with anti-abrasion microfibre insert and durable rubber outsole
Lateral ankle support

- Aluminium toe cap
- Composite fibre penetration proof insole

EU	UK	1	072940538
38	5	1	072940539
39	6	1	072940540
40	6,5	1	072940541
41	7	1	072940542
42	8	1	072940543
43	9	1	072940544
44	10	1	072940545
45	10,5	1	072940546
46	11	1	072940547
47	12	1	072940548
48	13	1	072940548



Daytona

CE

S3 HRO SRC

EN ISO
20345
2011



7294NKK

greased Nubuck ankle shoe,
with dynamic control system
and durable VIBRAM® rubber outsole

- Composite toe cap
- Composite fibre penetration proof insole

EU	UK		
38	5	1	072940138
39	6	1	072940139
40	6,5	1	072940140
41	7	1	072940141
42	8	1	072940142
43	9	1	072940143
44	10	1	072940144
45	10,5	1	072940145
46	11	1	072940146
47	12	1	072940147
48	13	1	072940148

CE



S3 HRO SRC

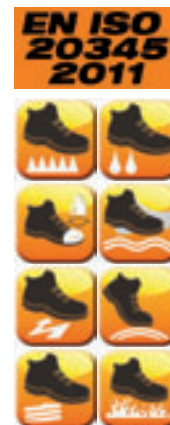

7294TKK

greased Nubuck ankle shoe,
with Thinsulate™ membrane, dynamic control system
and durable VIBRAM® rubber outsole

- Composite toe cap
- Composite fibre penetration proof insole

EU	UK		
38	5	1	072940238
39	6	1	072940239
40	6,5	1	072940240
41	7	1	072940241
42	8	1	072940242
43	9	1	072940243
44	10	1	072940244
45	10,5	1	072940245
46	11	1	072940246
47	12	1	072940247
48	13	1	072940248

CE



S3 HRO CI HI SRC

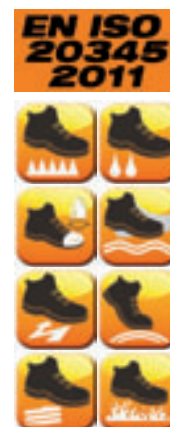

7330NV

greased Nubuck boot, waterproof, with Thinsulate™
membrane and durable VIBRAM® rubber outsole.
Real wool fur lining

- Composite toe cap
- Composite fibre penetration proof insole

EU	UK		
38	5	1	073300438
39	6	1	073300439
40	6,5	1	073300440
41	7	1	073300441
42	8	1	073300442
43	9	1	073300443
44	10	1	073300444
45	10,5	1	073300445
46	11	1	073300446
47	12	1	073300447
48	13	1	073300448

CE



S3 HRO CI SRC

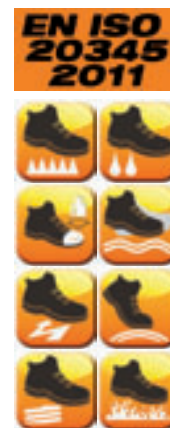

 **Beta**

ACCESSORIES



7398AL

aluminized felt insoles, for low temperatures



EU	UK		
38	5	1	073980538
39	6	1	073980539
40	6,5	1	073980540
41	7	1	073980541
42	8	1	073980542
43	9	1	073980543
44	10	1	073980544
45	10,5	1	073980545
46	11	1	073980546
47	12	1	073980547
48	13	1	073980548

7398GEL

anatomically shaped underfoot covers with gel insets



EU	UK		
35	2,5	1	073980835
36	3,5	1	073980836
37	4,5	1	073980837
38	5	1	073980838
39	6	1	073980839
40	6,5	1	073980840
41	7	1	073980841
42	8	1	073980842
43	9	1	073980843
44	10	1	073980844
45	10,5	1	073980845
46	11	1	073980846
47	12	1	073980847
48	13	1	073980848

7398U

anatomically shaped underfoot covers made of TPR GEL with high cushioning effect, plantar arch support and heel pad



EU	UK		
36 - 40	3,5 - 6,5	1	073980058
41 - 46	7 - 11	1	073980063

7398BF

anatomically shaped "BLOW-FEET" insoles



EU	UK		
36	3,5	1	073980336
37	4,5	1	073980337
38	5	1	073980338
39	6	1	073980339
40	6,5	1	073980340
41	7	1	073980341
42	8	1	073980342
43	9	1	073980343
44	10	1	073980344
45	10,5	1	073980345
46	11	1	073980346
47	12	1	073980347
48	13	1	073980348

7398EF

anatomically shaped underfoot covers made of polyurethane foam, with cushioning heel lift



EU	UK		
35	2,5	1	073981135
36	3,5	1	073981136
37	4,5	1	073981137
38	5	1	073981138
39	6	1	073981139
40	6,5	1	073981140
41	7	1	073981141
42	8	1	073981142
43	9	1	073981143
44	10	1	073981144
45	10,5	1	073981145
46	11	1	073981146
47	12	1	073981147
48	13	1	073981148

7399 A/N...

pack of 10 pairs of laces



	cm		
7399A/N 100	100	1	073990010
7399A/N 120	120	1	073990012
7399A/N 140	140	1	073990017

Prices refer to 10 pairs

7410

ankle length socks made of polypropylene with cotton and Cupron® feet



	EU		
S	37-39	1	074100001
M	40-42	1	074100002
L	43-45	1	074100003
XL	46-48	1	074100004

7413

ankle length socks made from terry and polyamide. Left and right foot specific construction



	EU		
S	37-39	1	074130001
M	40-42	1	074130002
L	43-45	1	074130003
XL	46-48	1	074130004

7417

ankle length socks made from Tactel®



	EU		
S	37-39	1	074170001
M	40-42	1	074170002
L	43-45	1	074170003
XL	46-48	1	074170004

7415

ankle length socks made from Coolmax®, Dryarn® and Cordura®



	EU		
S	37-39	1	074150001
M	40-42	1	074150002
L	43-45	1	074150003
XL	46-48	1	074150004

7416

knee length socks made from Coolmax®, Dryarn® and Cordura®



	EU		
S	37-39	1	074160001
M	40-42	1	074160002
L	43-45	1	074160003
XL	46-48	1	074160004

7418

ankle length socks made from antibacterial Meryl Skinlife®



	EU		
S	37-39	1	074180001
M	40-42	1	074180002
L	43-45	1	074180003
XL	46-48	1	074180004



BETA WORK

Over the years the workwear line has gained confidence and popularity among the most demanding professionals. The success of the product has translated into the ongoing development and expansion of the range.

The items of clothing produced by Beta Utensili S.p.a. comply with the following standard:

EN ISO 13688:2013

Personal protective equipment protects the user from limited physical hazards, including small abrasions, sunbeams, wind, cold, non-harmful powders and dirt from nontoxic materials. Such protection is related to the first category of Italian Parliamentary Bill n°. 475 of 04/12/1992.

USE AND STORAGE INSTRUCTIONS

The garment should be worn correctly, so that it can protect the user's body parts. It should be stored in a cool, dry place, in its original packaging, away from heat sources, sunlight, dust and adverse weather.

PACKAGING

- WORKWEAR: hanging bag
- FREE TIME WEAR: non-hanging bag

SHRINKAGE

All natural fibres shrink after being washed. The degree of shrinkage may range from 1% to 5%, depending on several parameters, which include the type of fibres and the temperature of water.



	I	F	D	E	UK	USA
XS	46	38	42	40	30	32
S	48	40	44	42	32	34
M	50	42	46	44	34	36
L	52	44	48	46	36	38
XL	54	46	50	48	38	40
XXL	56	48	52	50	40	42
XXXL	58	50	54	52	42	44
4XL	60	52	56	54	44	46

Beta EN ISO 13688:2013

	XS	S	M	L	XL	2XL	3XL	4XL
A	88-92	92-96	96-104	104-108	108-116	116-124	124-132	132-140
B	79-83	83-87	87-91	91-95	95-100	100-107	107-112	112-120
H	158-164	164-170	170-176	176-182	182-188	188-194	194-200	200-206





7525

prewashed stretch work jeans, 68% denim cotton, 29% polyester, 3% stretch fabric, 10 ounces

CE



XS	1 075250046
S	1 075250048
M	1 075250050
L	1 075250052
XL	1 075250054
XXL	1 075250056
XXXL	1 075250058

7526

work jeans in stretch denim cotton, prewashed 68% denim cotton, 29% polyester, 3% stretch fabric, 10 ounces
Polyester 600D reinforcements in rear pockets and on leg bottoms. Slim fit

CE



XS	1 075260046
S	1 075260048
M	1 075260050
L	1 075260052
XL	1 075260054
XXL	1 075260056
XXXL	1 075260058

7815N

work trousers, multipocket style, twisted T/C canvas, 280 g/m² with polyester inserts, black

CE



XS	1 078150000
S	1 078150001
M	1 078150002
L	1 078150003
XL	1 078150004
XXL	1 078150005
XXXL	1 078150006

7816BL

work trousers, multipocket style, T/C canvas, 260 g/m², blue
Knee pad pockets and leg bottoms reinforced in polyester 600D, tearproof crotch and stretch rear insert for easier movements

CE



XS	1 078160100
S	1 078160101
M	1 078160102
L	1 078160103
XL	1 078160104
XXL	1 078160105
XXXL	1 078160106

7816G

work trousers, multipocket style, in T/C canvas 260 g/m², grey
Knee pad pockets and leg bottoms reinforced in polyester 600D, tearproof crotch and elastic rear insert for easier movements

CE



XS	1 078160000
S	1 078160001
M	1 078160002
L	1 078160003
XL	1 078160004
XXL	1 078160005
XXXL	1 078160006

7880SC

stretch work trousers,
T/C canvas, 290 g/m², black
Slim fit, tearproof crotch and stretch waistband
on sides

CE



SIZE	QTY	SKU
XS	1	078800000
S	1	078800001
M	1	078800002
L	1	078800003
XL	1	078800004
XXL	1	078800005
XXXL	1	078800006

7546BL

three-button polo shirt, pique cotton, 220 g/m²,
blue



SIZE	QTY	SKU
XS	2	075460000
S	2	075460001
M	2	075460002
L	2	075460003
XL	2	075460004
XXL	2	075460005
XXXL	2	075460006

7546G

three-button polo shirt, pique cotton, 220 g/m²,
grey



SIZE	QTY	SKU
XS	2	075460100
S	2	075460101
M	2	075460102
L	2	075460103
XL	2	075460104
XXL	2	075460105
XXXL	2	075460106

7546N

three-button polo shirt, pique cotton, 220 g/m²,
black



SIZE	QTY	SKU
XS	2	075460200
S	2	075460201
M	2	075460202
L	2	075460203
XL	2	075460204
XXL	2	075460205
XXXL	2	075460206

7548BL

work t-shirt, 100% jersey cotton, 180 g/m²,
blue



SIZE	QTY	SKU
XS	5	075480000
S	5	075480001
M	5	075480002
L	5	075480003
XL	5	075480004
XXL	5	075480005
XXXL	5	075480006

7548G

work t-shirt, 100% jersey cotton, 180 g/m²,
grey



SIZE	QTY	SKU
XS	5	075480100
S	5	075480101
M	5	075480102
L	5	075480103
XL	5	075480104
XXL	5	075480105
XXXL	5	075480106

7548N

work t-shirt, 100% jersey cotton, 180 g/m²,
black



SIZE	QTY	SKU
XS	5	075480200
S	5	075480201
M	5	075480202
L	5	075480203
XL	5	075480204
XXL	5	075480205
XXXL	5	075480206

SHIRT & T-SHIRT



FLEECE



7622G

fleece jacket, 280 g/m², with polyester inserts, anthracite grey/black



XS	1	076220000
S	1	076220001
M	1	076220002
L	1	076220003
XL	1	076220004
XXL	1	076220005
XXXL	1	076220006

7632G

fleece pullover, 280 g/m², with polyester inserts, anthracite grey/black



XS	1	076320000
S	1	076320001
M	1	076320002
L	1	076320003
XL	1	076320004
XXL	1	076320005
XXXL	1	076320006

7635N

microfleece sweater, short-zipped, 180 g/m² black



XS	1	076350500
S	1	076350501
M	1	076350502
L	1	076350503
XL	1	076350504
XXL	1	076350505
XXXL	1	076350506

7635G

microfleece sweater, short-zipped, 180 g/m² anthracite grey



XS	1	076350510
S	1	076350511
M	1	076350512
L	1	076350513
XL	1	076350514
XXL	1	076350515
XXXL	1	076350516

7636BL

microfleece sweater, long-zipped, 180 g/m², blue, waist pockets with zip closure



XS	1	076360000
S	1	076360001
M	1	076360002
L	1	076360003
XL	1	076360004
XXL	1	076360005
XXXL	1	076360006

JACKETS



7577N

sleeveless jacket, 100% 50D microfibre polyester, padded, lined, black
Elastic insert at armhole



XS	1	075770000
S	1	075770001
M	1	075770002
L	1	075770003
XL	1	075770004
XXL	1	075770005
XXXL	1	075770006

7578G

sleeveless jacket, ripstop nylon, waterproof, padded, lined, anthracite grey
Stretch armhole



SIZE	QTY	SKU
XS	1	075780000
S	1	075780001
M	1	075780002
L	1	075780003
XL	1	075780004
XXL	1	075780005
XXXL	1	075780006

7683

softshell jacket, 94% polyester, 6% spandex, 290 g/m² with detachable hood and sleeves, black/orange
Waterproof three layer fabric, with waterproof, windproof, breathable TPU membrane



SIZE	QTY	SKU
S	1	076830001
M	1	076830002
L	1	076830003
XL	1	076830004
XXL	1	076830005
XXXL	1	076830006

7684

softshell jacket, 94% polyester, 6% spandex, 290 g/m² black/grey
Waterproof three layer fabric, with waterproof, windproof, breathable TPU membrane



SIZE	QTY	SKU
S	1	076840001
M	1	076840002
L	1	076840003
XL	1	076840004
XXL	1	076840005
XXXL	1	076840006

7685

bomber jacket, made of nylon 20D, with down-like polyester padding, 80 g/m², blue
Supplied in a convenient, room-saving bag



SIZE	QTY	SKU
S	1	076850001
M	1	076850002
L	1	076850003
XL	1	076850004
XXL	1	076850005
XXXL	1	076850006

7685BL

nylon 20D bomber jacket, with polyester down-like padding, 80 g/m², blue
Supplied in a convenient, room-saving bag



SIZE	QTY	SKU
S	1	076850101
M	1	076850102
L	1	076850103
XL	1	076850104
XXL	1	076850105
XXXL	1	076850106

7734

triple use Anorak jacket made of Oxford polyester 300D, waterproof, PU-coated, grey
With foldaway hood and detachable interior jacket, 100% made of polyester, black



SIZE	QTY	SKU
S	1	077340001
M	1	077340002
L	1	077340003
XL	1	077340004
XXL	1	077340005
XXXL	1	077340006

7780N

anorak, 100% 230D doobby polyester, waterproof, padded, lined, black
Detachable hood and sleeves



SIZE	QTY	SKU
XS	1	077800000
S	1	077800001
M	1	077800002
L	1	077800003
XL	1	077800004
XXL	1	077800005
XXXL	1	077800006

BASIC

7840BL

work trousers, T/C twill, 245 g/m², blue
Stretch waistband on sides



XS	1	078400100
S	1	078400101
M	1	078400102
L	1	078400103
XL	1	078400104
XXL	1	078400105
XXXL	1	078400106
XXXXL	1	078400107

7849BL

work jacket, T/C twill, 245 g/m², blue
Stretch waistband



XS	1	078490100
S	1	078490101
M	1	078490102
L	1	078490103
XL	1	078490104
XXL	1	078490105
XXXL	1	078490106
XXXXL	1	078490107

EASY LIGHT

7860E

work trousers, lightweight,
T/C twill, 180 g/m², with Oxford inserts, grey



XS	1	078600900
S	1	078600901
M	1	078600902
L	1	078600903
XL	1	078600904
XXL	1	078600905
XXXL	1	078600906
XXXXL	1	078600907

7861E

work Bermuda shorts, lightweight,
T/C twill, 180 g/m², grey



XS	1	078610900
S	1	078610901
M	1	078610902
L	1	078610903
XL	1	078610904
XXL	1	078610905
XXXL	1	078610906
XXXXL	1	078610907

7863E

work overalls, lightweight
T/C twill, 180 g/m², with Oxford inserts, grey



XS	1	078630900
S	1	078630901
M	1	078630902
L	1	078630903
XL	1	078630904
XXL	1	078630905
XXXL	1	078630906
XXXXL	1	078630907

7865E

work overalls, lightweight
T/C twill, 180 g/m², with Oxford inserts, grey



XS	1	078650900
S	1	078650901
M	1	078650902
L	1	078650903
XL	1	078650904
XXL	1	078650905
XXXL	1	078650906
XXXXL	1	078650907

7867E

sleeveless work jacket, multipocket style, lightweight, T/C twill, 180 g/m², with Oxford inserts, grey



XS	1	078670900
S	1	078670901
M	1	078670902
L	1	078670903
XL	1	078670904
XXL	1	078670905
XXXL	1	078670906
XXXXL	1	078670907

7869E

work jacket, lightweight, T/C twill, 180 g/m² with Oxford inserts, grey



XS	1	078690900
S	1	078690901
M	1	078690902
L	1	078690903
XL	1	078690904
XXL	1	078690905
XXXL	1	078690906
XXXXL	1	078690907

7870E

work trousers, lightweight, T/C twill 180 g/m², with Oxford inserts, blue



XS	1	078700900
S	1	078700901
M	1	078700902
L	1	078700903
XL	1	078700904
XXL	1	078700905
XXXL	1	078700906
XXXXL	1	078700907

7871E

work Bermuda shorts, lightweight T/C twill 180 g/m², blue



XS	1	078710900
S	1	078710901
M	1	078710902
L	1	078710903
XL	1	078710904
XXL	1	078710905
XXXL	1	078710906
XXXXL	1	078710907

7873E

work overalls, lightweight T/C twill 180 g/m², with Oxford inserts, blue



XS	1	078730900
S	1	078730901
M	1	078730902
L	1	078730903
XL	1	078730904
XXL	1	078730905
XXXL	1	078730906
XXXXL	1	078730907

7875E

work overall, lightweight T/C twill 180 g/m², with Oxford inserts, blue



XS	1	078750900
S	1	078750901
M	1	078750902
L	1	078750903
XL	1	078750904
XXL	1	078750905
XXXL	1	078750906
XXXXL	1	078750907

EASY
LIGHT BLUE

Beta

7877E

sleeveless work jacket, multipocket style, lightweight T/C twill 180 g/m², with Oxford inserts, blue

CE



XS	1 078770900
S	1 078770901
M	1 078770902
L	1 078770903
XL	1 078770904
XXL	1 078770905
XXXL	1 078770906
XXXXL	1 078770907

7879E

work jacket, lightweight, T/C twill 180 g/m², with Oxford inserts, blue

CE



XS	1 078790900
S	1 078790901
M	1 078790902
L	1 078790903
XL	1 078790904
XXL	1 078790905
XXXL	1 078790906
XXXXL	1 078790907

7900E

work trousers, multipocket style, in T/C canvas, 260 g/m², Oxford insets, grey

CE



XS	1 079000900
S	1 079000901
M	1 079000902
L	1 079000903
XL	1 079000904
XXL	1 079000905
XXXL	1 079000906
XXXXL	1 079000907

7901E

work Bermuda shorts in T/C canvas, 260 g/m², grey

CE



XS	1 079010900
S	1 079010901
M	1 079010902
L	1 079010903
XL	1 079010904
XXL	1 079010905
XXXL	1 079010906
XXXXL	1 079010907

7903E

work overalls in T/C canvas, 260 g/m², Oxford insets, grey

CE



XS	1 079030900
S	1 079030901
M	1 079030902
L	1 079030903
XL	1 079030904
XXL	1 079030905
XXXL	1 079030906
XXXXL	1 079030907

7905E

work overalls in T/C canvas, 260 g/m², Oxford insets, grey

CE



XS	1 079050900
S	1 079050901
M	1 079050902
L	1 079050903
XL	1 079050904
XXL	1 079050905
XXXL	1 079050906
XXXXL	1 079050907



7904E

work bomber jacket, T/C canvas, 260 g/m², padded, lined, "Oxford" insets, grey

CE

Beta EASY



XS	1	079040900
S	1	079040901
M	1	079040902
L	1	079040903
XL	1	079040904
XXL	1	079040905
XXXL	1	079040906
XXXXL	1	079040907

7907E

sleeveless work jacket, multipocket style, in T/C canvas, 260 g/m², Oxford insets, grey

CE

Beta EASY



XS	1	079070900
S	1	079070901
M	1	079070902
L	1	079070903
XL	1	079070904
XXL	1	079070905
XXXL	1	079070906
XXXXL	1	079070907

7909E

work jacket in T/C canvas, 260 g/m², Oxford insets, grey

CE

Beta EASY



XS	1	079090900
S	1	079090901
M	1	079090902
L	1	079090903
XL	1	079090904
XXL	1	079090905
XXXL	1	079090906
XXXXL	1	079090907

STRETCH

7830ST (ex 7816ST)

stretch work trousers, T/C twill, 250 g/m², grey
Slim fit, tearproof crotch and stretch waistband on sides

CE



XS	1	078300000
S	1	078300001
M	1	078300002
L	1	078300003
XL	1	078300004
XXL	1	078300005
XXXL	1	078300006

7831ST

stretch work Bermuda shorts, T/C twill, 250 g/m², grey
Slim fit, tearproof crotch and stretch waistband on sides

CE



XS	1	078310000
S	1	078310001
M	1	078310002
L	1	078310003
XL	1	078310004
XXL	1	078310005
XXXL	1	078310006

7833ST

stretch work overalls, T/C twill, 250 g/m², grey
Slim fit, tearproof crotch and stretch waistband

CE



XS	1	078330000
S	1	078330001
M	1	078330002
L	1	078330003
XL	1	078330004
XXL	1	078330005
XXXL	1	078330006

7835ST

stretch work overalls, T/C twill, 250 g/m², grey
Slim fit, tearproof crotch and stretch waistband

CE



XS	1	078350000
S	1	078350001
M	1	078350002
L	1	078350003
XL	1	078350004
XXL	1	078350005
XXXL	1	078350006

TOP LINE

7820

work trousers, twisted T/C canvas, 280 g/m², Cordura® and Reflex 3M Scotchlite™ insets, black/grey

CE



Size	Quantity	Code
XS	1	078200000
S	1	078200001
M	1	078200002
L	1	078200003
XL	1	078200004
XXL	1	078200005
XXXL	1	078200006
XXXXL	1	078200007

7821

work Bermuda shorts, twisted T/C canvas, 280 g/m², black/grey

CE



Size	Quantity	Code
XS	1	078210000
S	1	078210001
M	1	078210002
L	1	078210003
XL	1	078210004
XXL	1	078210005
XXXL	1	078210006
XXXXL	1	078210007

7823

work overalls, twisted T/C canvas, 280 g/m², Cordura® and Reflex 3M Scotchlite™ insets, black/grey

CE



Size	Quantity	Code
XS	1	078230000
S	1	078230001
M	1	078230002
L	1	078230003
XL	1	078230004
XXL	1	078230005
XXXL	1	078230006
XXXXL	1	078230007

7825

work overalls, twisted T/C canvas, 280 g/m², Cordura® and Reflex 3M Scotchlite™ insets, black/grey

CE



Size	Quantity	Code
XS	1	078250000
S	1	078250001
M	1	078250002
L	1	078250003
XL	1	078250004
XXL	1	078250005
XXXL	1	078250006
XXXXL	1	078250007

7829

work jacket, twisted T/C canvas, 280 g/m², Cordura® and Reflex 3M Scotchlite™ insets, black/grey

CE



Size	Quantity	Code
XS	1	078290000
S	1	078290001
M	1	078290002
L	1	078290003
XL	1	078290004
XXL	1	078290005
XXXL	1	078290006
XXXXL	1	078290007

COTTON

7930P

work trousers, 100% cotton, 260 g/m², payne grey

CE



Size	Quantity	Code
XS	1	079300100
S	1	079300101
M	1	079300102
L	1	079300103
XL	1	079300104
XXL	1	079300105
XXXL	1	079300106

7931P

work shorts, 100% cotton, 260 g/m²,
payne grey

CE



MEASUREMENTS	ITEM
XS	1 079310100
S	1 079310101
M	1 079310102
L	1 079310103
XL	1 079310104
XXL	1 079310105
XXXL	1 079310106

7933P

work overalls, 100% cotton, 260 g/m²,
payne grey

CE



MEASUREMENTS	ITEM
XS	1 079330100
S	1 079330101
M	1 079330102
L	1 079330103
XL	1 079330104
XXL	1 079330105
XXXL	1 079330106

Beta

7935P

work overalls, 100% cotton, 260 g/m²,
payne grey

CE



MEASUREMENTS	ITEM
XS	1 079350100
S	1 079350101
M	1 079350102
L	1 079350103
XL	1 079350104
XXL	1 079350105
XXXL	1 079350106

7939P

work jacket, 100% cotton, 260 g/m²,
payne grey

CE



MEASUREMENTS	ITEM
XS	1 079390100
S	1 079390101
M	1 079390102
L	1 079390103
XL	1 079390104
XXL	1 079390105
XXXL	1 079390106

RAIN



7970

waterproof trousers in PVC Tricot, blue

CE



MEASUREMENTS	ITEM
XS	1 079700000
S	1 079700001
M	1 079700002
L	1 079700003
XL	1 079700004
XXL	1 079700005
XXXL	1 079700006

Beta

7971E

waterproof trousers, PVC-coated polyester, with thermo-taped seams, blue

CE

Beta EASY



XS	1	079710000
S	1	079710001
M	1	079710002
L	1	079710003
XL	1	079710004
XXL	1	079710005
XXXL	1	079710006

7973

waterproof overalls in PVC Tricot, blue

CE



XS	1	079730000
S	1	079730001
M	1	079730002
L	1	079730003
XL	1	079730004
XXL	1	079730005
XXXL	1	079730006

7978E

waterproof jacket, PVC-coated polyester, with thermo-taped seams, blue

CE

Beta EASY



XS	1	079780000
S	1	079780001
M	1	079780002
L	1	079780003
XL	1	079780004
XXL	1	079780005
XXXL	1	079780006

7979

waterproof jacket in PVC Tricot, blue

CE



S	1	079790001
M	1	079790002
L	1	079790003
XL	1	079790004
XXL	1	079790005
XXXL	1	079790006



7991N

technical underpants, 100% polyester, 130 g/m², black



S	1	079910001
M	1	079910002
L	1	079910003
XL	1	079910004
XXL	1	079910005

7992N

technical undershirt, long-sleeved, 100% polyester, 130 g/m², black



S	1	079920001
M	1	079920002
L	1	079920003
XL	1	079920004
XXL	1	079920005



ACCESSORIES

7800G

work knee pads pair



7800G

1 078000500

7981T

cap, 100% made of acrylic fibre, lined in Thinsulate™ 40 g/m², black



7981T

10 079810111

7984

work belt, 90% polyester, 10% cotton, one-size-fits-all, 130 cm long (can be shortened), 35 mm wide anthracite grey



7984

1 079840130

7985

neck warmer made of microfleece, with adjuster, black can also be used as a cap



7985

10 079850111

7190C

PVC ear protectors

• attenuation values: from 15.5 dB at 63 Hz to 37 dB at 8000 Hz

CE



EN 352-1

7190C

2 071900002

7195A

dust mask

CE



7195A

10 071950004

7051MP

eye protector with polycarbonate visor

CE



EN166

7051MP

5 070510001

7061TC

safety glasses with clear polycarbonate lenses

CE

EASY



7061TC

1 070610001

7076BC

safety glasses with clear polycarbonate lenses

CE

SPORT



EN166F-1F
EN172
UV 5-3.1

7076BC

1 070760009

7076BD

safety glasses with polycarbonate lenses

CE

SPORT



EN166F-1F
EN170
UV 5-2.5

7076BD

1 070760019

7076BP

safety glasses with polarized polycarbonate lenses

CE

SPORT



EN12311

7076BP

1 070760029

7076BU

leak detection glasses with UV lights

CE



EN12312-1

7076BU

1 070760039

7093BC

safety glasses with clear polycarbonate lenses

CE

IMPACT



EN166F-1F
EN170
UV400

7093BC

1 070930009

7093BD

safety glasses with dark polycarbonate lenses

CE
IMPACT



EN166F-1F
EN172
UV5-2.5

7093BD

1 070930019

C62M/W

mannequin



185
cm

65 cm

C62M/W

1 062000360

C62EV/CP

footwear display stand, 15 positions



1700 mm

460 mm

C62EV/CP

1 062000401

C63 E/W

clothing and footwear display stand



2250 mm

515 mm

1010 mm

C63E/W

1 063000010

C63 G/C

footwear "gondola" display



1010 mm

1010 mm

515 mm

C63G/C

1 063000020

6200AP/S10

set of 10 hangers



6200AP/S10

1 062000331

Beta

Beta

Robur



Special free service boxes
on page 491

Since 1930 Robur has been manufacturing accessory lines for cables according to the acknowledged quality standards of Beta Utensili, whose products are complementary to those of Robur.

Expertise, organization and technology are the key ingredients of ongoing growth resulting from awareness of market requirements.

Since 1984 Robur has been headquartered in a state-of-the-art production facility in Sulmona.

MAXIMUM WORKING LOAD

WLL: working load limit
(for lifting accessories)

WFL: workforce limit
(for accessories other
than lifting accessories)

BF: Maximum force achieved
by the item during the static
traction test

LC: lashing capacity

KEY READING

8060R - 8060

Clevis chain hooks,
high-tensile alloy steel

CE



EN 1677-2
GRADE 8

size

size	WLL kg	Ø mm	C mm	price	code number
8060R	1120	6	19	1	080600111
8060R	2000	7-8	23	1	080600120
8060R	3150	10	27	1	080600132
8060R	5300	13	35	1	080600153
8060	8000	16	48	1	080600080

n.° of tools
per box

• 4 DIFFERENT TYPES OF CERTIFICATES

• 140 UPDATED PRODUCT SPECIFICATIONS

Item	Test Report 2.2 (UNI EN 10204)	Test Certificate 3.1(UNI EN 10204)	Manufacturer's Certificate	CE Declaration of Conformity
8001Z	✓	✓		✓
8001TZ	✓	✓		✓
8002ZD	✓			
8003ZD	✓			
8004ND	✓			
8005Z	✓			✓
8005TZ	✓			✓
8006Z	✓			✓
8007Z	✓			✓
8008N	✓			✓
8009FD	✓			
8009Z	✓			✓
8009TZ	✓			✓
8010Z	✓			✓
8016	✓			✓
8016DA	✓			✓
8016DF	✓			✓
8016FR	✓			
8016U	✓		✓	✓
8018E	✓			
8018T	✓			
8020	✓			
8021	✓			
8025	✓	✓		✓
8026A	✓	✓		✓
8026R	✓	✓		✓
8028	✓	✓		✓
8029	✓	✓		✓
8029R	✓	✓		✓
8031R	✓	✓		✓
8032	✓	✓		✓
8040EN	✓	✓		✓
8040EZ	✓	✓		✓
8042EN	✓	✓		✓
8042EZ	✓	✓		✓
8044	✓	✓		✓
8048	✓			
8049	✓	✓		✓
8051S	✓	✓		✓
8052	✓	✓		✓
8055S	✓	✓		✓
8057	✓	✓		✓
8058	✓	✓		✓
8060	✓	✓		✓
8061F	✓	✓		✓
8062	✓	✓		✓
8064S	✓	✓		✓
8065SC	✓	✓		✓
8074	✓			
8080	✓			
8085	✓	✓		✓

Item	Test Report 2.2 (UNI EN 10204)	Test Certificate 3.1(UNI EN 10204)	Manufacturer's Certificate	CE Declaration of Conformity
8086	✓	✓		✓
8090	✓	✓		✓
8090F	✓	✓		✓
8090R	✓	✓		✓
8091			✓	✓
8092			✓	✓
8094			✓	✓
8096			✓	✓
8097			✓	✓
8098			✓	✓
8100	✓	✓		✓
8105	✓			
8109	✓			
8114	✓			
8116	✓			
8130A	✓			
8139DL	✓			
8150	✓		✓	✓
8153	✓		✓	✓
8156	✓		✓	✓
8157	✓		✓	✓
8158	✓		✓	✓
8159	✓		✓	✓
8160	✓		✓	✓
8161	✓		✓	✓
8166	✓			
8170	✓		✓	✓
8173	✓		✓	✓
8176	✓		✓	✓
8177	✓		✓	✓
8178	✓		✓	✓
8180	✓			
8181	✓			
8181S	✓			
8182	✓			
8182A	✓			
8182E	✓			
8182S	✓			
8185	✓			
8186	✓			
8187	✓			
8188C	✓			
8188CG/25	✓			
8188F	✓			
8188F/35	✓			
8188FG2	✓			
8188FG3	✓			
8302Z	✓			
8303Z	✓			
8317DZ	✓			
8317SZ	✓			

Item	Test Report 2.2 (UNI EN 10204)	Test Certificate 3.1(UNI EN 10204)	Manufacturer's Certificate	CE Declaration of Conformity
8381SL	✓			
8381SP	✓			
8383C	✓			
8383P	✓			
8515V	✓			
8515Z	✓			
8531	✓			
8532	✓			
8535	✓			
8201T	✓			
8205	✓			
8206	✓			
8207	✓			
8209	✓			
8210	✓			
8216	✓			✓
8220	✓			
8225	✓			
8227	✓			
8228	✓			
8240	✓			
8240F	✓	✓		✓
8242	✓			
8242F	✓	✓		✓
8248	✓			
8249	✓			
8249G	✓			
8250	✓			
8264	✓			
8267	✓			
8272	✓			
8273	✓			
8274	✓			
8274A	✓			
8274G	✓			
8276	✓			
8276G	✓			
8278	✓			
8280	✓			
8282	✓			
8284	✓			
8285	✓			
8286	✓			
8287	✓			
8290	✓			
8293	✓			
8297C	✓			
8297F	✓			
8381SX	✓			

8001Z

turnbuckle bodies,
galvanized



TECHNICAL DATA

- safety factor: 4
 - traceability code
- LABORATORY TESTS

- chemical analysis
- tensile test

AVAILABLE CERTIFICATES

- Technical product specifications
- Test report UNI EN10204 type 2.2
- CE Declaration of Conformity

ø mm	ø "	L mm	WFL kg		
M5	3/16	80	115	100	080010105
M6	1/4	80	160	100	080010106
M8	5/16	105	300	25	080010108
M10	3/8	125	470	20	080010110
M11	7/16	135	580	15	080010111
M12	1/2	140	690	20	080010112
M14	9/16	170	940	15	080010114
M16	5/8	190	1290	15	080010116
M18	11/16	205	1660	10	080010118
M20	3/4	220	2130	10	080010120
M22	7/8	240	2630	8	080010122
M24	1"	260	3060	5	080010124
M27	1 1/8	270	4000	1	080010127
M30	1 3/16	280	4860	1	080010130
M33	1 1/4	290	6040	1	080010133
M36*	1 3/8	300	6500	1	080010198
M39*	1 1/2	300	7900	1	080010199

Whitworth thread subject to availability
New batches with metric thread

8001TZ

pipe turnbuckle bodies,
galvanized



DIN 1478

TECHNICAL DATA

- safety factor: 4
 - traceability code
- LABORATORY TESTS

- chemical analysis
- tensile test

AVAILABLE CERTIFICATES

- Technical product specifications
- Test report UNI EN10204 type 2.2
- CE Declaration of Conformity

ø mm	ø "	L mm	WFL kg		
M12	1/2	125	690	10	080010512
M16	5/8	170	1290	5	080010516
M20	3/4	200	2130	5	080010520
M24	1	255	3060	3	080010524
* M27	1.1/8	255	4000	1	080010527
M30	1.3/16	255	4860	1	080010530
M36	1.3/8	295	6500	1	080010536
M42	1.5/8	330	9700	1	080010542

* Sizes not contemplated by the standard

8002ZD

turnbuckle eyes
right thread, galvanized



TECHNICAL DATA

- safety factor: 4
- LABORATORY TESTS

- chemical analysis
- tensile test

AVAILABLE CERTIFICATES

- Technical product specifications
- Test report UNI EN10204 type 2.2

ø mm	ø "	E mm	WFL kg		
M5	3/16	37	115	200	080020105
M6	1/4	40	160	150	080020106
M8	5/16	52	300	100	080020108
M10	3/8	60	470	100	080020110
M11	7/16	65	580	1	080020111
M12	1/2	72	690	50	080020112
M14	9/16	85	940	1	080020114
M16	5/8	95	1290	1	080020116
M18	11/16	103	1660	1	080020118
M20	3/4	110	2130	1	080020120
M22	7/8	120	2630	1	080020122
M24	1"	130	3060	1	080020124
M27	1 1/8	135	4000	1	080020127
M30	1 3/16	140	4860	1	080020130
M33	1 1/4	148	6040	1	080020133
M36*	1 3/8	150	6500	1	080020198
M39*	1 1/2	150	7900	1	080020199

Whitworth thread subject to availability
New batches with metric thread

left-handed thread

ø mm	ø "	E mm	WFL kg		
M5	3/16	37	115	1	080020305
M6	1/4	40	160	1	080020306
M8	5/16	52	300	1	080020308
M10	3/8	60	470	1	080020310
M11	7/16	65	580	1	080020311
M12	1/2	72	690	1	080020312
M14	9/16	85	940	1	080020314
M16	5/8	95	1290	1	080020316
M18	11/16	103	1660	1	080020318
M20	3/4	110	2130	1	080020320
M22	7/8	120	2630	1	080020322
M24	1"	130	3060	1	080020324
M27	1 1/8	135	4000	1	080020327
M30	1 3/16	140	4860	1	080020330
M33	1 1/4	148	6040	1	080020333
M36*	1 3/8	150	6500	1	080020398
M39*	1 1/2	150	7900	1	080020399



8004ND

turnbuckle stubs
right-handed thread, self-coloured



TECHNICAL DATA

- safety factor: 4
- LABORATORY TESTS

- chemical analysis
- tensile test

AVAILABLE CERTIFICATES

- Technical product specifications
- Test report UNI EN10204 type 2.2

ø mm	ø "	E mm	WFL kg		
M5	3/16	40	115	1	080040005
M6	1/4	44	160	1	080040006
M8	5/16	53	300	1	080040008
M10	3/8	63	470	1	080040010
M12	1/2	70	690	1	080040012
M14	9/16	85	940	1	080040014
M16	5/8	95	1290	1	080040016
M18	11/16	103	1660	1	080040018
M20	3/4	110	2130	1	080040020
M22	7/8	120	2630	1	080040022
M24	1"	130	3060	1	080040024
M27	1 1/8	135	4000	1	080040027
M30	1 3/16	140	4860	1	080040030
M33	1 1/4	150	6040	1	080040033
M36*	1 3/8	150	6500	1	080040098
M39*	1 1/2	150	7900	1	080040099

Whitworth thread subject to availability
New batches with metric thread

left-handed thread

ø mm	ø "	E mm	WFL kg		
M5	3/16	40	115	1	080040105
M6	1/4	44	160	1	080040106
M8	5/16	53	300	1	080040108
M10	3/8	63	470	1	080040110
M12	1/2	70	690	1	080040112
M14	9/16	85	940	1	080040114
M16	5/8	95	1290	1	080040116
M18	11/16	103	1660	1	080040118
M20	3/4	110	2130	1	080040120
M22	7/8	120	2630	1	080040122
M24	1"	130	3060	1	080040124
M27	1 1/8	135	4000	1	080040127
M30	1 3/16	140	4860	1	080040130
M33	1 1/4	150	6040	1	080040133
M36*	1 3/8	150	6500	1	080040198
M39*	1 1/2	150	7900	1	080040199

8008N

stub and stub turnbuckles
self-coloured

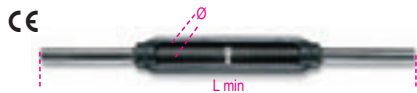

TECHNICAL DATA

- safety coefficient: 4
- LABORATORY TESTS
- chemical analysis
- tensile test

AVAILABLE CERTIFICATES

- Technical product specifications
- Test report UNI EN10204 type 2.2
- CE Declaration of Conformity

Ø mm	Ø "	L min mm	WFL kg		
M5	3/16	160	115	30	080080205
M6	1/4	180	160	30	080080206
M8	5/16	210	300	20	080080208
M10	3/8	250	470	15	080080210
M12	1/2	280	690	15	080080212
M14	9/16	340	940	5	080080214
M16	5/8	380	1290	5	080080216
M18	11/16	410	1660	3	080080218
M20	3/4	440	2130	3	080080220
M22	7/8	480	2630	2	080080222
M24	1"	520	3060	2	080080224
M27	1 1/8	560	4000	1	080080227
M30	1 3/16	560	4860	1	080080230
M33	1 1/4	600	6040	1	080080233
M36*	1 3/8	600	6500	1	080080236
M39*	1 1/2	600	7900	1	080080239

Whitworth thread subject to availability
New batches with metric thread

8009Z

jaw and jaw turnbuckles,
galvanized

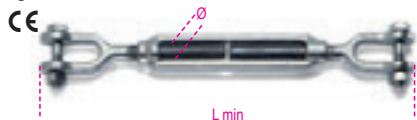

TECHNICAL DATA

- safety coefficient: 4
- LABORATORY TESTS
- chemical analysis
- tensile test

AVAILABLE CERTIFICATES

- Technical product specifications
- Test report UNI EN10204 type 2.2
- CE Declaration of Conformity

Ø mm	Ø "	L min mm	WFL kg		
M8	5/16	192	300	15	080090008
M10	3/8	234	470	15	080090010
M12	1/2	274	690	15	080090012
M14	9/16	342	940	1	080090014
M16	5/8	372	1290	1	080090016
M18	11/16	406	1660	1	080090018
M20	3/4	406	2130	1	080090020
M22	7/8	466	2630	1	080090022
M24	1"	486	3060	1	080090024
M27	1 1/8	510	4000	1	080090027
M30	1 3/16	566	4860	1	080090030

8009TZ

jaw and jaw turnbuckles,
pipe bodies, DIN 1478
galvanized



TECHNICAL DATA

- safety coefficient: 4
- LABORATORY TESTS
- chemical analysis
- tensile test

AVAILABLE CERTIFICATES

- Technical Product Specifications
- Test Report UNI EN10204 type 2.2
- CE Declaration of Conformity

Ø mm	Ø "	WFL kg		
M12	1/2	690	10	080090512
M16	5/8	1290	1	080090516
M20	3/4	2130	1	080090520
M24	1	3060	1	080090524
M30	1.3/16	4860	1	080090530

8010Z

eye and jaw turnbuckles,
galvanized

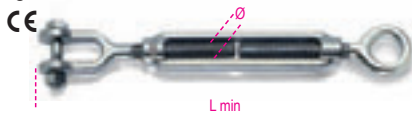

TECHNICAL DATA

- safety coefficient: 4
- LABORATORY TESTS
- chemical analysis
- tensile test

AVAILABLE CERTIFICATES

- Technical product specifications
- Test report UNI EN10204 type 2.2
- CE Declaration of Conformity

Ø mm	Ø "	L min mm	WFL kg		
M8	5/16	175	300	20	080100008
M10	3/8	215	470	15	080100010
M12	1/2	250	690	10	080100012
M14	9/16	299	940	10	080100014
M16	5/8	331	1290	1	080100016
M18	11/16	382	1660	1	080100018
M20	3/4	382	2130	1	080100020
M22	7/8	433	2630	1	080100022
M24	1"	461	3060	1	080100024
M27	1 1/8	492	4000	1	080100027
M30	1 3/16	529	4860	1	080100030



8105

eye and eye turnbuckles
high tensile steel, hot dip galvanized

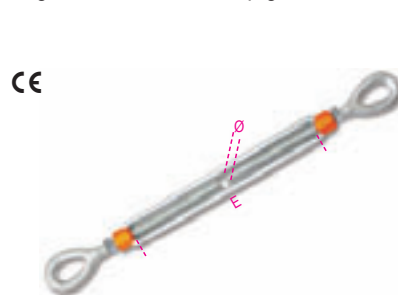

TECHNICAL DATA

- safety factor: 5
- heat treatment, body: normalizing
- heat treatment, eyes: hardening and tempering
- LABORATORY TESTS
- chemical analysis
- tensile test
- proof load test 2 x WFL

AVAILABLE CERTIFICATES

- Technical product specifications
- Test report UNI EN10204 type 2.2

ØxE "	≈ mm	WFL kg		
3/8x6	M10x150	540	5	081050010
1/2x9	M12x230	1000	5	081050012
5/8x9	M16x230	1590	2	081050016
3/4x9	M20x230	2360	2	081050020
7/8x12	M22x300	3270	1	081050022
1"x6	M24x150	4540	1	081050024
1"x12	M24x300	4540	1	081050025
1 1/4x12	M33x300	6890	1	081050031

Other sizes available upon request

8109

jaw and jaw turnbuckles
high tensile steel, hot dip galvanized

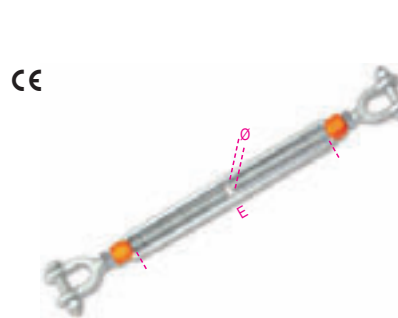

TECHNICAL DATA

- safety factor: 5
- heat treatment, body: normalizing
- heat treatment, jaws: hardening and tempering
- LABORATORY TESTS
- chemical analysis
- tensile test

AVAILABLE CERTIFICATES

- Technical product specifications
- Test report UNI EN10204 type 2.2

ØxE "	≈ mm	WFL kg		
3/8x6	M10x150	540	5	081090010
1/2x9	M12x230	1000	5	081090012
5/8x9	M16x230	1590	2	081090016
3/4x9	M20x230	2360	2	081090020
7/8x12	M22x300	3270	1	081090022
1"x6	M24x150	4540	1	081090024
1"x12	M24x300	4540	1	081090025
1 1/4x12	M33x300	6890	1	081090031
1 1/4x24	M33x610	6890	1	081090033

Other sizes available upon request

8016U

wire rope clips EN 13411-5, type A
malleable cast iron body
galvanized

CE

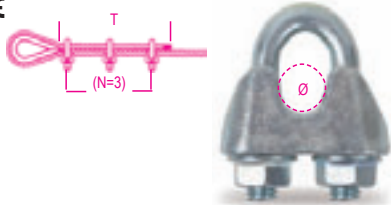

EN 13411-5

TECHNICAL DATA

- traceability code
- LABORATORY TESTS
- chemical analysis
- torque test

AVAILABLE CERTIFICATES

- Technical product specifications
- Test report UNI EN10204 type 2.2
- Manufacturer's Certificate UNI EN13411-5
- CE Certificate of Conformity

Ø mm	Ø "	N x T	Nm		
5	3/16	3x156	2,0	300	080160605
6,5	1/4	3x192	3,5	150	080160606
8	5/16	4x320	6	70	080160608
10	3/8	4x320	9	10	080160610
12	1/2	4x384	20	25	080160612
14	9/16	4x448	33	15	080160614
16	5/8	4x512	49	10	080160616
19	3/4	4x512	68	10	080160619
22	7/8	5x680	107	10	080160622
26	1"	5x760	147	5	080160626
30	1 1/8	6x984	212	5	080160630
34	1 1/4	6x1080	296	5	080160634
40	1 1/2	6x1176	363	5	080160640

WITH BATCH
DELIVERY NUMBER

8016

wire rope clips,
hot forged steel body,
galvanized

CE

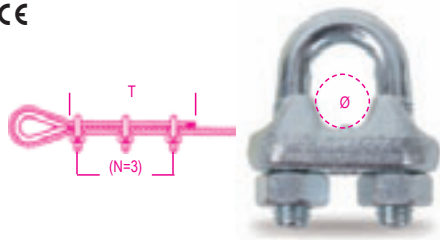

TECHNICAL DATA

- chemical analysis
- torque test

AVAILABLE CERTIFICATES

- Technical product specifications
- Test report UNI EN10204 type 2.2
- CE Certificate of Conformity

Ø mm	Ø "	N x T	Nm		
3	1/8	3x80	1,53	500	080160003
5	3/16	3x110	3,02	300	080160005
6	1/4	3x120	5,19	200	080160006
8	5/16	5x210	5,19	150	080160008
10	3/8	5x240	12,54	70	080160010
11	7/16	5x260	12,54	70	080160011
12-13	1/2	5x300	24,76	40	080160013
14	9/16	5x295	24,76	35	080160014
16	5/8	5x335	24,76	30	080160016
18	11/16	5x380	42,42	30	080160018
20	3/4	5x540	42,42	30	080160020
22	7/8	7x595	42,42	25	080160022
24-26	1"	7x700	67,56	15	080160026
28	1 1/16	8x840	67,56	5	080160028
30-32	1 1/8	8x990	67,56	5	080160030
34-36	1 1/4	8x1155	105,80	4	080160034
38-40	1 1/2	8x1320	105,80	2	080160040
48-50	2"	8x1500	206	1	080160050

special packaging

Ø mm	"			
3	1/8	100		1 080160703
5	3/16	50		1 080160705
6	1/4	50		1 080160706
8	5/16	30		1 080160708
10	3/8	30		1 080160710
11	7/16	25		1 080160711
12-13	1/2	15		1 080160713

8016DA

wire rope clips with high nuts,
hot forged steel body,
galvanized

CE

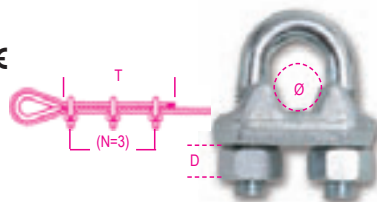

LABORATORY TESTS

- chemical analysis
- torque test

AVAILABLE CERTIFICATES

- Technical product specifications
- Test report UNI EN10204 type 2.2
- CE Certificate of Conformity

Ø mm	N x T	Nm	D mm		
5	3x110	3,02	5	300	080160093
6	3x120	5,19	6	200	080160092
8	5x210	5,19	6	150	080160098
10	5x240	12,54	8	70	080160096

8016DF

wire rope clips with flanged nuts,
hot forged steel body,
galvanized

CE

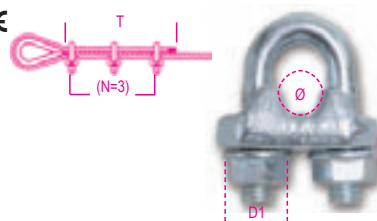

LABORATORY TESTS

- chemical analysis
- torque test

AVAILABLE CERTIFICATES

- Technical product specifications
- Test report UNI EN10204 type 2.2
- CE Certificate of Conformity

Ø mm	N x T	Nm	D1 mm		
6	3x120	5,19	14,2	200	080160066
8	5x210	5,19	14,2	150	080160068
10	5x240	12,54	17,9	70	080160070

8016FR

wire rope clips,
cold pressed steel body,
galvanized

CE

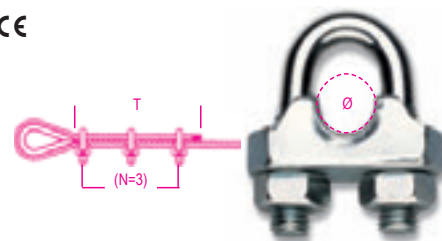

LABORATORY TESTS

- chemical analysis
- AVAILABLE CERTIFICATES
- Technical product specifications
- Test report UNI EN10204 type 2.2
- CE Certificate of Conformity

Ø mm	Ø mm	N x T	Nm		
3	1/8	3x80	1,25	500	080160253
5	3/16	3x110	2,46	300	080160255
6	1/4	3x120	4,24	200	080160256
8	5/16	5x210	4,24	150	080160258
10	3/8	5x240	10,20	70	080160260
12-13	1/2	5x300	20,11	40	080160263

8018E

wire rope clips, ENEL type,
hot forged steel body, hot-dip galvanized
U-bolts and nuts with chemical galv. protection



LABORATORY TESTS

- chemical analysis
- AVAILABLE CERTIFICATES
- Technical product specifications
- Test report UNI EN10204 type 2.2

Ø mm	A mm	L mm	Nm		
4÷6	M6	34	4,24	100	080180001

8018T

wire rope clips, TELECOM type
malleable cast iron body
galvanized



RUM-MU-21:1980

LABORATORY TESTS

- chemical analysis
- AVAILABLE CERTIFICATES
- Technical product specifications
- Test report UNI EN10204 type 2.2

Ø mm	A mm	L mm	Nm		
8÷10	M8	42	10,20	200	080180003

8317DZ

duplex wire rope clips
galvanized



AVAILABLE CERTIFICATES

- Test report UNI EN10204 type 2.2

Ø mm	L mm	L1 mm		
2	30	14	50	083170002
3	35	15	50	083170003
4	40	18	50	083170004
5	50	21	25	083170005
6	60	25	20	083170006
8	76	33	10	083170008
10	95	37	10	083170010

8317SZ

simplex wire rope clips
galvanized

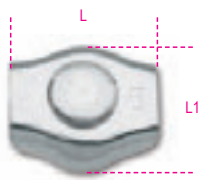

AVAILABLE CERTIFICATES

- Test report UNI EN10204 type 2.2

Ø mm	L mm	L1 mm		
2	15	14	100	083170102
3	18	16	100	083170103
4	20	19	100	083170104
5	24	23	50	083170105
6	30	27	30	083170106
8	36	34	20	083170108
10	42	37	10	083170110

8020

thimbles, italian light type,
galvanized

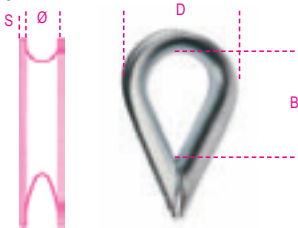

AVAILABLE CERTIFICATES

- Technical product specifications
- Test report UNI EN10204 type 2.2

Ø mm	S mm	B mm	D mm		
2-3	0,8	20	20	350	080200003
4	1,0	22	21	300	080200004
5	1,0	23	24	300	080200005
6	1,0	27	29	200	080200006
8	1,2	33	33	180	080200008
10	1,5	40	39	100	080200010
12	1,8	44	46	160	080200012
14	2,0	49	50	100	080200014
16	2,0	57	59	150	080200016
18	2,5	68	69	100	080200018
20	3,0	78	77	70	080200020
22	3,0	88	84	60	080200022
24	3,5	92	91	40	080200025

special packaging

Ø mm	S mm			
2-3	0,8	150	1	080200703
4	1,0	150	1	080200704
5	1,0	100	1	080200705
6	1,0	100	1	080200706
8	1,2	50	1	080200708
10	1,5	30	1	080200710

8021

thimbles, heavy type,
galvanized

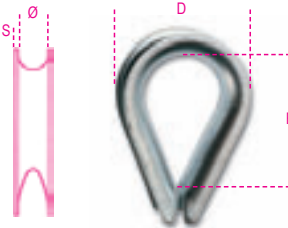

AVAILABLE CERTIFICATES

- Technical product specifications
- Test report UNI EN10204 type 2.2

Ø mm	S mm	B mm	D mm		
2-3	0,6	15	16	150	080210003
5	1,7	29	28	120	080210005
6	1,8	33	30	100	080210006
8	2,5	36	37	100	080210008
10	2,5	42	43	80	080210010
12	2,5	48	50	100	080210012
14	2,7	58	57	70	080210014
16	3,0	61	62	50	080210016
18	3,5	71	71	70	080210018
20	4,0	79	79	60	080210020
22	4,0	87	84	50	080210022
24	4,0	93	92	40	080210024
26	4,0	103	103	35	080210026
28	5,0	107	116	1	080210028
30	5,0	118	121	1	080210030
32	5,5	138	135	1	080210032
35	6,0	140	147	1	080210035
40	6,0	173	170	1	080210040

8025

lifting LARGE DEE shackles,
hot forged carbon steel,
galvanized

CE

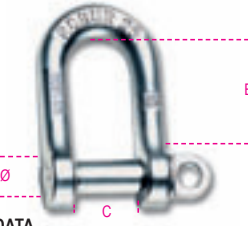

GRADO 4

TECHNICAL DATA

- safety factor: 5
- heat treatment: normalizing
- traceability code

LABORATORY TESTS

- chemical analysis
- metallographic analysis
- tensile test

AVAILABLE CERTIFICATES

- Technical product specifications
- Test report UNI EN10204 type 2.2
- Inspection certificate UNI EN10204 type 3.1
- CE Declaration of Conformity

Ø mm	B x C mm	WLL kg		
5	3/16 21x10	70	250	080250005
6	1/4 25x12	100	250	080250006
8	5/16 33x16	250	150	080250008
10	3/8 42x20	400	180	080250010
11	7/16 46x22	500	130	080250011
12	1/2 50x24	600	100	080250012
14	9/16 57x28	800	70	080250014
16	5/8 61x32	1000	15	080250016
18	11/16 65x36	1300	15	080250018
20	3/4 70x40	1600	10	080250020
22	7/8 74x44	2000	10	080250022
25	1" 80x48	2800	5	080250025

special packaging

Ø mm	"			
5	3/16	25	1	080250705
6	1/4	25	1	080250706
8	5/16	25	1	080250708
10	3/8	15	1	080250710
11	7/16	12	1	080250711
12	1/2	12	1	080250712
14	9/16	10	1	080250714

8026A

lifting DEE shackles,
hot forged carbon steel,
UNI 1947 type A, galvanized

CE

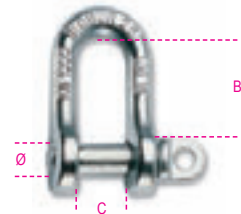

GRADO 4

TECHNICAL DATA

- safety factor: 5
- heat treatment: normalizing
- traceability code

LABORATORY TESTS

- chemical analysis
- metallographic analysis
- tensile test

AVAILABLE CERTIFICATES

- Technical product specifications
- Test report UNI EN10204 type 2.2
- Inspection certificate UNI EN10204 type 3.1
- CE Declaration of Conformity

Ø mm	"	B x C mm	WLL kg		
12	1/2	42x20	630	35	080260012
14	9/16	46x22	800	30	080260014
16	5/8	50x24	1000	20	080260016
18	11/16	54x26	1300	15	080260018
20	3/4	58x28	1600	10	080260020
22	7/8	69x32	2000	10	080260022
25	1"	79x36	2500	5	080260025
28	1 1/8	90x40	3150	2	080260028
32	1 1/4	100x45	4000	2	080260032
36	1 3/8	110x50	5000	1	080260036
40	1 9/16	120x55	6300	1	080260040
42	1 5/8	131x60	8000	1	080260042
45	1 3/4	143x65	10000	1	080260045
50	2"	155x70	12500	1	080260050

 Robur

8026R

straight shackles with screw collar pin, high-tensile alloy steel, GRADE 6, hot-dipped galvanized body

CE

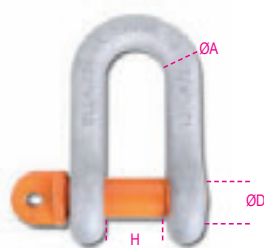

EN 13889
GRADE 6

TECHNICAL DATA

- minimum safety factor: 6
- heat treatment: hardening and tempering
- traceability code on both pin and body

LABORATORY TESTS

- chemical analysis
- metallographic analysis
- tensile test
- fatigue test (min. 20,000 cycles)
- proof load test (2 x WLL)

AVAILABLE CERTIFICATES

- Technical Product Specifications
- Test Report UNI EN10204 type 2.2
- Inspection Certificate UNI EN10204 type 3.1
- CE Declaration of Conformity

ØA	ØD	H	WLL		
mm	mm (")	mm	kg		
13	16	21	2000	5	080260212
16	19	27	3250	3	080260216
19	22	32	4750	2	080260219
22	25	37	6500	2	080260222

8531

dee FISHING shackles, hot-dip galvanized

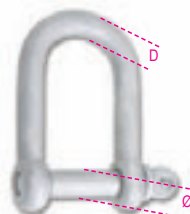

AVAILABLE CERTIFICATES

- Test report UNI EN10204 type 2.2

Ø	D	WFL		
mm	mm	kg		
20	18	1600	1	085310018
22	20	2500	1	085310020

8532

dee FISHING shackles with square head screw pin, black painted



AVAILABLE CERTIFICATES

- Test report UNI EN10204 type 2.2

Ø	D	WFL		
mm	mm	kg		
20	20	1600	1	085320020
22	22	2500	1	085320022

8028

lifting BOW shackles, hot forged carbon steel, galvanized

CE

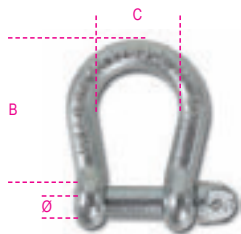

GRADO 4

TECHNICAL DATA

- safety factor: 5
- heat treatment: normalizing
- traceability code

LABORATORY TESTS

- chemical analysis
- metallographic analysis
- tensile test

AVAILABLE CERTIFICATES

- Technical product specifications
- Test report UNI EN10204 type 2.2
- Inspection certificate UNI EN10204 type 3.1
- CE Declaration of Conformity

Ø	B x C	WLL		
mm	mm	kg		
5	3/16	20x16	80	100 080280105
6	1/4	24x20	100	70 080280106
8	5/16	32x24	200	35 080280108
10	3/8	40x33	300	25 080280110
11	7/16	44x36	400	15 080280111
12	1/2	48x39	500	15 080280112
14	9/16	56x46	600	7 080280114
16	5/8	64x46	800	10 080280116
18	11/16	71x59	950	5 080280118
20	3/4	80x65	1100	5 080280120
22	7/8	88x72	1500	5 080280122
25	1"	100x81	2000	2 080280125
28	1.1/8	112x91	2600	1 080280128
32	1.1/4	128x104	3200	1 080280132
38	1.1/2	152x124	4500	1 080280138

8029R - 8029

bow shackles with screw collar pins, high-tensile alloy steel, GRADE 6, hot-dipped galvanized body

CE



EN 13889
GRADO 6

TECHNICAL DATA

- minimum safety factor: 6
- heat treatment: hardening and tempering
- traceability code on pin and body

LABORATORY TESTS

- chemical analysis
- metallographic analysis
- tensile test
- fatigue test (min. 20,000 cycles)
- proof load test (2 x WLL)

AVAILABLE CERTIFICATES

- Technical Product Specifications
- Test Report UNI EN10204 type 2.2
- Inspection Certificate UNI EN10204 type 3.1
- CE Declaration of Conformity

	ØA	ØD	WLL		
	mm	mm (")	kg		
8029R	6	8 (5/16)	500	20	080290106
8029R	8	10 (3/8)	750	15	080290108
8029R	10	11 (7/16)	1000	15	080290110
8029R	11	13 (1/2)	1500	10	080290111
8029R	13	16 (5/8)	2000	8	080290112
8029R	16	19 (3/4)	3250	5	080290116
8029R	19	22 (7/8)	4750	2	080290120
8029R	22	25 (1")	6500	2	080290122
8029R	26	28 (1.1/8)	8500	1	080290124
8029R	29	32 (1.1/4)	9500	1	080290128
8029R	32	35 (1.3/8)	12000	1	080290132
8029R	35	38 (1.1/2)	13500	1	080290135
8029R	38	42 (1.5/8)	17000	1	080290138
8029R	45	50 (2")	25000	1	080290145

	ØA	ØD	WLL		
	mm	mm	kg		
* 8029	50	57 (2.1/4)	35000	1	080290057
* 8029	57	65	42500	1	080290065
		(2.9/16)			
* 8029	65	70 (2.3/4)	55000	1	080290070

*Sizes not included in EN13889 standard

Robur

Robur

8032

bow shackles with square sunken hole screw pin,
high-tensile alloy steel, GRADE 6,
hot-dip galvanized body

CE

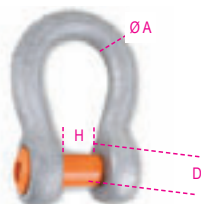

GRADE 6

TECHNICAL DATA

- minimum safety factor: 6
- heat treatment: hardening and tempering
- traceability code on pin and body

LABORATORY TESTS

- chemical analysis
- metallographic analysis
- tensile test
- fatigue test (min. 20,000 cycles)
- proof load test (2 x WLL)

AVAILABLE CERTIFICATES

- Technical Product Specifications
- Test Report UNI EN10204 type 2.2
- Inspection Certificate UNI EN10204 type 3.1
- CE Declaration of Conformity

ØA	ØD	H	WLL		
mm	mm (")	mm	kg		
13	16 (5/8)	21	2000	5	080320012
16	19 (3/4)	27	3250	3	080320016
19	22 (7/8)	32	4750	2	080320020
22	25 (1)	37	6500	2	080320022

8031R - 8031

bow shackles with safety bolt, EN13889
high-tensile alloy steel, GRADE 6,
hot-dip galvanized body

CE



EN 13889

GRADO 6

TECHNICAL DATA

- minimum safety factor: 6
- heat treatment: hardening and tempering
- traceability code on pin and body

LABORATORY TESTS

- chemical analysis
- metallographic analysis
- tensile test
- fatigue test (min. 20,000 cycles)
- proof load test (2 x WLL)

AVAILABLE CERTIFICATES

- Technical Product Specifications
- Test Report UNI EN10204 type 2.2
- Inspection Certificate UNI EN10204 type 3.1
- CE Declaration of Conformity

ØA	ØD	H	WLL		
mm	mm (")	mm	kg		
8031R	13	16 (5/8)	21	2000	5 080310112
8031R	16	19 (3/4)	27	3250	3 080310116
8031R	19	22 (7/8)	32	4750	2 080310120
8031R	22	25 (1)	37	6500	2 080310122
8031R	26	28 (1.1/8)	43	8500	1 080310124

8031R	29	32 (1.1/4)	48	9500	1 080310128
8031R	32	35 (1.3/8)	53	12000	1 080310132
8031R	35	38 (1.1/2)	59	13500	1 080310135
8031R	38	42 (1.5/8)	62	17000	1 080310138
8031R	45	50 (2)	75	25000	1 080310145

Ø	D	H	WLL		
mm	"	mm	kg		
* 8031	65	70 (2.3/4)	105	55000	1 080310070

DIN 580 / 582 : 2010				
	WLL I	WLL II	WLL III	WLL IV
	kg	kg	kg	kg
* M6	90	90	90	90
M8	140	140	140	95
M10	230	230	230	160
* M12	340	340	340	240
* M14	480	480	480	335
* M16	700	700	700	495
* M18	930	930	930	655
* M20	1200	1200	1200	845
* M22	1450	1450	1450	1025
* M24	1800	1800	1800	1270
* M27	2400	2400	2400	1695
* M30	3200	3200	3200	2260
* M33	3900	3900	3900	2755
* M36	4600	4600	4600	3250
* M42	6300	6300	6300	4455
* M48	8600	8600	8600	6080
* M56	11500	11500	11500	8130
* M64	16000	15500	16000	11310

8040EZ

lifting eye bolts, DIN 580
galvanized

CE



DIN 580:2010-09

TECHNICAL DATA

- safety factor: 6
 - heat treatment: normalizing
 - traceability code
- ### LABORATORY TESTS
- chemical analysis
 - metallographic analysis
 - tensile test
- ### AVAILABLE CERTIFICATES
- Technical product specifications
 - Test report UNI EN10204 type 2.2
 - Inspection certificate UNI EN10204 type 3.1
 - CE Declaration of Conformity

Ø	E	WLL		
mm	mm	kg		
* M6	1	11	90	60 080400406
M8	1,25	13	140	60 080400408
M10	1,5	17	230	50 080400410
M12	1,75	20,5	340	25 080400412
* M14	2	20,5	480	25 080400414
M16	2	27	700	15 080400416
* M18	2,5	27	930	15 080400418
M20	2,5	30	1200	10 080400420
* M22	2,5	30	1450	10 080400422
M24	3	36	1800	5 080400424
* M27	3	41	2400	5 080400427
M30	3,5	45	3200	2 080400430
* M33	3,5	54	3900	2 080400433
* M33F	2	54	3900	2 080400434
M36	4	54	4600	2 080400436
* M36F	3	54	4600	2 080400437
M42	4,5	63	6300	1 080400442
* M42F	3	63	6300	1 080400443
M48	5	68	8600	1 080400448
* M48F	3	68	8600	1 080400449
M56	5,5	78	11500	1 080400456
* M56F	4	78	11500	1 080400457
M64	6	90	16000	1 080400464
* M64F	4	90	16000	1 080400465

*Sizes not included in DIN standard

8040EN

lifting eye bolts, DIN 580
self-coloured

CE



DIN 580:2010-09

TECHNICAL DATA

- safety factor: 6
- heat treatment: normalizing
- traceability code

LABORATORY TESTS

- chemical analysis
- metallographic analysis
- tensile test

AVAILABLE CERTIFICATES

- Technical product specifications
- Test report UNI EN10204 type 2.2
- Inspection certificate UNI EN10204 type 3.1
- CE Declaration of Conformity

Ø	E	WLL		
mm	mm	kg		
* M6	1	11	90	60 080400306
M8	1,25	13	140	60 080400308
M10	1,5	17	230	50 080400310
M12	1,75	20,5	340	25 080400312
* M14	2	20,5	480	25 080400314
M16	2	27	700	15 080400316
* M18	2,5	27	930	15 080400318
M20	2,5	30	1200	10 080400320
* M22	2,5	30	1450	10 080400322
M24	3	36	1800	5 080400324
* M27	3	41	2400	5 080400327
M30	3,5	45	3200	2 080400330
* M33	3,5	54	3900	2 080400333
* M33F	2	54	3900	2 080400334
M36	4	54	4600	2 080400336
* M36F	3	54	4600	2 080400337
M42	4,5	63	6300	1 080400342
* M42F	3	63	6300	1 080400343
M48	5	68	8600	1 080400348
* M48F	3	68	8600	1 080400349
M56	5,5	78	11500	1 080400356
* M56F	4	78	11500	1 080400357
M64	6	90	16000	1 080400364
* M64F	4	90	16000	1 080400365

*Sizes not included in DIN standard

DIN 580 / 582 : 2010				
	WLL I	WLL II	WLL III	WLL IV
	kg	kg	kg	kg
* M6	90	90	90	90
M8	140	140	140	95
M10	230	230	230	160
M12	340	340	340	240
* M14	480	480	480	335
M16	700	700	700	495
* M18	930	930	930	655
M20	1200	1200	1200	845
* M22	1450	1450	1450	1025
M24	1800	1800	1800	1270
* M27	2400	2400	2400	1665
M30	3200	3200	3200	2260
* M33	3900	3900	3900	2755
M36	4800	4800	4800	3390
M42	6300	6300	6300	4455
M48	8600	8600	8600	6090
M56	11500	11500	11500	8130
M64	16000	15950	16000	11310

8042EZ

lifting eye nuts, DIN 582
galvanized

CE

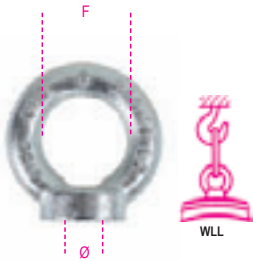

DIN 582:2010-09

TECHNICAL DATA

- safety factor: 6
- heat treatment: normalizing
- traceability code

LABORATORY TESTS

- chemical analysis
- metallographic analysis
- tensile test

AVAILABLE CERTIFICATES

- Technical product specifications
- Test report UNI EN10204 type 2.2
- Inspection certificate UNI EN10204 type 3.1
- CE Declaration of Conformity

Ø	W	F	WLL		
mm	mm	mm	kg		
* M6	1	14	90	60	080420406
M8	1,25	20	140	60	080420408
M10	1,5	25	230	50	080420410
M12	1,75	30	340	30	080420412
* M14	2	30	480	30	080420414
M16	2	35	700	20	080420416
* M18	2,5	35	930	20	080420418
M20	2,5	40	1200	15	080420420
* M22	2,5	40	1450	15	080420422
M24	3	50	1800	5	080420424
* M27	3	55	2400	5	080420427
M30	3,5	60	3200	3	080420430
M36	4	70	4600	2	080420436
* M36F	3	70	4600	2	080420437
M42	4,5	80	6300	1	080420442
* M42F	3	80	6300	1	080420443
M48	5	90	8600	1	080420448
* M48F	3	90	8600	1	080420449

*Sizes not included in DIN standard

8042EN

lifting eye nuts, DIN 582
self-coloured

CE



DIN 582:2010-09

TECHNICAL DATA

- safety factor: 6
- heat treatment: normalizing
- traceability code

LABORATORY TESTS

- chemical analysis
- metallographic analysis
- tensile test

AVAILABLE CERTIFICATES

- Technical product specifications
- Test report UNI EN10204 type 2.2
- Inspection certificate UNI EN10204 type 3.1
- CE Declaration of Conformity

Ø	W	F	WLL		
mm	mm	mm	kg		
* M6	1	14	90	60	080420306
M8	1,25	20	140	60	080420308
M10	1,5	25	230	50	080420310
M12	1,75	30	340	30	080420312
* M14	2	30	480	30	080420314
M16	2	35	700	20	080420316
* M18	2,5	35	930	20	080420318
M20	2,5	40	1200	15	080420320
* M22	2,5	40	1450	15	080420322
M24	3	50	1800	5	080420324
* M27	3	55	2400	5	080420327
M30	3,5	60	3200	3	080420330
M36	4	70	4600	2	080420336
* M36F	3	70	4600	2	080420337
M42	4,5	80	6300	1	080420342
* M42F	3	80	6300	1	080420343
M48	5	90	8600	1	080420348
* M48F	3	90	8600	1	080420349

*Sizes not included in DIN standard



8044

lifting eye nuts, UNI 2948
self-coloured

CE



UNI 2948

TECHNICAL DATA

- safety factor: 4
- heat treatment: normalizing
- traceability code

LABORATORY TESTS

- chemical analysis
- metallographic analysis
- tensile test

AVAILABLE CERTIFICATES

- Technical product specifications
- Test report UNI EN10204 type 2.2
- Inspection certificate UNI EN10204 type 3.1
- CE Declaration of Conformity

Ø	W	WLL		
mm	mm	kg		
M8	1,25	80	4	080440008
M10	1,5	160	4	080440010
M12	1,75	250	4	080440012
M14	2	250	2	080440014
M16	2	400	2	080440016
M20	2,5	630	2	080440020
M24	3	1000	2	080440024

8041

lifting eyebolts,
high-tensile alloy steel

CE

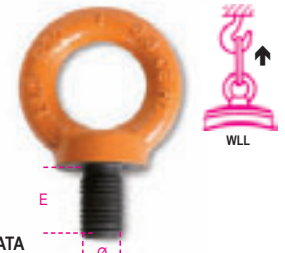

TECHNICAL DATA

- safety factor: 4
- heat treatment: hardening and tempering
- traceability code

LABORATORY TESTS

- chemical analysis
- metallographic analysis
- tensile test
- fatigue test (20,000 cycles)
- proof load test (100% of batch)

AVAILABLE CERTIFICATES

- Technical product specifications
- Test report UNI EN10204 type 2.2
- Inspection certificate UNI EN10204 type 3.1
- CE Declaration of Conformity

Ø	W	E	WLL		
mm	mm	mm	kg		
* M8	1,25	13	600	10	080410208
* M10	1,5	17	800	6	080410210
* M12	1,75	20,5	1300	4	080410212
* M16	2	27	3200	2	080410216
* M20	2,5	30	4800	2	080410220
* M24	3	36	6500	2	080410224
* M30	3,5	45	9500	1	080410230

(*) Dimensional specifications DIN 580:2010
WLL increased according to Robur Technical Product Specifications

8043

lifting eye nuts,
high-tensile alloy steel

CE

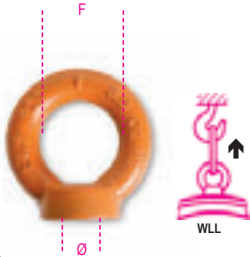

TECHNICAL DATA

- safety factor: 4
- heat treatment: hardening and tempering
- traceability code

LABORATORY TESTS

- chemical analysis
- metallographic analysis
- tensile test
- fatigue test (20,000 cycles)
- proof load test (100% of batch)

AVAILABLE CERTIFICATES

- Technical product specifications
- Test report UNI EN10204 type 2.2
- Inspection certificate UNI EN10204 type 3.1
- CE Declaration of Conformity

Ø mm	F mm	WLL kg		
* M8	1,25	20	600	10 080430208
* M10	1,50	25	800	6 080430210
* M12	1,75	30	1300	4 080430212
* M16	2	35	3200	2 080430216
* M20	2,5	40	4800	2 080430220
* M24	3	50	6500	2 080430224
* M30	3,5	60	9500	1 080430230

(*) Dimensional specifications DIN 582:2010

WLL increased according to Robur Technical Product Specifications

8049

adjustable lifting eyebolts,
double swivel ring,
high-tensile alloy steel

CE

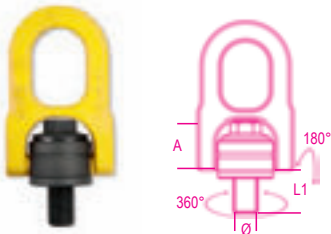

TECHNICAL DATA

- safety factor: 5
- heat treatment: hardening and tempering
- traceability code

LABORATORY TESTS

- chemical analysis
- metallographic analysis
- tensile test
- fatigue test (20,000 cycles)

AVAILABLE CERTIFICATES

- Technical product specifications
- Test report UNI EN10204 type 2.2
- Inspection certificate UNI EN10204 type 3.1
- CE Declaration of Conformity

Ø mm	A mm	L1 mm	WLL kg		
M8	31,5	14	300	1	080490008
M10	31,5	17	600	1	080490010
M12	31,5	21	1000	1	080490012
M16	45	27	1600	1	080490016
M20	45	30	2500	1	080490020
M24	60,5	36	4000	1	080490024
M30	60,5	45	6300	1	080490030

8049 WLL (t)

	A°	M8	M10	M12	M16	M20	M24	M30
	0°	0,3	0,6	1	1,6	2,5	4	6,3
	90°	0,6	1,2	2	3,2	5	8	12,6
	90°	0,3	0,6	1	1,6	2,5	4	6,3
	45°	0,4	0,8	1,4	2,2	3,5	5,6	8,8
	45°	0,3	0,6	1	1,6	2,5	4	6,3
	60°	0,3	0,6	1	1,6	2,3	4	6,3

8048

eye tie rods right thread
self-coloured



UNI 6058

AVAILABLE CERTIFICATES

- Technical product specifications
- Test report UNI EN10204 type 2.2

ØxL mm	F mm		
M8x50	6	1	080480108
M8x65	6	1	080480109
M10x80	8	1	080480110
M10x100	8	1	080480210
M10x130	8	1	080480111
M12x70	10	1	080480212
M12x95	10	1	080480112
M12x125	10	1	080480113
M14x110	12	1	080480114
M16x100	14	1	080480115
M16x130	14	1	080480116
M18x150	16	1	080480118
M20x160	18	1	080480120
M22x180	18	1	080480122
M24x200	20	1	080480124
M27x220	22	1	080480127

8074

carabine hooks,
galvanized

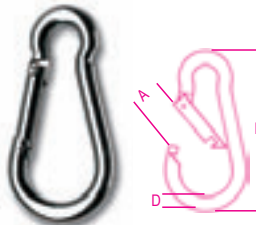

DIN 5299

TECHNICAL DATA

- safety factor: 4

AVAILABLE CERTIFICATES

- Technical product specifications
- Test report UNI EN10204 type 2.2

DxL mm	A mm	WFL kg		
* 4x40	6	20	100	080740040
5x50	7	30	100	080740050
6x60	8	40	100	080740060
7x70	9	60	50	080740070
8x80	11	75	50	080740080
9x90	12	100	25	080740090
10x100	13	120	25	080740100
11x120	16	140	20	080740101

DxL mm	A mm	WFL kg		
12x140	22	140	15	080740102
13x160	24	200	10	080740103
* 14x180	32	250	5	080740104

8080

quick links,
galvanized

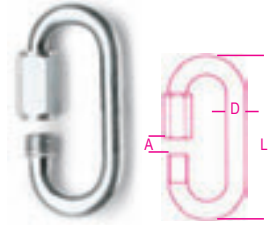

TECHNICAL DATA

- safety factor: 4

AVAILABLE CERTIFICATES

- Technical product specifications
- Test report UNI EN10204 type 2.2

DxL mm	A mm	WFL kg		
3,5x36	5	20	100	080800003
4x40	6	30	100	080800004
5x49	6	50	100	080800005
6x57	8	60	100	080800006
7x66	8	100	50	080800007
8x74	11	140	50	080800008
9x80	11	160	25	080800009
10x89	11	220	25	080800010
12x105	15	300	20	080800012

8082

rings
galvanized steel

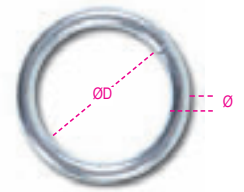

Ø mm	ØD mm		
4	20	50	080820004
5	30	20	080820005
6	40	10	080820006
7	50	5	080820007
8	60	5	080820008

8083

S-hooks
galvanized steel



Ø mm	L mm		
3	33	40	080830003
4	40	30	080830004
5	47	20	080830005
6	59	15	080830006
8	79	5	080830008

8114

eye and eye swivels,
italian "Marche" type,
carbon steel, galvanized

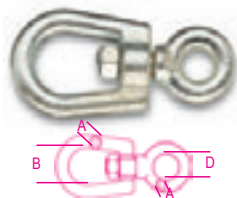

TECHNICAL DATA

• safety factor: 4

• traceability code

LABORATORY TESTS

• tensile test

AVAILABLE CERTIFICATES

• Technical product specifications

• Test report UNI EN10204 type 2.2

A	B	D	WFL		
mm	mm	mm	kg		
8	30	16	250	1	081140008
10	38	18	300	1	081140010
12	42	20	650	1	081140012
14	48	22	820	1	081140014
16	57	24	1000	1	081140016
18	64	26	1600	1	081140018
20	72	30	2000	1	081140020
22	80	34	2500	1	081140022

8116

eye and eye swivels,
carbon steel, galvanized

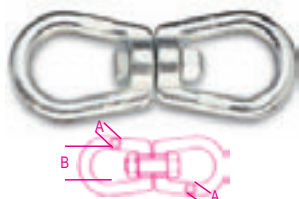

TECHNICAL DATA

• safety factor: 4

• traceability code

LABORATORY TESTS

• tensile test

AVAILABLE CERTIFICATES

• Technical product specifications

• Test report UNI EN10204 type 2.2

A	B	WFL		
mm	mm	kg		
6	23	140	1	081160006
8	30	250	1	081160008
10	38	300	1	081160010
12	42	650	1	081160012
14	48	820	1	081160014
16	57	1000	1	081160016
18	64	1600	1	081160018
20	72	2000	1	081160020
22	80	2500	1	081160022

8120

Genovese chains
for static connections,
galvanized



TECHNICAL DATA

• safety factor: 4

AVAILABLE CERTIFICATES

• Technical product specifications

• Test report UNI EN10204 type 2.2

Ø mm	nr	WFL		
mm		kg	m	
1,6	12	15	150	1 081200016
2,2	14	25	75	1 081200022
2,7	16	37	75	1 081200027
3,0	17	55	75	1 081200030
3,4	18	75	60	1 081200034
3,8	19	100	50	1 081200038
4,4	20	125	40	1 081200044
4,8	21	165	30	1 081200048
5,5	22	185	25	1 081200055
5,8	23	225	25	1 081200058
6,5	24	265	25	1 081200065
7,5	26	350	20	1 081200075
* 8,0	27	400	25	1 081200080
* 10,0	30	625	20	1 081200100
* 12,0	32	900	15	1 081200120

Caution: product NOT designed for lifting purposes

(*) available in COILS

8130

antitheft chains, made of alloy steel,
case-hardened, tempered,
galvanized



Ø mm	L		
mm	mm		
6	800	1	081300068
8	1000	1	081300081
8	1200	1	081300082
10	1500	1	081300105

8130A

anti-theft chains with rings,
made of alloy steel, case-hardened, tempered,
galvanized



Ø mm	L		
mm	mm		
10	900	1	081300209

8131Z

antitheft chains with padlocks



Ø mm	L	8139Z		
mm	mm	Ø mm		
6	800	8	1	081310060
6	800	10	1	081310068
8	1000	10	1	081310081
8	1200	10	1	081310082
10	1500	10	1	081310105

8131DL

disc lock with anti-theft chain 8130A



Ø mm	L		
mm	mm		
10	900	1	081310209

8139DL

motorcycle disc locks,
made of hardened steel, shockproof PVC,
blister-packed

• supplied with 3 keys, signalling cable, case
• suitable for 10mm chains



Ø	L	H		
mm	mm	mm		
14	108	56	1	081390214

8139Z

padlocks for antitheft chains,
zinc alloy bodies

• supplied with 3 mapped keys
• suitable for chains 6, 8, 10 mm

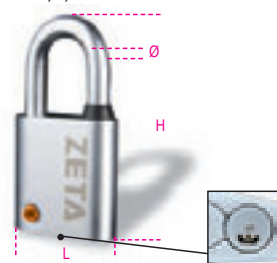

Ø	L	H		
mm	mm	mm		
8	45	90	1	081390008
10	55	98	1	081390009

8139ZCH

3 neutral spare keys
for locks 8139Z



8139ZCH 1 081390909

suitable for locks ø8 and ø10

8302Z

fastening eye bolts,
right thread, galvanized

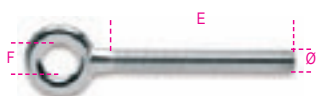

TECHNICAL DATA

• safety factor: 4

AVAILABLE CERTIFICATES

- Technical product specifications
- Test report UNI EN10204 type 2.2

Ø mm	E mm	F mm	WFL kg		
M5	48	8	115	200	083020005
M6	55	10	160	150	083020006
M8	60	12	300	100	083020008
M10	73	14	470	100	083020010
M12	90	17	690	50	083020012

8303Z

fastening hooks
right thread, galvanized



TECHNICAL DATA

• safety factor: 4

AVAILABLE CERTIFICATES

- Technical product specifications
- Test report UNI EN10204 type 2.2

Ø mm	C mm	E mm	WFL kg		
M5	6,0	48	25	150	083030005
M6	8,0	55	45	120	083030006
M8	10,0	60	95	100	083030008
M10	12,5	73	140	70	083030010
M12	16,0	90	220	30	083030012

8381SL

U bolts for pipes, light type,
galvanized

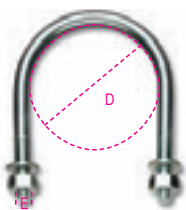

AVAILABLE CERTIFICATES

- Technical product specifications
- Test report UNI EN10204 type 2.2

D mm	D gas mm	E mm		
11	1/8"	M6	100	083810201
14	1/4"	M6	100	083810202
18	3/8"	M6	100	083810203
22	1/2"	M6	100	083810204

D mm	D gas mm	E mm		
27	3/4"	M6	100	083810205
34	1"	M6	100	083810206
43	1 1/4"	M6	100	083810207
49	1 1/2"	M8	50	083810208
61	2"	M8	50	083810209
77	2 1/2"	M8	25	083810210
89	3"	M8	25	083810211
102	3 1/2"	M8	25	083810212
115	4"	M8	25	083810213
168	6"	M10	25	083810218
220	8"	M10	10	083810220

8381SP

U bolts for pipes, heavy type,
galvanized

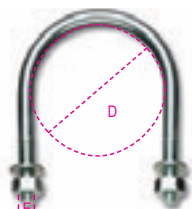

AVAILABLE CERTIFICATES

- Technical product specifications
- Test report UNI EN10204 type 2.2

D mm	D gas mm	E mm		
22	1/2"	M8	100	083810301
27	3/4"	M8	100	083810302
34	1"	M8	100	083810303
43	1 1/4"	M8	100	083810304
49	1 1/2"	M10	50	083810305
61	2"	M10	50	083810306
77	2 1/2"	M10	50	083810307
89	3"	M10	25	083810308
102	3 1/2"	M12	25	083810309
115	4"	M12	25	083810310
168	6"	M16	25	083810315
220	8"	M16	10	083810320
274	10"	M16	1	083810374
408	16"	M24	1	083810508

8383C

square U bolts,
hot galvanized
Flanged nuts

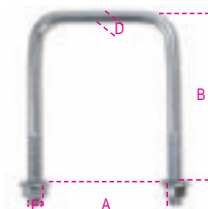

AVAILABLE CERTIFICATES

- Technical Product Specifications
- Test Report UNI EN10204 type 2.2

A mm	E mm	B mm	D mm		
70	M10	110	8,55	130	083830070
80	M10	120	8,55	110	083830080
90	M10	130	8,55	100	083830090
100	M10	155	8,55	90	083830100
120	M10	175	8,55	70	083830120

8383P

plates for square U bolts
hot galvanized

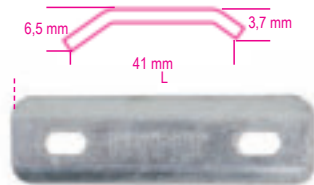

AVAILABLE CERTIFICATES

- Technical product specifications
- Test report UNI EN10204 type 2.2

	L mm		
8383P 150	150	150	083830214
8383C/70-80			
/90-100			
8383P 170	170	120	083830217
8383C/100-120			

8515Z

wire tenders, galvanized

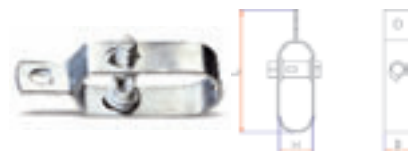

Available Certificates

- Test Report UNI EN10204 type 2.2

D mm	H mm	L mm		
20	25	93	100	085150002
24,5	30	100	100	085150003

8515V

wire tenders,
galvanized and painted



Available Certificates

- Test Report UNI EN10204 type 2.2

D mm	H mm	L mm		
20	25	93	100	085150102
24,5	30	100	100	085150103

8535

fishing hooks,
galvanized

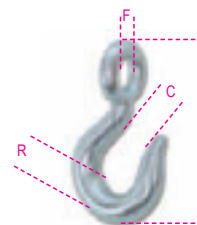

AVAILABLE CERTIFICATES

- Test report UNI EN10204 type 2.2

R mm	C mm	F mm	L mm		
26	27,5	34	156	1	085350006
30	36,5	40	185	1	085350007

8051S

lifting eye hooks,
carbon steel, galvanized

CE



GRADO 4

TECHNICAL DATA

- safety factor: 4
- heat treatment: normalizing
- traceability code

LABORATORY TESTS

- chemical analysis
- metallographic analysis
- tensile test

AVAILABLE CERTIFICATES

- Technical product specifications
- Test report UNI EN10204 type 2.2
- Inspection certificate UNI EN10204 type 3.1
- CE Declaration of Conformity

WLL	C	F		
kg	mm	mm		
250	14	12	10	080510202
500	18	16,5	10	080510205

8052 - 8055S

wire rope eye hooks,
high-tensile alloy steel

CE



EN 1677-2
GRADE 8

TECHNICAL DATA

- safety factor: 4
- heat treatment: hardening and tempering
- traceability code

LABORATORY TESTS

- chemical analysis, metallographic analysis
- tensile test
- fatigue test (min. 20,000 cycles)
- proof load test (2 x WLL)

AVAILABLE CERTIFICATES

- Technical Product Specifications
- Test Report UNI EN10204 type 2.2
- Inspection Certificate UNI EN10204 type 3.1
- CE Declaration of Conformity

WLL	C		
kg	mm		
8052	800	18	1 080520008
8052	1120	22,5	1 080520011
8052	2000	30	1 080520020
8052	3150	36	1 080520031
8052	4000	39,5	1 080520040

WLL	C		
kg	mm		
8055S	5400	32	1 080550145
8055S	8000	41	1 080550170
8055S	11500	53	1 080550215
8055S	16000	58	1 080550260
8055S	22000	78	1 080550320

8057R - 8057

self-locking lifting hooks,
eye type,
high-tensile alloy steel

CE



EN 1677-3

GRADE 8

TECHNICAL DATA

- safety factor: 4
- heat treatment: hardening and tempering
- traceability code

LABORATORY TESTS

- chemical analysis, metallographic analysis
- tensile test
- fatigue test (min. 20,000 cycles)
- proof load test (100% of batch)

AVAILABLE CERTIFICATES

- Technical product specifications
- Test report UNI EN10204 type 2.2
- Inspection certificate UNI EN10204 type 3.1
- CE Declaration of Conformity

WLL	J		
kg	Ø mm	mm	
8057R	2000	7-8	34
8057R	3150	10	44

WLL	J		
kg	Ø mm	mm	
8057	5300	13	54

8058R - 8058

self-locking lifting hooks,
Clevis type,
high-tensile alloy steel

CE



EN 1677-3

GRADO 8

TECHNICAL DATA

- safety factor: 4
- heat treatment: hardening and tempering
- traceability code

LABORATORY TESTS

- chemical analysis, metallographic analysis
- tensile test
- fatigue test (min. 20,000 cycles)
- proof load test (100% of batch)

AVAILABLE CERTIFICATES

- Technical product specifications
- Test report UNI EN10204 type 2.2
- Inspection certificate UNI EN10204 type 3.1
- CE Declaration of Conformity

WLL	J		
kg	Ø mm	mm	
8058R	1120	6	28
8058R	2000	7-8	34
8058R	3150	10	44
8058R	5300	13	52

WLL	J		
kg	Ø mm	mm	
8058	8000	67	16

8060R - 8060

Clevis chain hooks,
high-tensile alloy steel

CE



EN 1677-2

GRADE 8

TECHNICAL DATA

- safety coefficient: 4
- heat treatment: hardening and tempering
- Traceability code on pin, safety latch, body

LABORATORY TESTS

- chemical analysis, metallographic analysis
- proof load test (WLL x 2.5)
- tensile test
- fatigue test (min. 20,000 cycles)

AVAILABLE CERTIFICATES

- Technical Product Specifications
- Test Report UNI EN10204 type 2.2
- Inspection Certificate UNI EN10204 type 3.1
- CE Declaration of Conformity

WLL	C		
kg	Ø mm	mm	
8060R	1120	6	19
8060R	2000	7-8	23
8060R	3150	10	27
8060R	5300	13	35

WLL	C		
kg	Ø mm	mm	
8060	8000	16	48

8061R - 8061F

Clevis grab hooks
with safety latch,
high-tensile alloy steel

CE

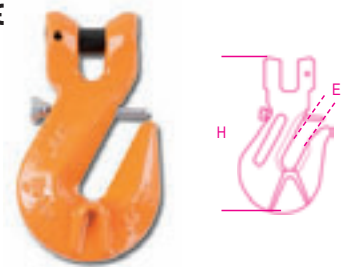

EN 1677-1

GRADO 8

TECHNICAL DATA

- safety factor: 4
- heat treatment: hardening and tempering
- traceability code

LABORATORY TESTS

- chemical analysis, metallographic analysis
- tensile test
- fatigue test (min. 20,000 cycles)
- proof load test (100% of batch)

AVAILABLE CERTIFICATES

- Technical product specifications
- Test report UNI EN10204 type 2.2
- Inspection certificate UNI EN10204 type 3.1
- CE Declaration of Conformity

WLL	E		
kg	Ø mm	mm	
8061R	1120	6	8
8061R	2000	7-8	11
8061R	3150	10	13

WLL	E		
kg	Ø mm	mm	
8061F	5300	13	16,5
8061F	8000	16	20,5

8062

slip hooks
alloy steel, painted

CE

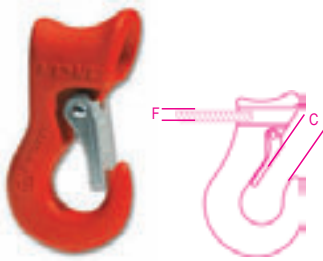

TECHNICAL DATA

- safety factor: 5
- heat treatment: hardening and tempering
- traceability code

LABORATORY TESTS

- chemical analysis, metallographic analysis
- proof load test (WLL x 2.5)
- tensile test

AVAILABLE CERTIFICATES

- Technical product specifications
- Test report UNI EN10204 type 2.2
- Inspection certificate UNI EN10204 type 3.1
- CE Declaration of Conformity

WLL kg	C mm	F mm		
1500	19	10-13	1	080620013
2000	21	16	1	080620016
3000	26	18	1	080620018
5000	34	22-25	1	080620025

Robur

8063

lifting swivel hooks
(in unloaded condition)
high-tensile alloy steel

CE

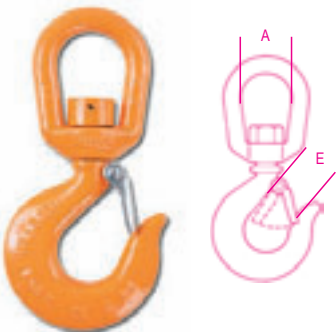

EN 1677-1
GRADE 8

TECHNICAL DATA

- safety factor: 4
- heat treatment: hardening and tempering
- traceability code

LABORATORY TESTS

- chemical analysis, metallographic analysis
- tensile test
- fatigue test (min. 20,000 cycles)
- proof load test (100% of batch)

AVAILABLE CERTIFICATES

- Technical Product Specifications
- Test report UNI EN10204 type 2.2
- Inspection certificate UNI EN10204 type 3.1
- CE Declaration of Conformity

WLL kg	A mm	E mm		
800	32	20,5	1	080630008
1120	38	20,5	1	080630011
2000	44,5	22	1	080630020
3150	44,5	27	1	080630031

8064S

swivel lifting hooks
(not under load)
carbon steel, painted

CE

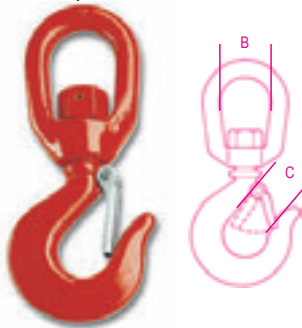

EN 1677-5
GRADE 4

TECHNICAL DATA

- safety factor: 5
- heat treatment: hardening and tempering
- traceability code

LABORATORY TESTS

- chemical analysis, metallographic analysis
- proof load test (WLL x 2.5)
- tensile test
- fatigue test (min. 20,000 cycles)

AVAILABLE CERTIFICATES

- Technical product specifications
- Test report UNI EN10204 type 2.2
- Inspection certificate UNI EN10204 type 3.1
- CE Declaration of Conformity

WLL kg	B mm	C mm		
800	31	20	1	080640107
1000	40	22	1	080640110
1600	47	23	1	080640115
2000	47	27	1	080640120
3200	64	35	1	080640130
5000	77	43	1	080640150
7500	90	53	1	080640175
10000	96	58	1	080640199

8065SC

swivel load lifting hooks
carbon steel, painted

CE

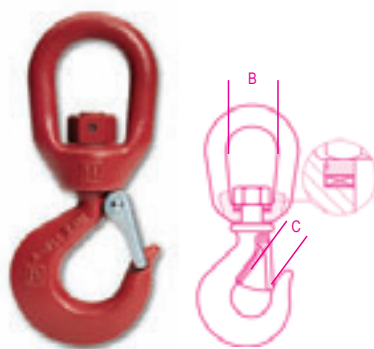

EN 1677-5
GRADE 4

TECHNICAL DATA

- safety factor: 5
- heat treatment: hardening and tempering
- traceability code

LABORATORY TESTS

- chemical analysis, metallographic analysis
- proof load test (WLL x 2.5)
- tensile test
- fatigue test (min. 20,000 cycles)

AVAILABLE CERTIFICATES

- Technical product specifications
- Test report UNI EN10204 type 2.2
- Inspection certificate UNI EN10204 type 3.1
- CE Declaration of Conformity

WLL kg	B mm	C mm		
800	38	20	1	080650107
1000	38	22	1	080650110
1600	47	23	1	080650115
2000	47	27	1	080650120
3200	54	35	1	080650130
5000	72	43	1	080650150
7500	82	53	1	080650175

8050D

safety locks and spare parts kit for eye hooks



Part Number	WLL kg	Eye Hook Part Number	Quantity
8050D1	8055/1250	8064S-8065SC/800	1 080500945
8050D2	8055S/1600	8064S-8065SC/1000	1 080500946
8050D3	8055/2500-3200	8064S-8065SC/1600-2000	1 080500947
8050D4	8055S/5400	8064S-8065SC/3200	1 080500948
8050D5	8055S/8000	8064S-8065SC/5000	1 080500949
8050D6	8055S/11500	8064S/7500	1 080500950
8050D7	8060/3150		1 080500951
8050D8	8060/5300		1 080500952
8050D7A	8060/2000		1 080500968
8050D10	8062/1500		1 080500954
8050D11	8062/2000		1 080500955
8050D12	8062/3000		1 080500956
8050D13	8062/5000		1 080500957
8050D22	8055S/16000	8064S/10000	1 080500966
8050D23	8055S/22000		1 080500967
8050D24	8051S/250		1 080500969
8050D25	8051S/500		1 080500970
8050D26	8061F/1120		1 080500971
8050D27	8061F/2000		1 080500972
8050D28	8061F/3150		1 080500973
8050D29	8061F/5300		1 080500974
8050D30	8061F/8000		1 080500975
8050D31	8060/1120		1 080500976
8050D32	8060/8000		1 080500977
8050D33	8052/800		1 080500978
8050D34	8052/1120		1 080500979
8050D35	8052/2000		1 080500980
8050D36	8052/3150		1 080500981
8050D37	8052/4000		1 080500982
8050D38	8060R/1120		1 080500983
8050D39	8060R/2000		1 080500984
8050D40	8060R/3150		1 080500985
8050D41	8060R/5300		1 080500986
8050D42	8063R/800		1 080500987
8050D43	8063R/1120		1 080500988
8050D44	8063R/2000		1 080500989
8050D45	8063R/3150		1 080500990
8050D46	8061R/1120		1 080500991
8050D47	8061R/2000		1 080500992
8050D48	8061R/3150		1 080500993

8085

lifting master links
alloy steel, painted

WLL means the use with 1 chain sling.

CE



EN 1677-4
GRADO 8

TECHNICAL DATA

- safety factor: 4
- heat treatment: hardening and tempering
- traceability code

LABORATORY TESTS

- chemical analysis, metallographic analysis
- proof load test (WLL x 2.5)
- tensile test

- fatigue test (min. 20,000 cycles)

AVAILABLE CERTIFICATES

- Technical product specifications
- Test report UNI EN10204 type 2.2
- Inspection certificate UNI EN10204 type 3.1
- CE Declaration of Conformity

WLL	kg	Ø mm	B mm	C mm		
* 1500	7	110	60		1	080850016
2000	8	110	60		1	080850020
3150	10	135	75		1	080850032
5300	13	160	90		1	080850054
8000	16	180	100		1	080850080
11200	19	200	110		1	080850190

* If you match it with a chain 6mm in Ø, WLL= 1120 kg

8086

lifting master link assemblies
alloy steel, painted

* WLL means the use with 3 or 4 chain slings
and β angle < 45°.

CE

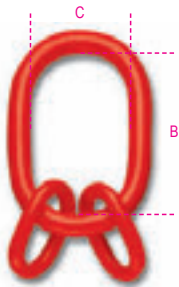

EN 1677-4
GRADO 8

TECHNICAL DATA

- safety factor: 4
- heat treatment: hardening and tempering
- traceability code

LABORATORY TESTS

- chemical analysis, metallographic analysis
- proof load test (WLL x 2.5)
- tensile test

- fatigue test (min. 20,000 cycles)

AVAILABLE CERTIFICATES

- Technical product specifications
- Test report UNI EN10204 type 2.2
- Inspection certificate UNI EN10204 type 3.1
- CE Declaration of Conformity

WLL	kg	Ø mm	B mm	C mm		
* 3150	7	135	75		1	080860021
4250	8	160	90		1	080860042
6700	10	180	100		1	080860067
11200	13	200	110		1	080860100
17000	16	260	140		1	080860117

*If you match it with a chain 6 mm in Ø, WLL=2360 Kg.

8090R - 8090

lifting connecting links
alloy steel, painted

CE

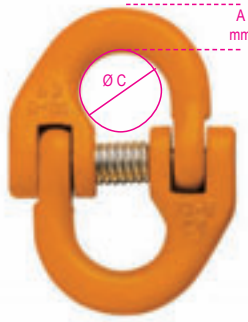

EN 1677-1
GRADO 8

TECHNICAL DATA

- safety factor: 4
- heat treatment: hardening and tempering
- traceability code

LABORATORY TESTS

- chemical analysis, metallographic analysis
- proof load test (WLL x 2.5)
- tensile test

- fatigue test (min. 20,000 cycles)

AVAILABLE CERTIFICATES

- Technical product specifications
- Test report UNI EN10204 type 2.2
- Inspection certificate UNI EN10204 type 3.1
- CE Declaration of Conformity

WLL	kg	Ø mm	A mm	max mm		
8090R	1120	6	13	7,5	1	080900111
8090R	1500	7	18	11	1	080900115
8090R	2000	8	18	9,0	1	080900120
8090R	3150	10	22	13,0	1	080900131

WLL	kg	Ø mm	A mm	max mm		
8090	5300	13	26	17	1	080900053
8090	8000	16	32	22	1	080900080

8090F

lifting connecting links for polyester slings,
alloy steel, painted

CE

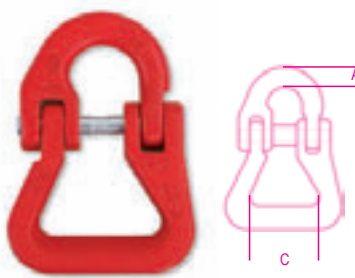

EN 1677-1
GRADO 8

TECHNICAL DATA

- safety factor: 4
- heat treatment: hardening and tempering
- traceability code

LABORATORY TESTS

- chemical analysis, metallographic analysis
- proof load test (WLL x 2.5)
- tensile test

- fatigue test (min. 20,000 cycles)

AVAILABLE CERTIFICATES

- Technical product specifications
- Test report UNI EN10204 type 2.2
- Inspection certificate UNI EN10204 type 3.1
- CE Declaration of Conformity

WLL	kg	Ø mm	A mm	C mm		
2000	7-8	10,5	40		1	080900220
3150	10	12	50		1	080900232
5300	13	17	60		1	080900253
8000	16	21	75		1	080900280

8100

lifting chains,
high-tensile alloy steel

CE

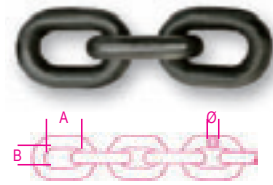

EN 818-2
GRADE 8

TECHNICAL DATA

- safety factor: 4
- heat treatment: hardening and tempering
- traceability code

LABORATORY TESTS

- chemical analysis
- metallographic analysis
- tensile test

AVAILABLE CERTIFICATES

- Technical Product Specifications
- Test Report UNI EN10204 type 2.2
- Manufacturer's Certificate EN818-2
- CE Declaration of Conformity

WLL	kg	Ø mm	A mm	B mm		
1120	6	18	7,8		1	081000011
1500	7	21	9,1		1	081000016
2000	8	24	10,4		1	081000020
3150	10	30	13		1	081000032
5300	13	39	16,9		1	081000053
8000	16	48	20,8		1	081000080

CHAIN SLINGS Grade 8

WLL Ton

UNI EN 818

Ø D mm	WLL 1	WLL 2	
		0° < β ≤ 45°	45° < β ≤ 60°
6	1,12	1,6	1,12
7	1,5	2,12	1,5
8	2	2,8	2
10	3,15	4,25	3,15
13	5,3	7,5	5,3
16	8	11,2	8

Ø D mm	WLL 3	WLL 3	
		0° < β ≤ 45°	45° < β ≤ 60°
6	2,36	1,7	
7	3,15	2,24	
8	4,25	3	
10	6,7	4,75	
13	11,2	8	
16	17	11,2	

8091

lifting chain slings, 1 leg
in plastic case

CE

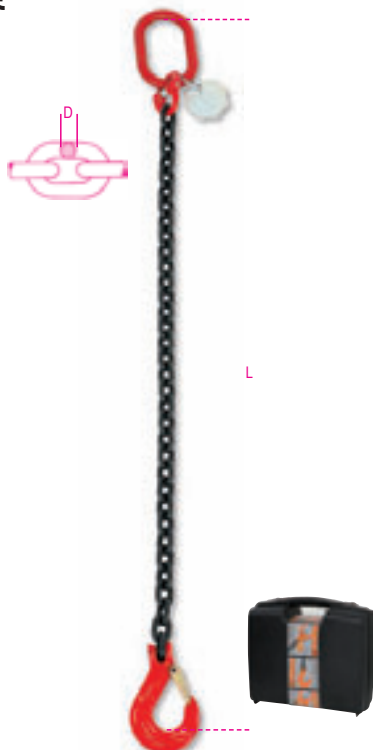

UNI EN 818-4

TECHNICAL DATA

- safety factor: 4
 - chain-sling identification tag
- ATTACHED CERTIFICATES
- Manufacturer's Certificate UNI EN818-4
 - CE Declaration of Conformity
- AVAILABLE CERTIFICATES
- Technical product specifications

D mm	L m	WLL ton		
6	1	1,12	1	080910001
6	2	1,12	1	080910002
6	3	1,12	1	080910003
6	4	1,12	1	080910004
7	1	1,5	1	080910021
7	2	1,5	1	080910022
7	3	1,5	1	080910023
7	4	1,5	1	080910024
8	1	2	1	080910041
8	2	2	1	080910042
8	3	2	1	080910043
8	4	2	1	080910044
10	1	3,15	1	080910051
10	2	3,15	1	080910052
10	3	3,15	1	080910053
10	4	3,15	1	080910054
13	1	5,3	1	080910131
13	2	5,3	1	080910132
13	3	5,3	1	080910133
13	4	5,3	1	080910134
16	1	8	1	080910161
16	2	8	1	080910162
16	3	8	1	080910163
16*	4	8	1	080910164

* packing suited to weight

Robur

8092

lifting chains sling, 2 legs
in plastic case

CE



UNI EN 818-4

TECHNICAL DATA

- safety factor: 4
 - chain-sling identification tag
- ATTACHED CERTIFICATES
- Manufacturer's Certificate UNI EN818-4
 - CE Declaration of Conformity
- AVAILABLE CERTIFICATES
- Technical product specifications

D mm	L m	WLL ton		
6	1	1,6	1	080920001
6	2	1,6	1	080920002
6	3	1,6	1	080920003
6	4	1,6	1	080920004
7	1	2,12	1	080920021
7	2	2,12	1	080920022
7	3	2,12	1	080920023
7	4	2,12	1	080920024
8	1	2,8	1	080920041
8	2	2,8	1	080920042
8	3	2,8	1	080920043
8	4	2,8	1	080920044
10	1	4,25	1	080920051
10	2	4,25	1	080920052
10	3	4,25	1	080920053
10	4	4,25	1	080920054
13	1	7,5	1	080920131
13	2	7,5	1	080920132
13*	3	7,5	1	080920133
13*	4	7,5	1	080920134
16	1	11,2	1	080920161
16*	2	11,2	1	080920162
16*	3	11,2	1	080920163
16*	4	11,2	1	080920164

* Wooden packing suited to weight

8094

lifting chain sling, 4 legs
in plastic case

CE



UNI EN 818-4

TECHNICAL DATA

- safety factor: 4
 - chain-sling identification tag
- ATTACHED CERTIFICATES
- Manufacturer's Certificate UNI EN818-4
 - CE Declaration of Conformity
- AVAILABLE CERTIFICATES
- Technical product specifications

D mm	L m	WLL ton		
6	1	2,36	1	080940001
6	2	2,36	1	080940002
6	3	2,36	1	080940003
6	4	2,36	1	080940004
7	1	3,15	1	080940021
7	2	3,15	1	080940022
7	3	3,15	1	080940023
7	4	3,15	1	080940024
8	1	4,25	1	080940041
8	2	4,25	1	080940042
8	3	4,25	1	080940043
8	4	4,25	1	080940044
10	1	6,7	1	080940051
10	2	6,7	1	080940052
10	3	6,7	1	080940053
10	4	6,7	1	080940054
13*	1	11,2	1	080940131
13*	2	11,2	1	080940132
13*	3	11,2	1	080940133
13*	4	11,2	1	080940134
16*	1	17	1	080940161
16*	2	17	1	080940162
16*	3	17	1	080940163
16*	4	17	1	080940164

* packing suited to weight

Robur

8096

lifting chain sling, 1 leg
with clevis grab hook,
in plastic case

CE



UNI EN 818-4

TECHNICAL DATA

- safety factor: 4
 - chain-sling identification tag
- ATTACHED CERTIFICATES
- Manufacturer's Certificate UNI EN818-4
 - CE Declaration of Conformity
- AVAILABLE CERTIFICATES
- Technical product specifications

D mm	L m	WLL ton		
6	1	1,12	1	080960001
6	2	1,12	1	080960002
6	3	1,12	1	080960003
6	4	1,12	1	080960004
7	1	1,5	1	080960021
7	2	1,5	1	080960022
7	3	1,5	1	080960023
7	4	1,5	1	080960024
8	1	2	1	080960041
8	2	2	1	080960042
8	3	2	1	080960043
8	4	2	1	080960044
10	1	3,15	1	080960051
10	2	3,15	1	080960052
10	3	3,15	1	080960053
10	4	3,15	1	080960054
13	1	5,3	1	080960131
13	2	5,3	1	080960132
13	3	5,3	1	080960133
13	4	5,3	1	080960134
16	1	8	1	080960161
16	2	8	1	080960162
16	3	8	1	080960163
16*	4	8	1	080960164

* packing suited to weight

8097

lifting chain sling, 2 legs
with clevis grab hooks,
in plastic case

CE



UNI EN 818-4

TECHNICAL DATA

- safety factor: 4
 - chain-sling identification tag
- ATTACHED CERTIFICATES
- Manufacturer's Certificate UNI EN818-4
 - CE Declaration of Conformity
- AVAILABLE CERTIFICATES

- Technical product specifications

D mm	L m	WLL ton		
6	1	1,6	1	080970001
6	2	1,6	1	080970002
6	3	1,6	1	080970003
6	4	1,6	1	080970004
7	1	2,12	1	080970021
7	2	2,12	1	080970022
7	3	2,12	1	080970023
7	4	2,12	1	080970024
8	1	2,8	1	080970041
8	2	2,8	1	080970042
8	3	2,8	1	080970043
8	4	2,8	1	080970044
10	1	4,25	1	080970051
10	2	4,25	1	080970052
10	3	4,25	1	080970053
10	4	4,25	1	080970054
13	1	7,5	1	080970131
13	2	7,5	1	080970132
13*	3	7,5	1	080970133
13*	4	7,5	1	080970134
16	1	11,2	1	080970161
16*	2	11,2	1	080970162
16*	3	11,2	1	080970163
16*	4	11,2	1	080970164

* packing suited to weight

8098

lifting chain sling, 4 legs
with clevis grab hooks,
in plastic case

CE



UNI EN 818-4

TECHNICAL DATA

- safety factor: 4
 - chain-sling identification tag
- ATTACHED CERTIFICATES
- Manufacturer's Certificate UNI EN818-4
 - CE Declaration of Conformity
- AVAILABLE CERTIFICATES
- Technical product specifications

D mm	L m	WLL ton		
6	1	2,36	1	080980001
6	2	2,36	1	080980002
6	3	2,36	1	080980003
6	4	2,36	1	080980004
7	1	3,15	1	080980021
7	2	3,15	1	080980022
7	3	3,15	1	080980023
7	4	3,15	1	080980024
8	1	4,25	1	080980041
8	2	4,25	1	080980042
8	3	4,25	1	080980043
8	4	4,25	1	080980044
10	1	6,7	1	080980051
10	2	6,7	1	080980052
10	3	6,7	1	080980053
10	4	6,7	1	080980054
13*	1	11,2	1	080980131
13*	2	11,2	1	080980132
13*	3	11,2	1	080980133
13*	4	11,2	1	080980134
16*	1	17	1	080980161
16*	2	17	1	080980162
16*	3	17	1	080980163
16*	4	17	1	080980164

* packing suited to weight

POLYESTER SLINGS

TECHNICAL DATA

- safety factor: 7
- traceability code

LABORATORY TESTS

- tensile test

AVAILABLE CERTIFICATES

- Technical product specifications
- Test report UNI EN10204 type 2.2
- Manufacturer's Certificate UNI EN1492
- CE Declaration of Conformity

				$\beta = 0^\circ - 45^\circ$	$\beta = 45^\circ - 60^\circ$
30	1t	0,8t	2t	1,4t	1t
60	2t	1,6t	4t	2,8t	2t
90	3t	2,4t	6t	4,2t	3t
120	4t	3,2t	8t	5,6t	4t
150	5t	4,0t	10t	7,0t	5t
180	6t	4,8t	12t	8,4t	6t
240	8t	6,4t	16t	11,2t	8t
300	10t	8,0t	20t	14,0t	10t

8150

lifting web slings, purple 1t
two layers with reinforced eyes
high-tenacity polyester (PES) belt

CE



UNI EN 1492-1

L m	H mm	WLL ton	1	2
0,5	30	1	1	081500005
1	30	1	1	081500010
1,5	30	1	1	081500015
2	30	1	1	081500020
2,5	30	1	1	081500025
3	30	1	1	081500030
4	30	1	1	081500040
5	30	1	1	081500050
6	30	1	1	081500060
8	30	1	1	081500080

Robur

8153

lifting web slings, green 2t
two layers with reinforced eyes
high-tenacity polyester (PES) belt

CE



UNI EN 1492-1

L m	H mm	WLL ton	1	2
1	60	2	1	081530010
1,5	60	2	1	081530015
2	60	2	1	081530020
2,5	60	2	1	081530025
3	60	2	1	081530030
4	60	2	1	081530040
5	60	2	1	081530050
6	60	2	1	081530060
8	60	2	1	081530080
10	60	2	1	081530100

8156

lifting web slings, yellow 3t
two layers with reinforced eyes
high-tenacity polyester (PES) belt

CE

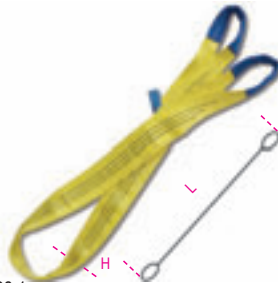

UNI EN 1492-1

L m	H mm	WLL ton	1	2
1	90	3	1	081560010
1,5	90	3	1	081560015
2	90	3	1	081560020
2,5	90	3	1	081560025
3	90	3	1	081560030
4	90	3	1	081560040
5	90	3	1	081560050
6	90	3	1	081560060
8	90	3	1	081560080
10	90	3	1	081560100
12	90	3	1	081560120

Robur

8157

lifting web slings, grey 4t
two layers with reinforced eyes
high-tenacity polyester (PES) belt

CE



UNI EN 1492-1

L m	H mm	WLL ton	1	2
2	120	4	1	081570020
3	120	4	1	081570030
4	120	4	1	081570040
5	120	4	1	081570050
6	120	4	1	081570060
8	120	4	1	081570080
10	120	4	1	081570100
12	120	4	1	081570120

8158

lifting web slings, red 5t
two layers with reinforced eyes
high-tenacity polyester (PES) belt

CE



UNI EN 1492-1

L m	H mm	WLL ton	1	2
2	150	5	1	081580020
3	150	5	1	081580030
4	150	5	1	081580040
5	150	5	1	081580050
6	150	5	1	081580060
8	150	5	1	081580080
10	150	5	1	081580100
12	150	5	1	081580120

Robur

8159

lifting web slings, brown 6t
two layers with reinforced eyes
high-tenacity polyester (PES)

CE



UNI EN 1492-1

L m	H mm	WLL ton		
3	180	6	1	081590030
4	180	6	1	081590040
5	180	6	1	081590050
6	180	6	1	081590060
8	180	6	1	081590080
10	180	6	1	081590100



8160

lifting web slings, blue 8t
two layers with reinforced eyes
high-tenacity polyester (PES)

CE



UNI EN 1492-1

L m	H mm	WLL ton		
3	240	8	1	081600030
5	240	8	1	081600050
6	240	8	1	081600060
8	240	8	1	081600080
10	240	8	1	081600100



8161

lifting web slings, orange 10t
two layers with reinforced eyes
high-tenacity polyester (PES)

CE

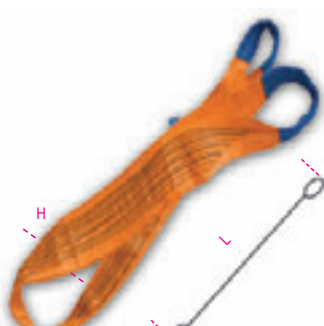

UNI EN 1492-1

L m	H mm	WLL ton		
4	300	10	1	081610040
5	300	10	1	081610050
6	300	10	1	081610060
8	300	10	1	081610080
10	300	10	1	081610100
12	300	10	1	081610120

8170

lifting round slings, purple 1t
high-tenacity polyester (PES) belt

CE



UNI EN 1492-2

L m	WLL ton	H mm		
0,5	1	45	1	081700010
1	1	45	1	081700020
1,5	1	45	1	081700030
2	1	45	1	081700040
3	1	45	1	081700060
4	1	45	1	081700080



8173

lifting round slings, green 2t
high-tenacity polyester (PES) belt

CE

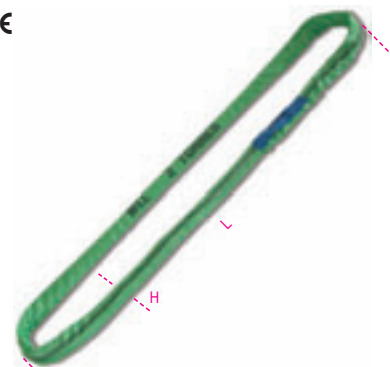

UNI EN 1492-2

L m	H mm	WLL ton		
0,5	50	2	1	081730010
1	50	2	1	081730020
1,5	50	2	1	081730030
2	50	2	1	081730040
2,5	50	2	1	081730050
3	50	2	1	081730060
4	50	2	1	081730080
5	50	2	1	081730100
6	50	2	1	081730120

8176

lifting round slings, yellow 3t
high-tenacity polyester (PES) belt

CE

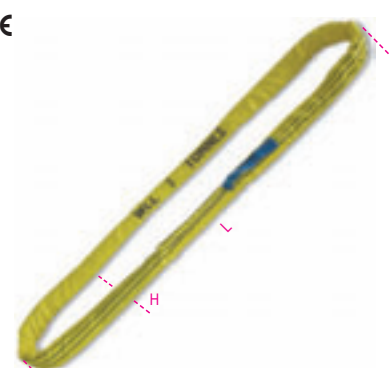

UNI EN 1492-2

L m	H mm	WLL ton		
1	60	3	1	081760020
1,5	60	3	1	081760030
2	60	3	1	081760040
2,5	60	3	1	081760050
3	60	3	1	081760060
4	60	3	1	081760080
5	60	3	1	081760100
6	60	3	1	081760120

8177

lifting round slings, grey 4t
high-tenacity polyester (PES) belt

CE



UNI EN 1492-2

L m	H mm	WLL ton	
1	65	4	1 081770020
1,5	65	4	1 081770030
2	65	4	1 081770040
2,5	65	4	1 081770050
3	65	4	1 081770060
4	65	4	1 081770080
5	65	4	1 081770100
6	65	4	1 081770120
8	65	4	1 081770160

8178

lifting round slings, red 5t
high-tenacity polyester (PES) belt

CE

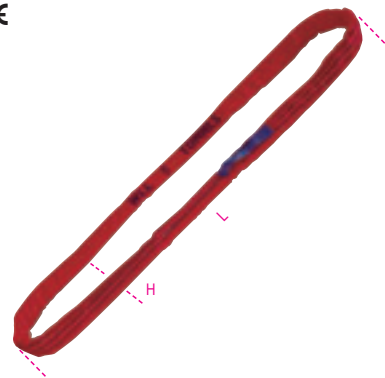

UNI EN 1492-2

L m	H mm	WLL ton	
1	70	5	1 081780020
1,5	70	5	1 081780030
2	70	5	1 081780040
2,5	70	5	1 081780050
3	70	5	1 081780060
4	70	5	1 081780080
5	70	5	1 081780100
6	70	5	1 081780120
8	70	5	1 081780160

Robur

8179M

lifting round slings, brown 6t
high-tenacity polyester (PES) belt

CE

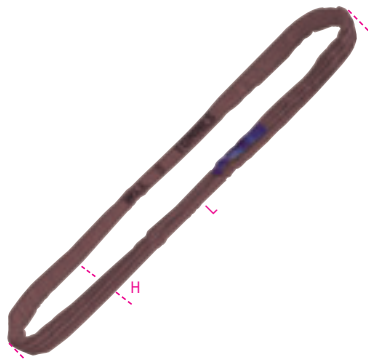

UNI EN 1492-2

L m	H mm	WLL ton	
3	80	6	1 081790060
4	80	6	1 081790080
6	80	6	1 081790120
8	80	6	1 081790160

8179B

lifting round slings, blue, 8 t,
high-tenacity polyester (PES) belt

CE

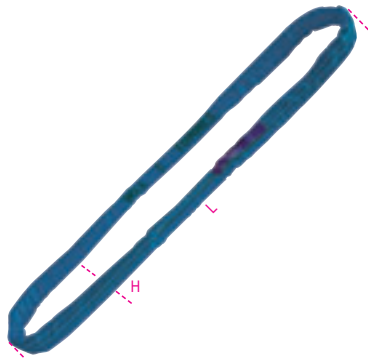

UNI EN 1492-2

L m	H mm	WLL ton	
1	85	8	1 081790220
3	85	8	1 081790260
4	85	8	1 081790280
6	85	8	1 081790320
8	85	8	1 081790360

8179A

lifting round slings, orange, 10 t,
high-tenacity polyester (PES) belt

CE

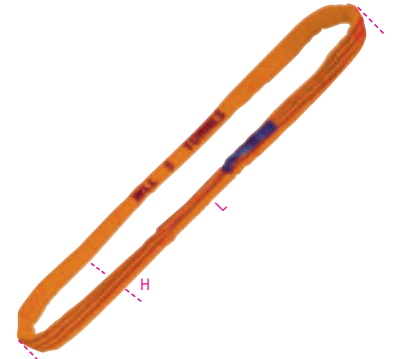

UNI EN 1492-2

L m	H mm	WLL ton	
3	95	10	1 081790506
4	95	10	1 081790508
6	95	10	1 081790512
8	95	10	1 081790516
10	95	10	1 081790520

8166

anti-abrasion sheaths for slings,
high-tenacity polyester (PES),
with elastomer underlayer



H mm	ø mm	L m	
70	45	3	1 081660073
80	52	3	1 081660083
110	70	3	1 081660103
155	100	3	1 081660153
170	110	3	1 081660170
235	150	4	1 081660235

H mm			
70	8150	8170-8173	081660073
80	8153	8176	081660083
110	8153-8156	8177-8178	081660103
155	8157	8178-8179A 8179B-8179M	081660153
170	8158	-	081660170
235	8159	-	081660235

Robur INOX STAINLESS STEEL

485

Robur

RATCHET TIE DOWNS

TECHNICAL DATA

- safety factor: 2
- traceability code
- LABORATORY TESTS
- ratchet pretensioning test
- metal parts deformation test
- complete system tensile test
- AVAILABLE CERTIFICATES
- Technical product specifications
- Test report UNI EN10204 type 2.2

8180

ratchet tie down with single hook, LC 750kg
high-tenacity polyester (PES) belt

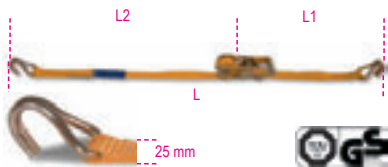

EN 12195-2

L m	L2 mm	L1 mm		
4	3750	250	1	081800004
6	5750	250	1	081800006
8	7750	250	1	081800008

LC = 750 kg

8181

ratchet tie down with single hook, LC 1000kg
high-tenacity polyester (PES) belt

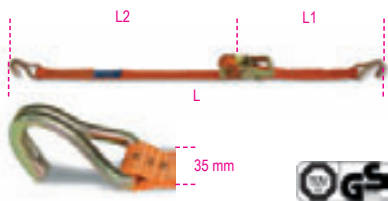

EN 12195-2

L m	L2 mm	L1 mm		
4	3600	400	1	081810004
6	5600	400	1	081810006
8	7600	400	1	081810008

LC = 1000 kg

8181S

ratchet tie down with double hook, LC 1000kg,
high-tenacity polyester (PES) belt

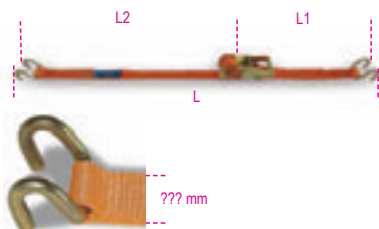

EN 12195-2

L m	L2 mm	L1 mm		
6	5600	400	1	081810206

LC = 1000 kg

8182

ratchet tie down with single hook, LC 2000kg
high-tenacity polyester (PES) belt

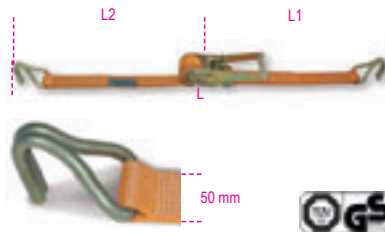

EN 12195-2

L m	L2 mm	L1 mm		
6,5	6100	400	1	081820065
8,5	8100	400	1	081820085
10,5	10100	400	1	081820105
14,5	14100	400	1	081820145

LC = 2000 kg

	L2 mm	L1 mm		
8182LP long part	8100		1	081820902
8182SP short part		400	1	081820905

8182S

ratchet tie down with double hook, LC 2000kg
high-tenacity polyester (PES) belt

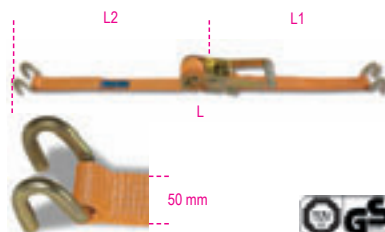

EN 12195-2

L m	L2 mm	L1 mm		
8,5	8100	400	1	081820285
10,5	10100	400	1	081820305

LC = 2000 kg

	L2 mm	L1 mm		
8182SLP long part	8100		1	081820912
8182SSP short part		400	1	081820915



Robur

8182A

ratchet tie downs with 2 eyes,
high-tenacity polyester (PES) belt,
LC 2000 kg



EN 12195-2

L m	L2 mm	L1 mm	H mm		
8,5	8100	400		1	081820585

LC = 2000 kg

8182E

ratchet tie downs for van and truck interiors,
LC 1000 kg,
high-tenacity polyester (PES) belt

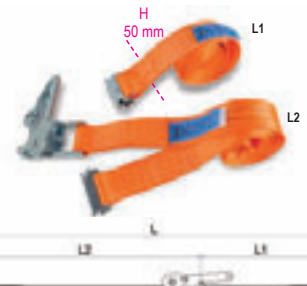

EN 12195-2

L m	L2 mm	L1 mm	H mm		
4	3500	500	50	1	081820440

LC = 1000 kg

	L2 mm	L1 mm		
8182EL	2500		1	081820942
8182EC		1500	1	081820945

8185

ring ratchet tie down, LC 1500kg
high-tenacity polyester (PES) belt



EN 12195-2

L m		
5	1	081850005
8	1	081850008

8186

ring ratchet tie down, LC 2000kg
high-tenacity polyester (PES) belt

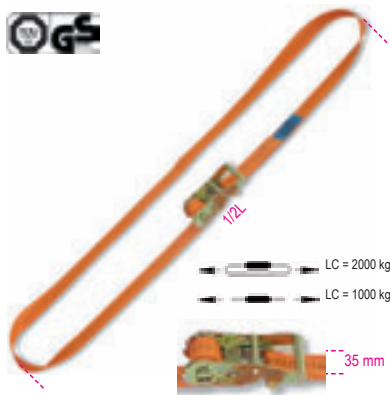

EN 12195-2

L m		
5	1	081860005
8	1	081860008

8187

ring ratchet tie down, LC 4000kg
high-tenacity polyester (PES) belt



EN 12195-2

L m		
5	1	081870005
8	1	081870008

8188F

cam buckle straps, LC 200 kg,
high-grade polypropylene (PP) belt

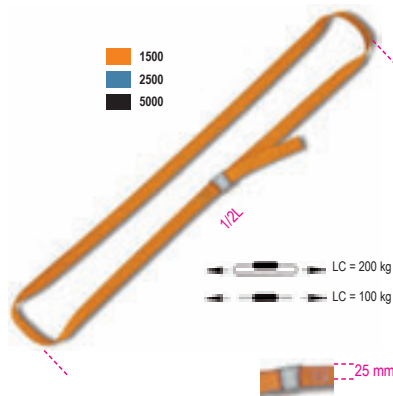

EN 12195-2

L m		
1,5	10	081880215
2,5	10	081880225
5,0	6	081880250

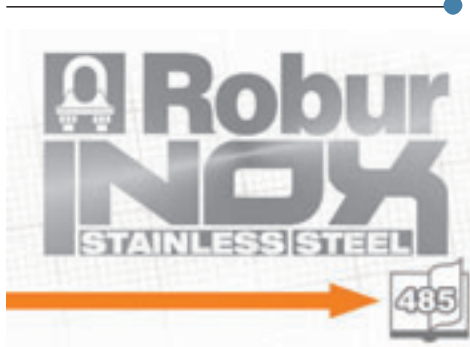

8188VF/35

cam buckle straps, LC 500 kg,
high-tenacity polypropylene (PP) belt

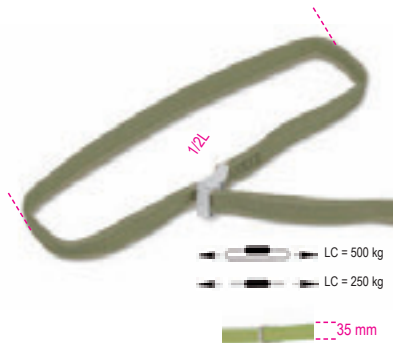

EN 12195-2

L m		
4	3	081881290



8188C

ring ratchet tie downs, LC 750 kg,
high-tenacity polyester (PES) belt



EN 12195-2

L m		
5	3	081880350



8188CG/25

ratchet tie downs with S-hooks and Eyes,
LC 375 kg
high-tenacity polyester (PES) strap

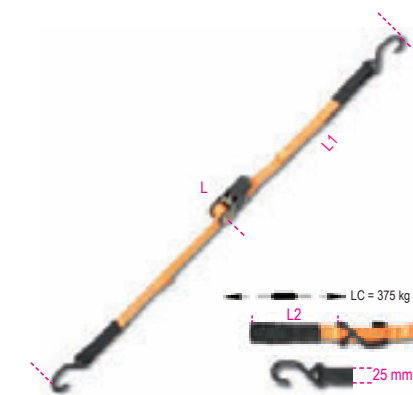

EN 12195-2

L m	L1 mm	L2 mm	
3	480	170	1 081880430
5	480	170	1 081880450

8188VFG2

cam buckle strap with S-hooks and Eyes,
LC 250 kg
high-grade polypropylene (PP) belt



EN 12195-2

L	L1	L2		
m	mm	mm		
3	450	110	1	081881530

8188FG3

cam buckle straps with 3 S-hooks and Eyes,
LC 250 kg
high-grade polypropylene (PP) belt

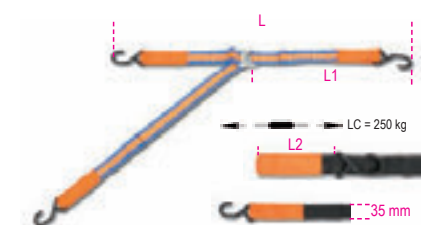

L max	L min	L1	L2		
m	m	mm	mm		
3,5	0,85	450	110	1	081880630

8189

polyester belt (PES)
for ratchet tie downs



H	L	LC		
mm	m	kg		
25	100	750	1	081890902
35	100	1000	1	081890903
50	100	2000	1	081890905

8189PA

2 angular guards
for polyester belts



L1xL2	H1	H2		
mm	mm	mm		
100x60	60	12	1	081890060
135x90	60	18	1	081890090



Breaking force (BF)
on technical specifications
WWW.ROBURITALY.COM

8201T

pipe bodies
AISI 316



LABORATORY TESTS

- chemical analysis
- tensile test

AVAILABLE CERTIFICATES

- Technical Product Specifications
- Test Report UNI EN10204 type 2.2

Ø	Ø	WFL	L		
mm	mm	kg	mm		
M6	1/4	160	95	5	082010406
M8	5/16	300	105	5	082010408
M10	3/8	470	125	3	082010410
M12	1/2	690	150	3	082010412
M14	9/16	940	165	1	082010414
M16	5/8	1290	190	1	082010416
M20	3/4	2130	210	1	082010420

8205

eye and eye turnbuckle
AISI 316

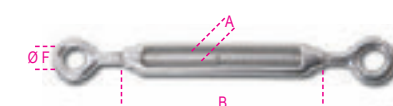

LABORATORY TESTS

- chemical analysis
- tensile test

AVAILABLE CERTIFICATES

- Technical product specifications
- Test report UNI EN10204 type 2.2

A	B	Ø F	WFL		
mm	mm	mm	kg		
M4	62	8	75	10	082050204
M5	72	11	115	10	082050205
M6	92	12	160	5	082050206
M8	122	14	300	5	082050208
M10	150	16	470	1	082050210
M12	201	18	690	1	082050212
M14	225	22	940	1	082050214
M16	244	26	1290	1	082050216
M20	295	29	2130	1	082050220
M24	350	33	3000	1	082050224

8206

hook and eye turnbuckle
AISI 316

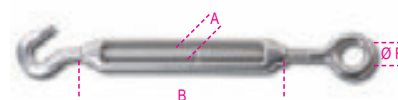

LABORATORY TESTS

- chemical analysis
- tensile test

AVAILABLE CERTIFICATES

- Technical product specifications
- Test report UNI EN10204 type 2.2

A	B	Ø F	WFL		
mm	mm	mm	kg		
M5	72	11	25	10	082060205
M6	92	12	45	5	082060206
M8	122	14	95	5	082060208
M10	150	16	140	1	082060210
M12	201	18	300	1	082060212
M14	225	22	420	1	082060214
M16	244	26	570	1	082060216
M20	295	29	875	1	082060220

8207

hook and hook turnbuckle
AISI 316

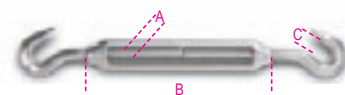

LABORATORY TESTS

- chemical analysis
- tensile test

AVAILABLE CERTIFICATES

- Technical product specifications
- Test report UNI EN10204 type 2.2

A	B	C	WFL		
mm	mm	mm	kg		
M5	72	9	25	10	082070205
M6	92	9	45	5	082070206
M8	122	10	95	5	082070208
M10	150	12	140	1	082070210
M12	201	14	300	1	082070212
M14	225	15	420	1	082070214
M16	244	16	570	1	082070216
M20	295	19	875	1	082070220

8209

jaw and jaw turnbuckle
AISI 316

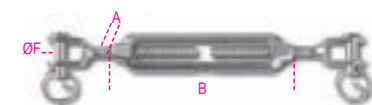

LABORATORY TESTS

- chemical analysis
- tensile test

AVAILABLE CERTIFICATES

- Technical product specifications
- Test report UNI EN10204 type 2.2

A	B	Ø F	WFL		
mm	mm	mm	kg		
M5	72	5	115	5	082090205
M6	92	6	160	5	082090206
M8	122	8	300	5	082090208
M10	150	10	470	1	082090210
M12	201	12	690	1	082090212
M14	225	14	940	1	082090214
M16	244	16	1290	1	082090216
M20	295	20	2130	1	082090220
M24	350	24	3060	1	082090224

8210

jaw and jaw pipe turnbuckle
AISI 316

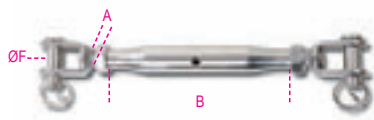

LABORATORY TESTS

- chemical analysis
- tensile test

AVAILABLE CERTIFICATES

- Technical product specifications
- Test report UNI EN10204 type 2.2

A	B	øF	WFL		
mm	mm	mm	kg		
M5	81	5	115	3	082100205
M6	92	6	160	3	082100206
M8	112	8	300	1	082100208
M10	121	10	470	1	082100210
M12	150	12	690	1	082100212
M14	169	14	940	1	082100214
M16	190	16	1290	1	082100216
M20	220	20	2130	1	082100220

8216

wire rope clips
AISI 316

CE

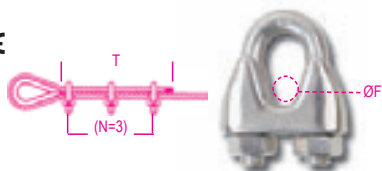

LABORATORY TESTS

- chemical analysis
- torque test

AVAILABLE CERTIFICATES

- Technical product specifications
- Test report UNI EN10204 type 2.2
- CE Certificate of Conformity

øF	"	T	N		
mm		mm			
2	5/64	80	3	15	082160202
3	1/8	80	3	15	082160203
4	5/32	80	3	10	082160204
5	3/16	110	3	10	082160205
6	1/4	120	5	10	082160206
8	5/16	210	5	5	082160208
10	3/8	240	5	5	082160210
12-13	1/2	300	5	5	082160213
16	5/8	335	5	5	082160216
20	3/4	540	5	5	082160220
22	7/8	595	7	3	082160222

8220

thimbles
AISI 316

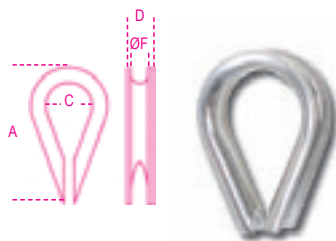

LABORATORY TESTS

- chemical analysis

AVAILABLE CERTIFICATES

- Technical product specifications
- Test report UNI EN10204 type 2.2

øF	D	A	C		
mm	mm	mm	mm		
2	4,5	21	7,5	15	082200202
3	6	24	10	15	082200203
4	6,6	28	11	10	082200204
5	8,5	30	13	10	082200205
6	10	37	15	10	082200206
8	12,5	51	23	5	082200208
10	14,6	56	27	5	082200210
12	18	68	32	5	082200212
14	19	69	34	5	082200214
16	22	83	37	5	082200216
18	23	81	38	1	082200218
20	27,8	105	45	1	082200220
22	29,6	112	45	1	082200222

8225

dee shackles
AISI 316

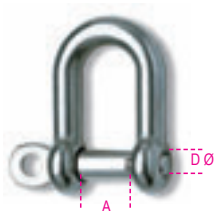

LABORATORY TESTS

- chemical analysis
- tensile test

AVAILABLE CERTIFICATES

- Technical product specifications
- Test report UNI EN10204 type 2.2

øD	"	A	WFL		
mm		mm	kg		
4	5/32	8	50	10	082250204
5	3/16	11	70	10	082250205
6	1/4	13	100	5	082250206
8	5/16	17	250	5	082250208
10	3/8	21	400	3	082250210
12	1/2	25	600	3	082250212
16	5/8	32	1000	1	082250216
19	3/4	38	1600	1	082250219
22	7/8	43	2000	1	082250222
25	1	46	2800	1	082250225

8227

long dee shackles
AISI 316



LABORATORY TESTS

- chemical analysis
- tensile test

AVAILABLE CERTIFICATES

- Technical product specifications
- Test report UNI EN10204 type 2.2

øD	"	A	WFL		
mm		mm	kg		
4	5/32	8	50	10	082270204
5	3/16	10	70	10	082270205
6	1/4	13,5	100	5	082270206
8	5/16	17	250	5	082270208
10	3/8	21	400	1	082270210
12	1/2	25	600	1	082270212

8228

bow shackles
AISI 316

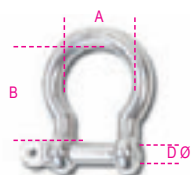

LABORATORY TESTS

- chemical analysis
- tensile test

AVAILABLE CERTIFICATES

- Technical product specifications
- Test report UNI EN10204 type 2.2

øD	A	B	WFL		
mm	mm	mm	kg		
4	13	20	60	10	082280204
5	17	23	80	10	082280205
6	20	27	100	10	082280206
8	28	36	200	5	082280208
10	36	44	300	5	082280210
12	41	53	500	5	082280212
16	54	74	800	1	082280216
19	66	86	1100	1	082280219

8240

eye bolts,
stainless steel AISI 316



LABORATORY TESTS

- chemical analysis
- tensile test

AVAILABLE CERTIFICATES

- Technical product specifications
- Test report UNI EN10204 type 2.2

A	B	øC	WFL		
mm	mm	mm	kg		
M6	41	15	75	10	082400206
M8	50	20	140	10	082400208
M10	62	25	230	5	082400210
M12	74	30	340	5	082400212

8242

eye nuts
stainless steel AISI 316



A	B	øC	WFL		
mm	mm	mm	kg		
M6	27	15	75	10	082420206
M8	36	20	140	10	082420208
M10	45	25	230	5	082420210
M12	55	30	340	5	082420212

8240F

lifting eye bolts, FORGED
stainless steel A4

CE



TECHNICAL DATA

- safety factor: 6
- traceability code

LABORATORY TESTS

- chemical analysis
- metallographic analysis
- tensile test

AVAILABLE CERTIFICATES

- Technical product specifications
- Test report UNI EN10204 type 2.2
- Inspection certificate UNI EN10204 type 3.1
- CE Declaration of Conformity

ø	WLL		
mm	mm	kg	
* M8	1,25	200	4 082400408
* M10	1,5	400	4 082400410
* M12	1,75	600	4 082400412
* M14	2	1000	2 082400414
* M16	2	1200	2 082400416
* M20	2,5	2000	2 082400420
* M24	3	2700	2 082400424
* M30	3,5	4000	1 082400430

(* WLL increased compared to DIN standard according to Technical Specifications R/FT/8240F (guaranteed for stainless steel / stainless steel fits)

8242F

lifting eye nuts, FORGED
stainless steel A4

CE



TECHNICAL DATA

- safety factor: 6
- traceability code

LABORATORY TESTS

- chemical analysis
- metallographic analysis
- tensile test

AVAILABLE CERTIFICATES

- Technical product specifications
- Test report UNI EN10204 type 2.2
- Inspection certificate UNI EN10204 type 3.1
- CE Declaration of conformity

ø	WLL		
mm	mm	kg	
* M8	1,25	200	4 082420408
* M10	1,5	400	4 082420410
* M12	1,75	600	4 082420412
* M14	2	1000	2 082420414
* M16	2	1200	2 082420416
* M20	2,5	2000	2 082420420
* M24	3	2700	2 082420424
* M30	3,5	4000	1 082420430

(* WLL ø M10÷M24

- increased according to Technical File R/FT/8242F
- guaranteed with stainless steel coupling

8248

eye tie rods,
stainless steel 316L,
right thread



UNI 6058

AVAILABLE CERTIFICATES

- Technical Product Specifications
- Test Report UNI EN10204 type 2.2

ØxL	F		
mm	mm		
10x80	8	1	082480010
10x130	8	1	082480012
12x95	10	1	082480016
12x125	10	1	082480018

8249

fastening eyebolts, right thread
AISI 316



LABORATORY TESTS

- chemical analysis
- tensile test

AVAILABLE CERTIFICATES

- Technical product specifications
- Test report UNI EN10204 type 2.2

A	øB	D	WFL		
mm	mm	mm	kg		
M5	11	50	100	10	082490205
M6	13	55	160	10	082490206
M8	17	60	300	5	082490208
M10	21	80	470	5	082490210
M12	25	120	690	1	082490212

8249G

fastening hooks
AISI 316



LABORATORY TESTS

- chemical analysis
- tensile test

AVAILABLE CERTIFICATES

- Technical Product Specifications
- Test Report UNI EN10204 type 2.2

A	E	øF	WFL		
mm	mm	mm	kg		
M5	39	9	25	5	082490305
M6	43	10,5	45	5	082490306
M8	57	14,5	95	3	082490308

8250

spring snap-casting eye end
AISI 316



LABORATORY TESTS

- chemical analysis
- tensile test

AVAILABLE CERTIFICATES

- Technical product specifications
- Test report UNI EN10204 type 2.2

L	A	øB	WFL		
mm	mm	mm	kg		
50	25	8	40	5	082500205
70	31	12,5	90	5	082500207
100	47	20	190	1	082500210

 **Robur**

8264

swivel eye bolt snap
AISI 316



LABORATORY TESTS

- chemical analysis
- tensile test

AVAILABLE CERTIFICATES

- Technical product specifications
- Test report UNI EN10204 type 2.2

B mm	L mm	C mm	WFL kg		
12	88	12	60	5	082640212
16	90	12	60	5	082640216
19	93	12	60	1	082640219

8267

swivel eye snap
AISI 316



LABORATORY TESTS

- chemical analysis
- tensile test

AVAILABLE CERTIFICATES

- Technical product specifications
- Test report UNI EN10204 type 2.2

A mm	L mm	B mm	WFL kg		
10	87	21	30	5	082670210
12	118	22	70	1	082670213

8272

eye and eye swivels
AISI 316

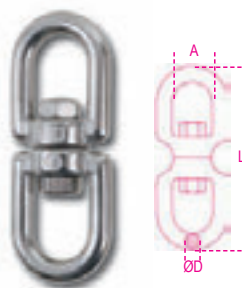

LABORATORY TESTS

- chemical analysis
- tensile test

AVAILABLE CERTIFICATES

- Technical product specifications
- Test report UNI EN10204 type 2.2

ø D mm	A mm	L mm	WFL kg		
4	11	50	90	5	082720204
5	13	60	115	5	082720205
6	15	66	140	5	082720206
8	19	90	250	3	082720208
10	23	112	300	1	082720210
13	33	148	650	1	082720213
16	38	184	1000	1	082720216
19	40	223	1600	1	082720219

8273

quick-release hooks
with swivel eyes
AISI 316 stainless steel



LABORATORY TESTS

- chemical analysis
- tensile test

AVAILABLE CERTIFICATES

- Technical product specifications
- Test report UNI EN10204 type 2.2

ø C x L mm	B mm	WFL kg	BF kg		
12x70	12	230	1100	1	082730012
16x85	14,50	440	2000	1	082730016
22x120	20	700	3500	1	082730022

8274

carabine hooks
AISI 316



LABORATORY TESTS

- chemical analysis
- tensile test

AVAILABLE CERTIFICATES

- Technical product specifications
- Test report UNI EN10204 type 2.2

ø A x L mm	ø C mm	D mm	WFL kg		
4,5x40	6,5	6	20	10	082740204
5x50	8	7	30	10	082740205
6x60	8,5	7,5	40	5	082740206
7x70	10	9	60	5	082740207
8x80	12	10	75	5	082740208
9x90	12,5	10,5	100	5	082740209
10x100	15	13	120	1	082740210
11x120	19	18	140	1	082740211
12x140	22	21	140	1	082740212
13x160	22	26	200	1	082740213

8274A

ring carabine hooks
AISI 316

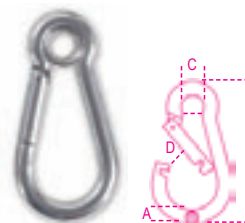

LABORATORY TESTS

- chemical analysis
- tensile test

AVAILABLE CERTIFICATES

- Technical Product Specifications
- Test Report UNI EN10204 type 2.2

ø A x L mm	ø C mm	D mm	WFL kg		
5x50	6,5	7	30	10	082740405
6x60	7,5	7,5	40	5	082740406
8x80	9,5	10	75	5	082740408

 **Robur**

 **Robur**

8274G

carabine hooks with screw nut
AISI 316

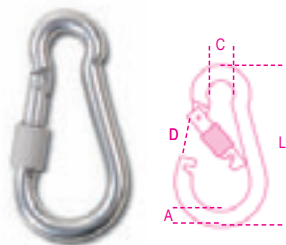

LABORATORY TESTS

- chemical analysis
- tensile test

AVAILABLE CERTIFICATES

- Technical product specifications
- Test report UNI EN10204 type 2.2

∅ A x L	∅ C	D	WFL		
mm	mm	mm	kg		
6x60	8,5	6,5	40	5	082740306
8x80	12	8,5	75	5	082740308
10x100	15	12	120	3	082740310

8276

asymmetric carabine hooks
AISI 316

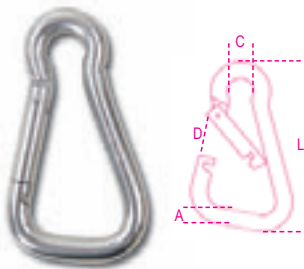

LABORATORY TESTS

- chemical analysis
- tensile test

AVAILABLE CERTIFICATES

- Technical product specifications
- Test report UNI EN10204 type 2.2

∅ A x L	∅ C	D	WFL		
mm	mm	mm	kg		
6x60	8,5	10	40	5	082760206
8x80	12	14	75	5	082760208
10x100	15	18	120	3	082760210

8276G

asymmetric carabine hooks with screw nut
AISI 316

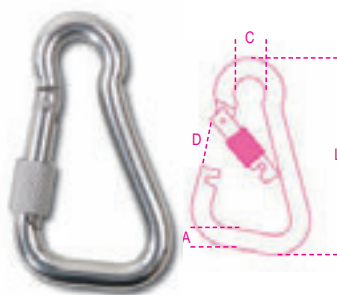

LABORATORY TESTS

- chemical analysis
- tensile test

AVAILABLE CERTIFICATES

- Technical product specifications
- Test report UNI EN10204 type 2.2

∅ A x L	∅ C	D	WFL		
mm	mm	mm	kg		
6x60	8,5	9	40	3	082760306
8x80	12	12,5	75	3	082760308
10x100	15	16	120	3	082760310

8278

trapezoidal carabine hooks
AISI 316

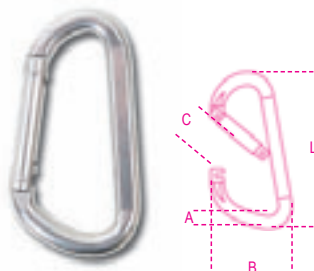

LABORATORY TESTS

- chemical analysis
- tensile test

AVAILABLE CERTIFICATES

- Technical product specifications
- Test report UNI EN10204 type 2.2

∅ A x L	B	C	WFL		
mm	mm	mm	kg		
8x80	45	14	75	3	082780208
10x100	55	16	120	3	082780210

8280

quick links
AISI 316

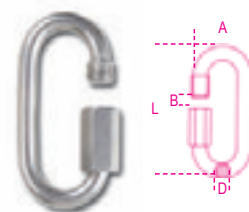

LABORATORY TESTS

- chemical analysis
- tensile test

AVAILABLE CERTIFICATES

- Technical product specifications
- Test report UNI EN10204 type 2.2

∅ D x L	A	B	WFL		
mm	mm	mm	kg		
3,5x35	17	5	20	10	082800203
4x40	19	6	30	10	082800204
5x50	23	7	50	5	082800205
6x60	26	8	60	5	082800206
7x70	30	9	100	5	082800207
8x80	33	10	140	1	082800208
10x90	40	12	220	1	082800210
12x100	47	14	300	1	082800212

8282

S-hooks
AISI 316

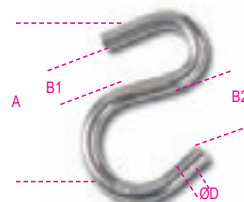

LABORATORY TESTS

- chemical analysis
- tensile test

AVAILABLE CERTIFICATES

- Technical product specifications
- Test report UNI EN10204 type 2.2

∅ D	A	B1	B2		
mm	mm	mm	mm		
3	31	7,5	14	10	082820203
4	37	10,5	14,5	10	082820204
5	44	12,5	16	10	082820205
6	51	12,5	18	5	082820206
8	68	14	23	5	082820208

 **Robur**

8284

pelican hooks
AISI 316 stainless steel



LABORATORY TESTS

- chemical analysis
- tensile test

AVAILABLE CERTIFICATES

- Technical product specifications
- Test report UNI EN10204 type 2.2

Ø C	B	L	WFL		
mm	mm	mm	kg		
6	11	73	200	3	082840006
8	14	98	300	3	082840008
10	23	143	450	1	082840010

8285

jaw terminals
AISI 316

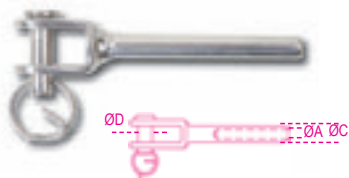

LABORATORY TESTS

- chemical analysis
 - tensile test
- ### AVAILABLE CERTIFICATES
- Technical product specifications
 - Test report UNI EN10204 type 2.2

Ø A	Ø C	Ø D	WFL		
mm	mm	mm	kg		
3	6,3	6	180	5	082850203
4	7,5	6	200	3	082850204
5	9	10	330	1	082850205
6	12,5	12	720	1	082850206
8	16	13	1120	1	082850208

8286

eye terminals
AISI 316



LABORATORY TESTS

- chemical analysis
 - tensile test
- ### AVAILABLE CERTIFICATES
- Technical product specifications
 - Test report UNI EN10204 type 2.2

Ø D	Ø A	Ø C	WFL		
mm	mm	mm	kg		
3	6,5	6,3	180	5	082860203
4	8,5	7,5	200	3	082860204
5	10,6	9	330	1	082860205
6	13	12,5	720	1	082860206
8	14,7	16	1120	1	082860208

8287

swage studs
AISI 316

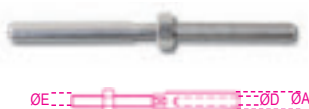

LABORATORY TESTS

- chemical analysis
 - tensile test
- ### AVAILABLE CERTIFICATES
- Technical product specifications
 - Test report UNI EN10204 type 2.2

Ø D	Ø A	E	WFL		
mm	mm	mm	kg		
3	6,3	M6	180	5	082870203
4	7,5	M8	200	3	082870204
5	9	M10	330	1	082870205
6	12,5	M12	720	1	082870206
8	16	M16	1120	1	082870208

8290

pad eyes
AISI 316

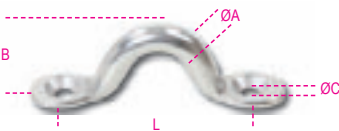

LABORATORY TESTS

- chemical analysis
- ### AVAILABLE CERTIFICATES
- Technical product specifications
 - Test report UNI EN10204 type 2.2

Ø A	B	Ø C	L		
mm	mm	mm	mm		
5	18	4,3	40	5	082900205
6	22	5,2	44	5	082900206
8	23	5,2	51	5	082900208

8381SX

U bolts for pipes

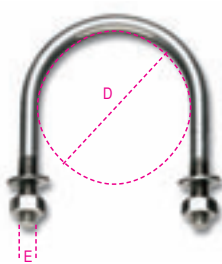

AISI 304

LABORATORY TESTS

- chemical analysis
- ### AVAILABLE CERTIFICATES
- Test report UNIEN10204 type 2.2

D	D	E		
mm	gas	mm		
11	1/8"	M6	20	083810401
14	1/4"	M6	20	083810402
18	3/8"	M6	20	083810403
22	1/2"	M6	20	083810404
27	3/4"	M6	20	083810405
34	1"	M6	20	083810406
43	1"1/4	M6	20	083810407
49	1"1/2	M8	10	083810408
61	2"	M8	10	083810409
77	2"1/2	M8	10	083810410
89	3"	M8	10	083810412
115	4"	M8	10	083810413
168	6"	M10	1	083810416
220	8"	M10	1	083810418

8293

ratchet tie downs AISI 304
high-tenacity polyester belt, LC 300 kg,
with hooks

hangable

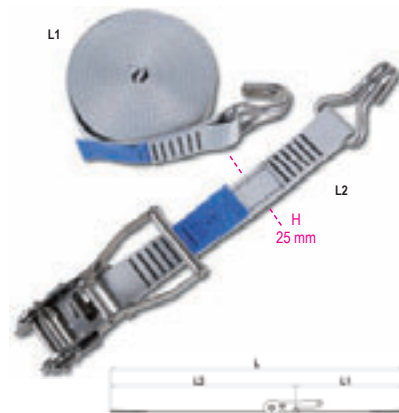

L	L2	L1		
m	mm	mm		
6	5700	300	1	082930106

LC = 300 kg

8297C

ratchet tie downs,
with mini-ratchets, AISI 304
high-tenacity polyester belt, LC 700 kg

hangable

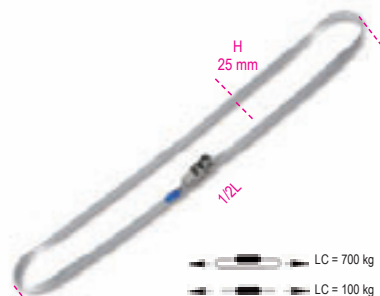

L	H		
m	mm		
5	25	1	082970350

LC = 700 kg

8297F

2 cam buckle straps,
AISI 304,
high-tenacity polyester belt, LC 250 kg

hangable

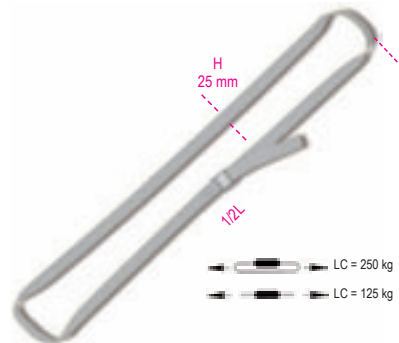

L	H		
m	mm		
3	25	1	082970230

LC = 250 kg

Special packaging for
your free-service sales
+ CE declaration of
conformity
+ instruction for use



8001Z-K

CE



Ø mm			
M5	2	1	080019305
M6	2	1	080019306
M8	1	1	080019108
M10	1	1	080019110
M11	1	1	080019111
M12	1	1	080019112
M14	1	1	080019114
M16	1	1	080019116
M18	1	1	080019118
M20	1	1	080019120
M22	1	1	080019122
M24	1	1	080019124

8001TZ-K

CE



Ø mm			
M12	1	1	080019512
M16	1	1	080019516
M20	1	1	080019520
M24	1	1	080019524

8005Z-K

CE



Ø mm			
M5	2	1	080059305
M6	2	1	080059306
M8	1	1	080059108
M10	1	1	080059110
M11	1	1	080059111
M12	1	1	080059112
M14	1	1	080059114
M16	1	1	080059116

8005TZ-K

CE



Ø mm			
M12	1	1	080059512

8006Z-K

CE



Ø mm			
M5	2	1	080069305
M6	2	1	080069306
M8	1	1	080069108
M10	1	1	080069110
M11	1	1	080069111
M12	1	1	080069112
M14	1	1	080069114

8007Z-K

CE



Ø mm			
M5	2	1	080079305
M6	2	1	080079306
M8	1	1	080079108
M10	1	1	080079110
M11	1	1	080079111
M12	1	1	080079112

8008N-K

CE



Ø mm			
M5	2	1	080089305
M6	2	1	080089306
M8	1	1	080089208
M10	1	1	080089210
M12	1	1	080089212
M14	1	1	080089214

8009Z-K

CE



Ø mm			
M8	1	1	080099008
M10	1	1	080099010
M12	1	1	080099012

8009TZ-K

CE



Ø mm			
M12	1	1	080099512

8010Z-K

CE



Ø mm			
M8	1	1	080109008
M10	1	1	080109010
M12	1	1	080109012
M14	1	1	080109014

8105-K

CE



ØxE "			
3/8x6	1	1	081059010
1/2x9	1	1	081059012

Robur

8109-K

CE



ØxE			
3/8x6	1	1	081099010
1/2x9	1	1	081099012

8016-K

CE



Ø mm			
3	6	1	080169403
5	4	1	080169405
6	4	1	080169406
8	4	1	080169408
10	2	1	080169410
11	1	1	080169011
12-13	1	1	080169013
14	1	1	080169014
16	1	1	080169016
18	1	1	080169018
20	1	1	080169020
22	1	1	080169022
24-26	1	1	080169026

8016FR-K

CE



Ø mm			
3	6	1	080169753
5	6	1	080169755
6	4	1	080169756
8	4	1	080169758
10	2	1	080169760
13	2	1	080169763

8016U-K

CE



Ø mm			
5	4	1	080169805
6	4	1	080169806
8	4	1	080169808
10	2	1	080169810
12	1	1	080169612
14	1	1	080169614
16	1	1	080169616
19	1	1	080169619
22	1	1	080169622
26	1	1	080169626

8025-K

CE



Ø mm			
5	4	1	080259205
6	4	1	080259206
8	2	1	080259208
10	2	1	080259210
11	1	1	080259011
12	1	1	080259012
14	1	1	080259014
16	1	1	080259016
18	1	1	080259018
20	1	1	080259020
22	1	1	080259022
25	1	1	080259025

8026A-K

CE



Ø mm			
12	1	1	080269012
14	1	1	080269014
16	1	1	080269016
18	1	1	080269018
20	1	1	080269020
22	1	1	080269022
25	1	1	080269025

8026R-K

CE



ØA mm			
13	1	1	080269212
16	1	1	080269216

8028-K

CE



Ø mm			
5	4	1	080289305
6	4	1	080289306
8	2	1	080289308
10	2	1	080289310
11	1	1	080289111
12	1	1	080289112
14	1	1	080289114
16	1	1	080289116
18	1	1	080289118
20	1	1	080289120
22	1	1	080289122

8029R-K

CE



ØA mm			
6	1	1	080299106
8	1	1	080299108
10	1	1	080299110
11	1	1	080299111
13	1	1	080299112
16	1	1	080299116

8031R-K

CE



ØA mm			
13	1	1	080319112
16	1	1	080319116

8032-K

CE



ØA mm			
13	1	1	080329012
16	1	1	080329016

8040EN-K

CE



Ø mm			
M6	4	1	080409506
M8	4	1	080409508
M10	2	1	080409510
M12	1	1	080409312
* M14	1	1	080409314
M16	1	1	080409316
* M18	1	1	080409318
M20	1	1	080409320
* M22	1	1	080409322
M24	1	1	080409324
* M27	1	1	080409327
M30	1	1	080409330

8040EZ-K

CE



Ø mm	W	U	U
M6	4	1	080409606
M8	4	1	080409608
M10	2	1	080409610
M12	1	1	080409412
* M14	1	1	080409414
M16	1	1	080409416
* M18	1	1	080409418
M20	1	1	080409420
* M22	1	1	080409422
M24	1	1	080409424
* M27	1	1	080409427
M30	1	1	080409430

8041-K

CE



Ø mm	W	U	U
* M8	1	1	080419208
* M10	1	1	080419210
* M12	1	1	080419212

8042EN-K

CE



Ø mm	W	U	U
M6	4	1	080429506
M8	4	1	080429508
M10	2	1	080429510
M12	1	1	080429312
* M14	1	1	080429314
M16	1	1	080429316
* M18	1	1	080429318
M20	1	1	080429320
* M22	1	1	080429322
M24	1	1	080429324
* M27	1	1	080429327
M30	1	1	080429330

Robur

8042EZ-K

CE



Ø mm	W	U	U
M6	4	1	080429606
M8	4	1	080429608
M10	2	1	080429610
M12	1	1	080429412
* M14	1	1	080429414
M16	1	1	080429416
* M18	1	1	080429418
M20	1	1	080429420
* M22	1	1	080429422
M24	1	1	080429424
* M27	1	1	080429427
M30	1	1	080429430

8043-K

CE



Ø mm	W	U	U
* M8	1	1	080439208
* M10	1	1	080439210
* M12	1	1	080439212

8051S-K

CE



WLL kg	W	U	U
250	1	1	080519202
500	1	1	080519205

8216-K

CE



ø F mm	W	U	U
2	4	1	082169402
3	4	1	082169403
4	4	1	082169404
5	2	1	082169405
6	2	1	082169406
8	2	1	082169408
10	2	1	082169410

Robur

Beta Collection

A range of exclusive products designed and developed to epitomize Beta's character, it comprises over 200 original, first-rate items: sports equipment, technical clothing and a variety of tailored objects.

An ideal medium for promotional actions, a must for recreational moments.



9572MB

Beta-March F1 vintage T-shirt, 100% cotton



S	1	095720701
M	1	095720702
L	1	095720703
XL	1	095720704
XXL	1	095720705

9507U

men's sweatshirt, made of CVC fleece fabric, 60% cotton and 40% polyester, with hood and long zip



M	1	095070052
L	1	095070053
XL	1	095070054
XXL	1	095070055

9510

short-sleeved shirt, 100% poplin cotton, 110 g/m², orange fabric inserts and white piping trim, contrasting orange button, reflective heart-side logo and back print



XS	1	095100000
S	1	095100001
M	1	095100002
L	1	095100003
XL	1	095100004
XXL	1	095100005

9504

windproof/rainproof softshell jacket, black exterior / orange interior, orange and grey fabric insert on one shoulder, thermo-taped zips, reflective heart-side logo and back print



9507D

women's sweatshirt, made of CVC fleece fabric, 60% cotton and 40% polyester, with hood and long zip



S	1	095070061
M	1	095070062
L	1	095070063
XL	1	095070064

9533N

polyester shirt, breathable, 175 g/m², black



S	1	095330051
M	1	095330052
L	1	095330053
XL	1	095330054
XXL	1	095330055

9505

sleeveless windproof/rainproof softshell jacket, black exterior / orange interior, orange and grey fabric insert on one shoulder, thermo-taped zips, reflective heart-side logo and back print



9508K

long zip jacket, ripstop nylon, waterproof, folds into pocket



S	1	095080011
M	1	095080012
L	1	095080013
XL	1	095080014

9534W

three-button polo shirt, carded pique cotton 220 g/m², white



S	1	095340011
M	1	095340012
L	1	095340013
XL	1	095340014
XXL	1	095340015

9534B

three-button polo shirt,
carded pique cotton 200 g/m², blue



S	1	095340051
M	1	095340052
L	1	095340053
XL	1	095340054
XXL	1	095340055

9537N

fleece pullover, black, 100% polyester



M	1	095370102
L	1	095370103
XL	1	095370104
XXL	1	095370105

Beta

9564B

polyester necktie, blue



9564B 1 095640011

9564G

polyester necktie, grey



9564G 1 095640021

9564X

polyester slim necktie, bordeaux



9564X 1 095640031

9580S

sunglasses "Summer" style

CE



EN ISO 12312-1:2013+A1:2005
EN ISO 12311:2003
UV400
CAT. III

9580S 1 095800100

9593CV

quartz chronograph, 42.5 mm steel case,
5 ATM water resistant, calendar, leather strap



9593CV 1 095930115

9593CA

chronograph, steel case, 5 ATM water
resistant, leather strap



9593CA 1 095930025

9593B

analogue watch, soft touch plastic case,
with metal ring, 3 ATM water resistant,
silicone strap



9593B 1 095930130

Beta

9544

hard, cabin-sized trolley



9544

1 095440100

9545

PC trolley



9545

1 095450100

9557J 2.0

bag made of coated polyester/Oxford 600D polyester fabric, dimensions 47x28x25 cm



9557J 2.0

1 095570020

9557J 3.0

bag made of coated polyester/Oxford 600D, dimensions 58x29x36 cm



9557J 3.0

1 095570030

9557SB

sports bag with shoe compartment, made of coated polyester/Oxford 600D polyester fabric, dimensions 46x21x37 cm



9557SB

1 095570050

9557N

"Racing" bag, made from waterproof PVC coated fabric



80x35x35

1 095570001



9541F

rucksack made of coated polyester/Oxford 600D polyester fabric, dimensions 50x33x16 cm



9541F

1 095410011

9541BIKE

rucksack made of Oxford polyester, dimensions 41x24x16 cm



9541BIKE

1 095410021

95740

work gloves



M

1 095740202

L

1 095740203

XL

1 095740204

XXL

1 095740205

9574B

work gloves



M

1 095740102

L

1 095740103

XL

1 095740104

XXL

1 095740105

9525C

Ottoman cap, 100% breathable polyester, black, one-size-fits-all adjustable buckle strap



9525C 5 095250051

9525R

cap, 100% breathable polyester, black, one-size-fits-all adjustable buckle strap



9525R 5 095250071

9525/N

cap, 100% cotton, one-size-fits-all adjustable buckle strap, directly embroidered front, sides and back, black



9525N 5 095251021

9525/B

cap, 100% cotton, one size-fits-all adjustable buckle strap, directly embroidered front, sides and back, white



9525B 5 095251031

9521

umbrella, nylon T210, 3-section aluminium frame, automatic open/close mechanism



9521 1 095210000

9521W

umbrella made of nylon 210T, diameter 100 cm



9521W 1 095210111

9599CB

Atala® city bike, 49 cm aluminium frame, Shimano® 6 speed gear, V-brake®, 28" aluminium rims



9599CB 1 095990011

9599CB-W

Atala® city bike, aluminium frame, Shimano® 6-speed gear, V-Brakes® 28" aluminium rims



9599CB-W 1 095990023

9598A

Atala® mountain bike, aluminium frame, suspension fork with mechanical lockout, Shimano® Acera 24 speed gear, hydraulic disc brakes, 29" aluminium rims



9598A M 1 095980100
9598A L 1 095980102

9598B

Whistle® mountain bike, monocoque carbon frame, Suntour fork with remote lockout, Shimano XT 20 speed gear, Deore derailleur and controls, Shimano hydraulic brakes, 27.5" aluminium rims



	H cm	
9598B S	160÷170	1 095980198
9598B M	170÷180	1 095980200
9598B L	180÷195	1 095980202

9539C/B

protective cycling helmet, outer cap made of polycarbonate, inner cap made of black, high-density EPS, adjustable size 54-62, circumference wheel adjustment



M 1 095390000
L 1 095390001

9542M

short-sleeved jersey, breathable microfibre fabric, long, covered zip, three rear pockets, including one with zip, silicone elastic at jersey end

REGULAR FIT



S	1	095420051
M	1	095420052
L	1	095420053
XL	1	095420054
XXL	1	095420055
XXXL	1	095420056

9542C

Lycra bib shorts, silicone elastic at leg end, antibacterial seat padding

REGULAR FIT



S	1	095420061
M	1	095420062
L	1	095420063
XL	1	095420064
XXL	1	095420065
XXXL	1	095420066

Beta

9542G

winter jersey, breathable fabric, raised inside, long zip, three rear pockets, silicone elastic at jersey end



S	1	095420012
M	1	095420013
L	1	095420014
XL	1	095420015
XXL	1	095420016
XXXL	1	095420017

9542S

winter underpants, raised Lycra, antibacterial, high-breathability seat padding



S	1	095420022
M	1	095420023
L	1	095420024
XL	1	095420025
XXL	1	095420026
XXXL	1	095420027

9542A

sleeveless wind stopper jacket, breathable bound fabric, long zip



S	1	095420032
M	1	095420033
L	1	095420034
XL	1	095420035
XXL	1	095420036
XXXL	1	095420037

9542AL

waterproof windbreaker, long-sleeved, made of breathable fabric



S	1	095420042
M	1	095420043
L	1	095420044
XL	1	095420045
XXL	1	095420046
XXXL	1	095420047

Beta

Beta

9543S

biking jersey and bib shorts, short-sleeved jersey, breathable microfibre fabric, long, covered zip, three rear pockets, silicone elastic at jersey end; Lycra bib shorts, silicone elastic at leg end, antibacterial, high-breathability seat padding



S	1	095430002
M	1	095430003
L	1	095430004
XL	1	095430005
XXL	1	095430006
XXXL	1	095430007

9543W

biking jersey and bib shorts, short-sleeved jersey made of breathable microfibre fabric, long, covered zip, three rear pockets, silicone elastic at jersey end; Lycra bib shorts, silicone elastic at leg end, antibacterial, high-breathability seat padding, white



S	1	095430102
M	1	095430103
L	1	095430104
XL	1	095430105
XXL	1	095430106
XXXL	1	095430107

9597P

column pump with gauge



9597P	1	095970100
-------	---	-----------

9524SC

miniature Beta garage for collectors



1:43	1	095240043
1:18	1	095240018

9547WSK

"Kinder Work Station", workbench with tools, for children from 3 years of age



9547WSK	1	095473801
---------	---	-----------

9547T

"Kinder trolley", tool trolley, for children from 3 years of age, complete with tools



9547T	1	095470100
-------	---	-----------



9561V

sail flag, 4x0.75 m,
with chrome-plated metal pole,
grit concrete base, 50 cm



9561V 1 095610001

9559

one-sided banner, TNT; modules: 3x0.8 m



9559 1 095591001

9559/30MT

nonwoven fabric roll of 10 Beta logos



9559/30MT 1 095591031

9590B

flag, made of screen-printed nylon



9590B 1 095900000

9582LE

luminous sign, one-sided, for outdoor use



9582LE 1 095820010

9582LI

luminous sign, two-sided, for indoor use



9582LI 1 095820050

9577M

overalls, T/C twill, polyester/cotton (65/35),
240 g/m2



S	1 095770051
M	1 095770052
L	1 095770053
XL	1 095770054
XXL	1 095770055
XXXL	1 095770056

9579C

work jacket, polyester/cotton



M	1 095791002
L	1 095791003
XL	1 095791004

9575

suction cup folder,
made from plasticized fabric,
with four suction cups on upper side



9575 1 095750001

9563P

office armchair, black



9563P 1 095630010

9549PB

portable battery, ultrathin, 5400 mA



9549PB 1 095490051

9549USB

USB key, 8 GB



9549USB 1 095490061



9547

desk calculator



9547

1 095470000

9594

clock complete with thermometer and hygrometer, 26 cm in diameter



∅
cm
26

1 095940051

9526P

espresso coffee machine with capsules

Compatible with Lavazza™ and Espresso Point™ capsules



9526P

1 095260010

9527 6T

set of 6 coffee cups



9527 6T

1 095270001

9527MUG

mug with cover and silicone sleeve



9527MUG

1 095270020

9581

petrol lighter



9581

1 095811001

9586K

multipurpose steel knife, 10 functions



9586K

1 095860100

9592B/C50

set of 50 pens



9592B/C50

1 095920050

9592B/P

customised pens



9592B/P

500 095920051

9588M

soft foam tray with 1 pen and 2 notebooks



9588M

1 095880011

9596

badge holder, polyester, with metal clip and mobile phone string



9596

10 095961001

9595C

leather key ring



9595C

1 095950011

9595T

metal chrome-plated key ring, in velvet pouch



9595T

1 095950021

9595 C25

metal chrome-plated key ring with rubber hook



9595 C25 1 095950031

9569P

shopper, made of polyethylene, folded sides



9569P 44x34 50 095691001

9569S

TNT shopper with folded sides, 38x42 cm



9569S 50 095690051



9587 9x14

notebook, 9x14 cm



9587 9X14 5 095870009

9587 13x21

notebook, 13x21 cm



9587 13X21 5 095870013

9588S/10...

set of 10 notepads



9588S/10A	21x29 cm	1 095881001
9588S/10B	15x21 cm	1 095881002
9588S/10C	10x15 cm	1 095881003
9588S/10D	7,5x10,5 cm	1 095880054

9588/10PI

set of 10 notepads with adhesive sheets



9588S/10PI 1 095880055

9589A/36

pack of 36 rolls of packaging adhesive tape, with Beta logo, tawny



9589A/36 1 095890035

9589B/36

pack of 36 rolls of packaging adhesive tape, with Beta logo, white



9589B/36 1 095890036



FIELDS OF USE FOR TORQUE WRENCHES

1 Nm = 0,10197 Kgfm = 0,7375 lbf.ft



Size	Model	Capacity (Nm)	Resolution (Nm)	Capacity (Kgfm)	Resolution (Kgfm)	Capacity (lbf.ft)	Resolution (lbf.ft)
1/4"	590	0,3	4				
	590/1	0,5	13,5				
	603/5	1	5				
	603/10	2	10				
	605E/5	1	5				
	605E/10	2	10				
	666N/2		5 25				
3/8"	592/3	1	27				
	592/4		3 40				
	599DGT/6		12 60				
	666N/2X		5 25				
	606/6		8 60				
	606/10		20 100				
	666N/5		10 50				
	666N/10		20 100				
	666N LBF.IN/5		90 LBF.IN 440 LBF.IN				
666N LBF.IN/10		200 LBF.IN 800 LBF.IN					
1/2"	594/8		6 80				
	594/21		20 215				
	599DGT/10X		20 100				
	599DGT/20		40 200				
	599DGT/30		68 340				
	599DGT-A/10		20 100				
	599DGT-A/20		40 200				
	606/10X		20 100				
	606/20		40 200				
	606/30		60 330				
	606MQ/50		5 50				
	666N/10X		20 100				
	666N/20		40 200				
	666N/30		60 300				
	666N LBF.IN/10X		200 LBF.IN 800 LBF.IN				
	666N LBF.IN/20		400 LBF.IN 1800 LBF.IN				
	666N LBF.IN/30		500 LBF.IN 3000 LBF.IN				
	667N/20		40 200				
	667N/30		60 300				
3/4"	596/40SL		80 400				
	596/80SL		160 800				
	667N/40		80 400				
	677/50 677C/50		100 500				
	677/70 677C/70		150 700				
	677/100 677C/100		300 1000				
	677C/150		700 1500				
	678C/65		130 650				
	678C/100		300 1000				
678C/150		500 1500					
1"	598/200SL		400 2000				
	677/CP200		900 2000				





Adjustable wrenches	27, 221, 230
Amperometric clamps	151
Assortments of tools in thermoformed trays	377÷397
Auto-darkening LCD mask	162
Automatic cable reels with inspection lamps	160
Automatic hose reel for compressed air or cold water	248
Barrel pumps	164
Beta Collection	494÷503
BetaEasy screwdrivers	109÷111
BetaGrip screwdrivers	114÷116, 223
BetaMax screwdrivers	117÷120, 225, 232
Bevel protractor	137
Bit reamers	142
Bits and bit holders	28, 63÷70, 112-113, 221
Bits for drilling, threading and countersinking	43
Blister pack range	400÷411
Bolt cutters	102
Bonding guns	148
Bottle holders	271
Bristle brush	146
Brushes	146, 234
Cable cutters	105
Cable cutters for steel cables	105
Cable stripping tools and wire stripping pliers	105-106
Callipers	137
Cape chisels	16
Carpenter's pencil	138
Centre punches	15
Chalk line reels and powder	140-141
Circlip pliers	97-98, 232
Combination pliers	106, 222, 232
Combination wrenches	16-17, 28-29, 225, 228
Crimping pliers for terminals and terminals	130÷133
Crowfoot wrenches, 3/8" square drive	77
Cutting nippers for electronic purposes	108-109
Desoldering pumps	156
Diagonal and end cutting nippers	101-102, 108-109, 222, 232
Dial indicators	135
Dies and assortments	44÷47
Digital litre counter for oil	164
Digital tachometer	152
Display units for sales points	412÷424
Double ended hexagon / bi-hex offset socket wrenches	91-92, 231
Double swivel end socket wrenches	20
Double-ended offset ring wrench for scaffolding bolts	21, 229
Drift punches	15, 228
Ear protectors	460
Electrician's scissors	104, 222
Electronic torque meter with Dynatester transducer	51, 57
Electronic videoscope	172-173
Engineer's scribes	138
Extractors for damaged screws and studs	124-125
Extra-flat chisels with straight cutters	175, 177
Files	40, 177, 142÷145, 234
Filtering mask	460
Fitting tool for ties and ties	148



Fixed frame hacksaw	145
Flare nut open ring wrenches	21, 28-29
Flat chisels	15, 228, 233
Flexible magnetic pickup tools	141
Flexible pickup tools	141
Fluid extractor	164
Friction tape	133
Graduated rules	137
Hacksaw frames and blades	145
Hammers	120÷124, 232-233
Hand crimper steel matrix	101
Hand punch steel punch and matrix	101
Hand sockets, accessories and assortments, 1/4"	70÷74
Hand sockets, accessories and assortments, 3/8"	75÷79
Hand sockets, accessories and assortments, 1/2"	80÷88, 221, 230-231
Hand sockets, accessories and assortments, 3/4"	89-90, 231
Hand sockets, accessories and assortments, 1"	90
Hand taps and assortments	41÷43, 45÷47
Heat guns	160-161
Heating plates for manual straight and slanted welding of plastic pipes	30
Heavy-duty cable cutters	102
Hi-torque hexagon nut spinners with handles	92-93, 221-222
Holesaws and hole cutters and accessories	47-48
Hook wrenches	27, 230
Hot glue guns	161
Hub and wheel drum pullers	202
Hydraulic press	128
Hydraulic pullers	128-129
Impact screwdrivers	119
Impact sockets, accessories and assortments	58÷63
Industrial tool chests	280÷282
Inspection mirrors	141-142
Insulated tools, 1000V	220÷223
Insulating gloves	223
Insulating mat	223
Kneeling pad	165
Knives	154-155, 234
Lamps	156÷160, 299, 320
Lever clamps	129
Lever operated grease guns	148-149
Lever-operated grease gun	149
Lifting airbag	155
Locking wire pliers	152
Long and extra-long nose pliers	97, 106-107, 222-223, 232
Lump hammers	122, 233
Magnetic tool holders	153
Magnetizer/demagnetizer	109
Mains testing screwdrivers	112
Masonry chisels	140, 233
Measuring tapes	138-139
Metric feeler gauges	141
Micrometers	135
Microscrewdrivers	112÷114
Mobile roller cabs	261÷279, 282÷290, 312
Mobile workstation	276
Morse taper extractors	40
Multilayer pipe gauge	32



Multimeters	150-151
Nut splitters	141
Nylon clamps	148
Nylon wire puller	133
Offset key wrenches for hexagon and Torx® head screws, with high torque handles	25÷27, 94-95, 225, 222
Offset key wrenches for hexagon and Torx® head screws	22÷27, 225, 229
Offset key wrenches with XZN® profile	27
Offset screwdrivers	112
Oil cans	149-150
Oil gun	164
Oil pressure pump	120
Panel toolholders	299-300, 315-316
Paper roll holders	271
Parallel bench vices	129-130
Pen oiler	150
Pin punches	15, 228
Pincers	102
Pipe benders	35
Pipe cutters	30-31, 230
Pipe reamers	32
Pipe wrenches	34-35, 230
Pivoting clamp vices, for plumbing purposes	39
Plastic repair kit	179
Pliers for electronic purposes	107-108
Plumbing tools	29÷36
Pneumatic tools and accessories	235÷250
Polywelders and forms	30
Portable tool chests	259-260, 283
Protractors	137
Pry bars	140, 173, 231
Pullers	124÷129
Punch press	133-134
Punches	103
Radius gauges	141
Ratcheting wrenches	28÷30
Ratchet-type shears for PVC pipes	31-32
Reversible screwdrivers	116-117
Revolving punch pliers	153
Ring wrenches	20÷22, 28÷30, 221, 229
Riveting pliers and rivets	146÷148
Robur wire rope accessories	462÷493
Safety footwear	425÷447
Safety goggles	460-461
Scissors	104-105, 155, 222, 234
Scrapers	191, 142, 154, 234
Screw clamps	129
Screw pitch gauge	141
Screwdrivers with steel heads	112
Screwholding screwdrivers	112
Seat with castors	164-165
Self-locking pliers	99-100
Shears	103-104
Single and double open end wrenches	17÷19, 221, 228
Sledge hammers	122-123, 233
Slip joint pliers, boxed joints	98-99, 106, 222, 232
Slogging wrenches	19, 228-229
Soft face hammers	123-124, 233



Soldering irons	155-156
Sparkproof axe	233
Sparkproof pick	234
Sparkproof safety valve wrenches	231-232
Sparkproof shovel	234
Sparkproof tools	227÷234
Special end mills for welding	39
Spirit levels and levelling staffs	139-140
Spring puller	145
Spring tweezers	95÷97
Squares	136-137
Stainless steel helicoids	43, 167-168
Stainless steel tools	224÷226
Stepped drills	39-40
Suction lifters	153
Support for impact wrenches	237
Tap wrenches and die stocks	43, 45
T-handle socket wrenches for hexagon and Torx® head screws	93÷95
T-handle wrenches with three male ends for hexagon and Torx® head screws	94-95, 222
Thermoformed tool trays	377÷397
Thermometers	152
Three-leg pullers	126-127, 129
Tool accessories for cabinets, drawers and panels	397÷399
Tool assortments	321÷397
Tool bags	252÷256
Tool boxes	255÷258
Tool cabinets	295-296
Tool cabinets, sheet metal	318-319
Tool cases	252÷254
Tool chest trolleys	261
Tool pouches with belts	252
Tool rucksack	255
Tool trolleys, 2 wheels	252÷256, 291÷293
Tool trolleys, 4 wheels	272, 274-275, 294
Tool trunks	258
Torches	156-157
Torque angle indicators	52
Torque bars	53, 55-56
Torque multipliers	49-50
Torque screwdrivers	50-51
Torque wrenches and bars	51÷57
Tube flaring tools	32-33
Tubular socket wrenches	91-92
Twist drills with cylindrical shanks	36÷39
Two-leg pullers	125÷128
Ultrasonic cleaning tank	164
Utility knives	153-154
Vacuum cleaners for solid and fluid	162-163
Vehicle repair	166÷219
Voltage tester	152, 199
Welding machines	162
Wood rip saw	145
Workbenches	297÷309
Workshop Equipment	304÷320
Workshop verniers	134-135
Workwear	448÷461

Automotive

INDEX OF CAR VEHICLE TOOLS



Acid densimeter, glass body	207
Adjustable body blade holders with flexible flat blades	177
Air hydraulic jack	219
Antifreeze densimeter, glass body	207
Ball joint pullers	204-205
Battery chargers	200-201
Battery fillers	206
Battery lug and post cleaner steel brush	146
Brake fluid extractor	186
Brake spring pliers	187
Chain opening tool	205
Claw hammers	177
Clip pliers	209
Clutch aligners	179
Compressors for shock absorber springs	203
Cooling system seal testers	207
Creepers	213-214
Curved angled spoons	176
Dent puller	178
Dent reflector	178
Diesel injector test and calibrating hand pump	172
Digital pressure and compression tester	185
Dollies	175-176
Engine brackets	215
Engine oil-filter wrenches	195-197
Exhaust pipe expanders	189
Exhausted oil drain units	211
External butt-ended circlip pliers	180
Feeler gauges for car body repair shops	177
Fluid collection tank	211
Folding hydraulic crane	215
Four-way hexagon wheel nut wrenches	174
Gas oil filter wrenches	197
Gauge for tyre threads	141
Heavy vehicle tools	173-174, 204-205
Heavy vehicle wheel hub nut locking sockets	174
Homokinetic joint pullers	205
Hose clamp pliers	188-189
Hose pliers	191-192
Hydraulic bottle jacks	215
Hydraulic car jack with wheels	217
Hydraulic pit and under bridge jack	216
Hydraulic press	216
Impact sockets for axle nuts	173-174
Impact sockets for wheel nuts	168
Instrument for controlling compression on petrol and Diesel engines	170
Jack and positioner for truck wheels	214
Jack stands	214
Kit for filling diesel oil filters	191
Leaf spring pin sockets	204
Lever for DSG gearbox	179
Lever for removing wishbone heads from pillar	205
Male guide pins for wheel installation	175

INDEX OF CAR VEHICLE TOOLS



Motorcycle stands	218
Oil seal wrenches	197-198
Packing removal tool	127
Parking sensor punches	178
Piston ring compressors	180
Plastic funnel	206
Pneumatic dent puller	178
Pneumatic valve grinder	180
Quick coupler pliers for fuel pipes	192
Reamers for cleaning injector seats	172
Rubber-covered aluminium foil, formable	206
Sliding gauges for brake discs and drums	134
Sockets for Diesel engine injectors	169
Sockets for Lambda probes	170
Sonoscope probe	202
Spark plug pliers	189
Spark plug wrenches and sockets	168-169
Spring pulling hook wrenches	124, 145
Square impact sockets for Isuzu wheel nuts	61
Starters	199-200
Stopping knives made of stainless steel	177
Striking tools for installing conical bearings and oil seals	206
Telescopic rod	210
Tester for batteries and recharging systems	201
Timing devices	181÷185
Tool for disc brake pistons	187
Tool for removing and inserting silentblocks	205-206
Tools for airbag	179
Tools for air-conditioning systems	193
Tools for common rail diesel injector	169-170
Tools for pulling out car radios	209
Tools for releasing electrical connectors	197
Tools for removing broken glow plugs	171-172
Tools for removing glass windows	209-210
Tools for spark plug coils	189
Tools for tyre valves	175
Torsion bars for wheel nuts	62
Trim pin removers	190-191
Tyre inflator	248
Tyre levers	173
Tyre pressure sensor tool	174
Underbody trolley for vehicles	214
Valve depressors for disc removal	186
Valve seat removing tool	180
Valve spring compressors	180
Valve timing system pulley locking tools	185
Vapour extractor	172
Voltage stabilizer	201
Voltage tester	199
Wheel balancing weight tool	175
Wheel hub nut locking sockets	173
Wheel lifter	214
Wheel nut plastic cap pliers	175
Window trim tool remover	210
Wrench for natural gas cylinder valves	194
Wrench for removing steering arms	205
Wrench for turbines	190
Wrenches for fuel connectors	184
Wrenches for fuel tank floating ring nuts	192

ALPHANUMERIC INDEX

30	15	96BPA	25	338RP	31	415/C116	38	451	48
30BA	228	96BPA/SC9	25	339A	31	415/SP91	39	451GA	48
31	15	96BPC	24	339A/R	31	415/SP	38	451PA	48
31BA	228	96BPC/SC9	24, 401	341	31	416	39	451PR	49
31BM	15	96N	22	341B	31	416/SP19	39	452	49
31L	15	96N/SC9	23	341B/RL	31	417	39	452GA	49
31SE	15	96N/SC12	23	341B/RM	31	417/SP	39	560/C2	49
32	15	96N/ST6K	401	341RL	31	419	39	560/C4+	49
32BA	228	96C/AS	23, 401	342	32	423	39	560/C6	49
32AU	15	96C-AS/SC9	23	342A	32	423A	39	560/C12	49
32AUR	15	96L	24	342A/MOL	32	424	39	561/1	49
34	15	96LBP	24	342A/RL	32	424/SP	40	562/1 - 562/2	50
34BA	228	96LBP/SC9	24, 401	342MOL	32	425	40	564/3R - 564/4R	50
35	15	96LC	23	342P	32	425/SP	40	565/1R - 565/2R -	50
35PM	15	96LC/SC8	23	342P/RL	32	426	40	565/3R	
35PMR	15	96LC/SC12	23	342RL	32	426/SP	40	565/4R	50
36	16	96T	25, 402	345	32	426SB	40	565/5R	50
37	16	96T/S6	25	345C	32	426SB/SP	40	567/4R	50
37PM	16	96T/S11	25	345SB	32	426MD	40	567/5R	50
37PMR	16	96TBP	25	345SB/R	32	426MD/SP10	40	581	50
38/DS1	413	96TBP/S6	25	345U	32	427	40	583	51
38/DS2	413	96TK	402	349	32	428FC	41	583/C31	51
39BA	228	97BTX	26	349/SMAS	32	428FP	41	588	51
42	16	97BTXL	26	349/SMM	32	428/C14	41	590 - 592	51
42/SC9I-E	16	97BTX/SC8	26, 402	350	33	429FC	41	594	51
42AS	17	97BTXL/SC8	26, 402	351C	33	429FP	41	596 - 598	51
42BA	228	97RTX	26	351P	33	429/C14	41	599DGT	52
42BA-AS	228	97RTX/SC8	26	352C/U	33	430	41	599DGT-A	52
42K	401	97TX	25	352U	33	430/SP	41	600/1 - 600/2	52
42LMP	17	97TX/BG8	26	353N	33	430ASC	42	601C	52
42MP	17	97TX/SC8	26	353NM	33	430ASW	42	601CA	52
45	17	97TTX	26	353N/C6	33	430/SP	41	603	52
52	17	98XZN	27	355	33	431	42	604B	53
52MQ	221	99	27	357 F3	33	431/SP	42	605E	53
53	18	99BA	230	357 R/F3	33	433	42	606/6 + 606/30	53
55	18	99SQ	27	358	33	433ASF	42	606MQ/50	221
55K	401	99ST	27	358RL	33	433ASG	42	611	53
55AS	18	99 VN/...	27	359	34	434	42	612 + 614	53
55BA	228	100	27	359CH	34	435	43	614/50	53
55BA-AS	228	100/KIT	27	360	34	435G	43	615	53
55MP	19	110BA	230	360R/...	34	436	43	616 - 617 - 619	53
58	19	110MQ	221	362	34	436L	43	621	53
58BA	228	111	27	362R/...	34	436R	43	641	54
73	19	111G	27	363	34	437C	167	642	54
78	19	111K	402	363BA	230	437C/...	167	643	54
78AS	19	111N	27	363R/...	34	437C/RM14	167	652	54
78BA	229	120	28	365	34	437K/8	167	653	54
78BA-AS	229	123E1/4	28	365R/...	34	437K/16	168	666N	54
80	20	123Q1/4	28	366	34	437K/33	168	666N LBF.IN	55
83	20, 167	123Q3/8	28	374	34, 402	437U/09	43, 167	667N	55
83AS	20, 167	123Q1/2	28	374R/...	35	437U/E-M...	43, 167	668N	55
88	20, 167	123/K4	28, 402	375	34	437U/PM	43, 167	668RG	55
88/S7	20, 167	142	28, 402	376	34	438A	43	669N	56
89BA	229	142/SC9I-E	28	378	35	438...	43	671B/C5	56
89MQ	221	142AS	28	378BA	230	440	44	671B/C10	56
90	20	142C	29	383	35	440A	44	671N/C10	56
90AS	21	142SN	29	383R	35	440ASC	44	671N/C20	56
90BA	229	186 8-32	29	384	35	440ASF	44	671N/C30	56
90K	401	187	29	384RC	35	440ASG	44	677	56
91	21	187/B5	29	386A	35	440ASW	44	677/C	57
91BA	229	188	29	386A/RC	35	440B	44	677/CP200	57
92	21	192	29	386BA	230	441	44	677/CV - 678/CV	57
92BA	229	192/S2	29, 402	388	35	441A	44	678/C	57
93	21	194	29	388A	35	441B	45	680	57
93BA	229	195	29, 402	388C/C8	35	442	45	682	57
93C	21	195AS	29	392C	35	443	45	710	58
93K	401	195P	30	392RG/C	35	444	45	710/16	58
94	21	310	30	393	35	444G	45	710/20	58
94K	401	310B	30	395	36	446ASF/C29	46	710/21	58
95	21	310/C4	30	395T	36	446ASC/C37	46	710/25	58
95BA	229	310/C8	30	399	36	446ASG/C23	46	710/C10	58
95FTX	22	311	30	410	36	446ASW/C36	46	710/OR... - 710/SP...	58
96	22	330	30	410A	36	446/C30	45	720	58
96/BG7	22, 402	330BA	230	410AS	37	446/C48	45	720/15	59
96/BGS7	22, 401	330BA/2R	230	410MIX/SEL19	36	446/C110	46	720/16	59
96/SC9	22, 401	330R/A	30	410/SEL	36	447/C37	47	720/20	59
96/SC12	22	330R/I	30	410/SP	36	447/C53	47	720/21	59
96/ST6K	401	331L	30	412	37	447/C70	47	720/25	59
96AS	23	331LR/L	30	412A	37	450	47	720/C6	60
96AS/BG7	23	332	30	412L	38	450/C9	48	720/C12	60
96AS/SC9	23	334	31	412/C150	37	450/C13	48	720/OR... - 720/SP...	60
96BA	229	334R	31	412/SP	37	450/C21	48	720AS	58
96BA/BP	229	334R/I	31	412/SP91	37	450AD	47	720FTX	59
96BP	24	336	31	414	38	450AL	47	720FTX/SB	59
96BP/AS-SC9	24, 401	338	31	414/C116	38	450PA/1	48	720IC	168
96BP/SC9	24	338R	31	414/SP	38	450PA/2	48	720L	58
		338R/I	31	415	38	450PR	48	720L/S3	58

ALPHANUMERIC INDEX

720LC	168	862F	67	900/R55	90	920/55K	404	920RTX/SB	83
720LC/C3	168	862FA7	67, 403	900T/44	72	920/55L	85	920TX	82
720LC/S5	168	862LP	67	900TX	71	920/55LC	85	920TX/C	83
720LCL	168	862PE	67	900TX/SB	71	920/55Q	84	920TX/C17	88
720LCL/C3	168	862PH	67	902R/C6	74	920/55X	85	920TX/LSB4	82
720LS	59, 173	862PH/L	67	910/15	77	920/56A	85	920TX/SB	82
720ME	59	862PZ	67	910/16	77	920/58	85	920XZN	83
720ME/C8	59	862TX	67	910/20 - 910/21 -	77	920/C37	87	920XZN/LS	83
720MRC	168	862TX/L	67	910/22	77	920/R50	91	920XZN/SB7	83
720TC	168	866LP	67	910/25	77	920/R55	91	920XZN/SB12	83
720TC/S5	168	866PE	68	910/36A	78	920/R55LC	91	921BA	230
720TX	59	866PH	68	910/40	78	920/R55Q	91	921BA/21 -	230
720TX/C6	59	866PZ	68	910/42	78	920/R55X	91	921BA/22	230
727/C16	60	866RTX	68	910/46	78	920A	80	921BA/25	230
727/ES16	60	866TX	68	910/55	78	920A/AS	80	921BA/42	230
727/ES16TX	60	867/...	69	910/55Q	78	920A/C11	85	921BA/50	231
727/ES22	60	867/C52	69	910/58	78	920A/C12	85	921BA/R50	231
727/ES22TX	60	867PE	68	910/R55	90	920A/C12X	85	926BA	231
727/ES32	60	867PE/L	68	910/R55Q	90	920A/C17HR	88	926BA/22	231
727PI/16	60	867RIBE	69	910/R55X	90	920A/C20	86	926BA/42	231
727PI/22	60	867RIBE/L	69	910A	75	920A/C20Q	86	926BA/50	231
727PI/32	60	867RTX	68	910A/AS	75	920A/C20X	86	926BA/R50	231
728	61	867RTX/L	69	910A/C10	78	920A/C21	86	928/15	89
728/15	61	867TX	68	910A/C16	78	920A/C21X	86	928/16	89
728/16	61	867TX/L	68	910A/C16HR	79	920A/C33	87	928/20 - 928/21 -	89
728/21	61	867XZN	68	910A/C16Q	78	920A/SB8	80	928/22	89
728/22	61	867XZN/L	68	910A/C17	79	920A/SB13	80	928/25	89
728/22L	61	882	69	910A/C29	79	920A-AS/SB11	80	928/36A	89
728/25	61	882M	69	910A/SB	75	920AK	403	928/42	89
728/C10	61	882MSR	69	910A-AS/SB13	75	920AL	80	928/55	89
728/OR - 728/SP	62	882M1	69	910AL	75	920AL/SB11	80	928/R55	91
728FTX	61	882P	69	910AL/SB14	75	920AN	83	928/R55X	91
728L	61	892	69	910AN	77	920AS	81	928A	88
728LS	61	895	70	910AS	76	920AS/C10	87	928A/C12	89
728LQ	61	897	70	910AS/C13	79	920AS/C15	87	928AS	89
729	62	897L	70	910AS/L	76	920AS/C17X	88	928AS/C12	90
729/15	62, 77, 83	900	70	910AS/MBM-C18	79	920AS/L	81	928B	88
729/16	62	900/...	72	910AS/SB13	76	920AS/MBM-C21	88	928B/C12	89
729/21	62	900/16	71	910AS/SN	76	920AS/SB11	81	928ME	89
729/22	62	900/20LK	403	910ASL/SB12	76	920ASL/SB11	81	929	90
729/25	62	900/25	72	910B	75	920B	80	929/15	90
729/OR... - 729/SP...	62	900/25K	403	910B/C10	78	920B/C11	85	929/21 - 929/22	90
729L	62	900/32	72	910B/C16	79	920B/C12	86	929/42	90
729LS	62	900/35A	72	910B/C16Q	79	920B/C12X	86	929/55	90
729T	62	900/40	72	910B/C29	79	920B/C20	86	929/C8	90
730	63	900/42	72	910B/SB	75	920B/C20X	86	929/R55	91
730/15	63	900/55	72	910B/SN	75	920B/C21	86	930	91
733/15	63	900/55K	403	910BL	75	920B/C21X	86	930/C	91
850MQ	221, 402	900/58	73	910BL/SB	75	920B/C30Q	87	930/S	91
851	63	900/C11	73	910BP	76	920B/C33	87	932	91
851SR	63	900/C11HR	74	910CF	77	920B/SB8	80	932/S	91
852	63	900/C13-5	73	910CF/SB	77	920B/SB13	80	933	92
855P	63, 402	900/C13-8	73	910FTX	76	920B/SB13	80	933/S	92
860/55	64	900/C24	74	910FTX/L	76	920BL	80	935	92
860/58	64, 402	900/C39	73	910FTX/SB	76	920BP	82	935K	404
860/C27	64, 403	900/SB	70	910FTX/LSB	76	920BP/SB	82	935/S	92
860/C38P	65	900AN	72	910LP	76	920ES	83	937	92
860LP	63, 402	900AS	70	910M/35	77	920ES/SB	83	937BA	231
860MIX/A10	65, 403	900AS/C10	74	910M/55	78	920ES/XL-SB	83	937K	404
860MIX/A31	65, 403	900AS/C17-MBM	74	910M/56	78	920FTX	81	937/S	92
860PH	63, 402	900AS/L	71	910M/R55	90	920FTX/C	81	940	92
860PHZ/A10	64	900AS/MB	70	910ME	77	920FTX/L	81	941	92
860PHZ/A31	64	900AS/MB-C17	74	910ME/SB	77	920FTX/LSB	81	941/S	92
860PZ	63, 402	900AS/MBL	71	910PE	76	920FTX/SB	81	942BX	92
860PE	63, 403	900AS/SB11	70	910PE/SB	76	920LH/SB7	81	942BX/DG	413
860PE/A10	64	900BG/30	72	910PH	76	920LP	81	942BX/S	93
860PHT/A31	65	900BG/30K	403	910PT	77	920M/35	84	943BX	93
860RTX	64, 403	900BG/30C	72	910PT/SB	77	920M/35L	84	943BXX	404
860RTX/A10	65	900FL	72	910TX	77	920M/55	85	943BX/S	93
860TX	63, 403	900FTX	71	910TX/SB	77	920M/56	85	943BX/D	93
860TX/A10	64, 403	900FTX/SB9	71	920/15	83	920M/R55	91	943BX/DG	413
860TX/A31	65	900K	403	920/16	83	920ME	82	943FL	93
861/C61P	67	900L	70	920/20 - 920/21 -	83	920ME/C	82	943FL/S	93
861LP	65	900L/SB13	70	920/22 - 920/23	83	920ME/SB	82	943MQ	221
861PE	66	900LP	71	920/21K	404	920MQ/21	221	943MQ/BG	413
861PH	65	900M/35	72	920/25	84	920MQ/22	221	943MQ/S	222
861PH/C	66	900M/55	72	920/25K	404	920MQ/55A	221	944BX	93
861PZ	66	900MB	70	920/35A	84	920MQ/A	221	944BX/D	93
861PZ/C	66	900MB/C19	73	920/36A	84	920MQ/C16	221	944BX/DG	413
861RIBE	66	900MB/C28	74	920/38	84	920MQ/PE	221	944BX/S	93
861RTX	66	900MB/L	70	920/40	84	920MQ/T	221	949	93
861SP	66	900MB/SB	70	920/42	84	920PE	82	949/S6	93
861TQS	66	900ME	71	920/44	84	920PE/AS	82	950	94
861TX	66	900ME/SB8	71	920/46	84	920PE/C	82	950/S	94
861TX/C	66	900M/R55	90	920/50	84	920PE/SB	82	951	94
861TRW	66	900PH	71	920/50F	84	920PH	81	951/S	94
861XZN	66	900PT	71	920/55	84	920RTX	83	951/SP	94

ALPHANUMERIC INDEX

951AS	94	984	175	1057A	100	1134A/RL	105	1204/S	110
951AS/S	94	985/B7	175	1058	100	1136	105	1204K	407
951K	404	985F	175	1060	100	1137BA	232	1204L	110
951MQ	222	985M	175	1061	100	1137BA/RC	232	1205ES	111
951TX	94	986 48	175	1062	100	1142BM	105	1207TX	111
951TX/S	94	986 78	175	1062AL	100	1142BMK	406	1207TXK	407
952	94	987	175	1062GM	100	1142MQ	222	1207TX/D	111
952/S	95	987P	175	1063	101	1143	105	1208RTX	111
952AS	95	988/K4	175	1064	101	1143R	105	1208RTXK	407
952FTX	95	989	175	1065F	101	1144D	106	1208RTX/D	111
952FTX/S	95	990	95	1065P	101	1144D/RG	106	1209N/PZ	111
952L	95	991	95	1077	101	1144D/RL	106	1209N/PZK	407
953	95	992	95	1078	101	1144G	106	1209PZ	111
953/S	95	993	96	1080D	101	1144G/RL	106	1209PZ/S	111
953TX	95	993G	96	1082	101	1148A	106	1209PZK	407
953TX/S	95	993PL	96	1082BA	232	1148A/R	106	1229LP	111
955	168	993MQ	222	1082BM	101	1148B	106	1229LP/S	111
956C	168	994	96	1082BMK	405	1148B/R	106	1229LPH/A6	111
956E	169	994PL	96	1082K	405	1149F	106, 406	1229PH	111
956F	169	994MQ	222	1082MQ	222	1150	106	1236B	112
956L	169	994TF	96	1084	101	1150BA	232	1238B	112
957	169	996	96	1084BM	101	1150BM	106	1241	112
959	169	998	96	1084BMK	405	1150BMK	406	1242	112
959R	169	999/B	97	1084K	405	1150K	406	1243/D7	112
960	169	999	96	1084MQ	222	1150MQ	222	1250	112
960/22EP	170	999A	96	1088	101	1153	106	1251	112
960A	169	999B	96	1088BM	101	1162	106	1252/S5	112
960AD/TP2	172	999C	96	1088BMK	405	1162BA	232	1253	112, 407
960AVE	170	999D	96	1088K	405	1162BM	106	1253A	112
960AVL	172	999E	96	1088MQ	222	1162BMK	406	1254	112, 407
960BT	169	999G	96	1092V	102	1162K	406	1256/20	113
960BT/B	169	1002	97	1094V	102	1162MQ	222	1256/30	113
960CMB	170	1008	97	1095N	102	1164	107	1256/C36-2	112
960CMB/R2	170	1008BM	97	1096	102	1164BM	107	1256LP	113
960CMD	170	1009	97	1096K	405	1164BMK	406	1256PH	113
960CMD/R1	170	1009L/A	97	1098	102	1164K	406	1256PE	113
960EPC	171	1009L/B	97	1098K	405	1164MQ	223	1256PZ	113
960 E-PI/P	171	1009L/C	97	1098PL	102	1166	107	1256RTX	113
960F	169	1009L/D	97	1098PLK	405	1166BA	232	1256TX	113
960G	169	1009L/DP	97	1101	102	1166BM	107	1257BE	114
960H/C4	170	1010	97	1101	102	1166BMK	406	1257ES	113
960K/AVE	170	1010BM	97	1101R	102	1166K	406	1257ESB/S8	114
960KC-M8	171	1010MQ	222	1102	102	1166MQ	223	1257LP	113
960KC-M8/M9/M10	171	1031/S4	97	1104	102	1168	107	1257LP/S8	113
960KPC	171	1032	98	1104R	102	1168BM	107	1257PH	113
960L	169	1032BA	232	1105	103	1168BMK	407	1257LPH/S8	113
960M	170	1032K	404	1105T30	103	1168K	407	1257TX	114
960P	171	1033	98	1105T50	103	1168MQ	223	1257TX/S8	114
960PI	171	1033K	404	1105AD-50	103	1171BM	107	1260	114
960PI/P	172	1034	98	1105/C15T	103	1172BM	107	1260/S	114
960PI/S	172	1034K	404	1105/C29T	103	1172BM/P	107	1260E	114
960PMC	172	1034L	98	1112	103	1173BM	107	1260EK	408
960RPI	172	1036	98	1112K	405	1175BM	107	1260K	407
960S	170	1036BA	232	1114	103	1177BM	108	1260N	114
960SL	170	1036K	404	1118	103	1177BM/Z	108	1260NK	408
960SN	170	1037	98	1120A	103	1178BM	108	1262	114
960UC	171	1037K	404	1120ARL - ARG	103	1178BM/P	108	1262/S	114
961BA	231	1038	98	1122	104	1182BM	108	1262E	115
961D	172	1038K	404	1122K	405	1183BM	108	1262EK	408
961D/CF3,8	172	1039	98	1123	104	1184BM	108	1262K	408
961D/DC8,5	172	1558/C4	98	1123K	405	1185BM	108	1262NK	408
961P6	173	1044	98	1124	104	1186BM	108	1262L	115
961P6/S-2	173	1044F	98	1124K	405	1188BM	109	1262N	114
962	173	1044FK	404	1125	104	1190BM	109	1263/E39	415
963	173	1044K	404	1126	104	1191BM	109	1263/E40	415
963BA	231	1046	98	1122 - 1125MOL	104	1191BM/L	109	1263/E50	415
964	173	1046BA	232	1127	104	1191R/5-M	109	1263/E62	415
964BA	231	1046K	404	1128BAX	104, 405	1200MS	109	1263/E70	415
964BA/L	231	1047	99	1128BCX	104, 406	1201	109	1263/E78	414
965	173	1047BM	99	1128BMX	104, 406	1201/S	109	1263/E85	414
965/S	173	1048	99	1128BSX	104, 406	1201DZ	109	1263/D...	115
965BA	231	1048BM	99	1128BM	104	1201K	407	1263/S12	115
966/C3	173	1048K	405	1128MQ	222	1201N	109	1264	115
966BA	231	1048MQ	222	1129BM	104	1201NK	407	1264/S	115
966BA/V	232	1048V	99	1129BMK	406	1202	110	1265ES	115
969/C5	173	1048VK	405	1130BMX	105, 406	1202/S	110	1265ES/S	115
969B	173	1050	99	1131CK	105	1202K	407	1264K	408
970B	174	1051	99	1132	105	1202N	110	1264L	115
970C	174	1051GM	99	1132BM	105	1202NK	407	1266BP	115
970EA	173	1051L	99	1132BMK	406	1202L	110	1266BP/S	116
970EB	174	1051XL	99	1132K	406	1203/D	110	1267TX	116
970OT	174	1052	99	1132MQ	222	1203/E1P	414	1267TXK	408
970Q	174	1052K	405	1133	105	1203/E4P	414	1267TX/D	116
971/C8	174	1053	100	1133RL	105	1203/E5P	414	1267TX/S	116
971TSP	174	1054	100	1134	105	1203/E10P	414	1268RTX	116
978 - 979	174	1055	100	1134RL	105	1203/S10	110	1268RTXK	408
982	174	1056	100	1134A	105	1204	110	1268RTX/S	116

ALPHANUMERIC INDEX

1269N/PZ	116	1335BM	177	1428	124	1470	187	1485R/P17	193
1269N/PZK	408	1337/S5	177	1428/SB11	124	1470FT	187	1485VAG	193
1269PZ	116	1338A - 1338B	177	1428L	179	1471	187	1486/10	194
1269PZK	408	1338	177	1428L/B3	179	1471A	187	1486/20	194
1269PZ/S	116	1338R9 - 1338R12	177	1429	124	1471M/C22	187	1486/30	194
1270BA	232	1342	177	1429/SB7	124	1471M/50	187	1486/40	194
1272BA	232	1342PM	177	1430/...	124	1471M/P	187	1486/50	194
1272MQ	223	1342PMR	177	1430/S	124	1471M/W50	187	1486/60	194
1273MQ/D6	223	1343	177	1433	124	1471PN/B1	187	1486/70	194
1273MQ/E1	415	1344	177	1433/C11	124	1471PN/B2	187	1486/80	194
1272MQ/S	223	1345	177	1435	124	1471PN/B3	187	1486/90	194
1274MQ	223	1351	177	1435R	124	1471PN/B4	187	1488/1	194
1274MQ/S	223	1353	177	1435/1	125	1471PN/B5	187	1488 - 1488L	194
1279MQ	223	1357Z/45	178	1435/1R	125	1471CF	187	1488R...	194
1279MQ/S	223	1359T	178	1437/C12	179	1471CM	187	1489/31T	195
1281/B28A	117	1360/K6	178	1438	179	1471CM/E11	188	1489/33	195
1281BG	116	1362	178	1438R	179	1471D2	188	1489/33P	195
1281BG/A9	117	1365/K13	178	1438DSG	179	1472	188	1489/C14	195
1281BG/B28A	117	1365P10	120, 178	1483KV-PT/S7	66	1472AU	188	1489/E	195
1281BG-TX/A8	117	1366A	178	1438 SAC	180	1472AU/P	188	1489R	195
1281LP	116	1366KF	178	1439/K7	180	1472AU/RP	188	1489/Y	195
1281LPH	117	1366/K5	178	1440/...	180	1472FC	188	1490/1 - 1490/2	195
1281PB	116	1367/S6	178	1445/1 - 1445/2	180	1472FC/L	188	1490 /R1 - 1490 /R2	195
1281PE	117	1367	178	1450GC	180	1472FCA	188	1491	195
1281PH	117	1368	179	1452K	180	1472FCL/RP	188	1491C	195
1281PM	116	1368G/CV	179	1452PN/K	180	1472R/AU	188	1491R	195
1281PZ	117	1368G/C2U	179	1455SVP	180	1472TM	188	1492/1 - 1492/2	195
1281RTX	117	1369/C11	179	1455SVP/R...	180	1472VW	188, 409	1492T	195
1281TX	117	1368G/K400	179	1458	180	1473	188	1493	196
1290	117	1368G/OD	179	1460F	180	1473A	189	1493/C19	196
1290/S...	118	1368G/SD	179	1461/C3B	181	1473FN	189	1493/C30	196
1290K	408	1370	120	1461/C5G	181	1473P	189, 409	1493/PF	196
1290N	118	1370/MR...	120	1461/C6B	181	1473Q	189	1493/S-U	197
1290NK	408	1370BA	232	1461/C6G	181	1473T	189	1493AL	196
1292	118	1370BA/MR	232	1461/C7B	181	1474/C4	189	1493AL 4S	196
1292/S	118	1370F	120	1461/C8B	181	1474DL	189	1493AL CF	196
1292K	408	1370T	120	1461/C8G	181	1474E/VW	189	1493B	196
1292L	118	1370F/MR...	121	1461/C9B	181	1474G	189	1493B/S5	196
1292N	118	1370FT	121	1461/C10A	181	1474L	189	1493FF	197
1292NK	408	1374F	121	1461/C10G	182	1475U	189	1493T	197
1293/D...	118	1374F/MR...	121	1461/C11A	182	1476	189	1493J	197
1293/S...	118	1375	121	1461/C11G	182	1476/RC	189	1493Z/1 - 2 - 3	197
1293BP	119	1375/MR	121	1461/C12A	182	1476A	190	1494	197
1293BP/S	119	1375A	121	1461/C12G	182	1476A/RC	190	1494/C14A	197
1293BX/DA	416	1375B	121	1461/C13A	182	1476C/1 - 1476C/2	190	1494E	197
1293BX/DD	416	1375BA/PL	233	1461/C13B	182	1476GT	190	1494M	197
1293BX/DE	416	1376X	121	1461/C16	182	1476PSA	190	1494Q	197
1293BX/DF	416	1376X/MR	121	1461/C17	182	1476T	190	1494T	197
1293ES	119	1376XT	121	1461/C17B	183	1477/C10	190	1494VW	197
1293ES/S	119	1376XT/MR	121	1461/C18B	183	1477D	190	1494XZN	197
1294	119	1377	121	1461/C19	183	1477D/S5	190	1495/C6	198
1294/S	119	1377/MR...	122	1461/C20G	183	1477K/7	190	1495M	198
1294K	409	1377BA	233	1461/C21G	183	1478	190	1495T	198
1294L	119	1377BA/PL	233	1461/C22B	183	1478/3P	190	1496/A	198
1295	119	1378	122	1461/C23B	183	1478T	190	1496/C	198
1295/C14	119	1378/MR...	122	1461/C24B	183	1479	191	1497/C23	198
1297TX	119	1379BA	233	1461/C25G	183	1479/B27	191	1497/C94	198
1297TX/D	120	1379F	122	1461/C26B	184	1479L/S2	191	1497CEL	198
1297TX/S	119	1379F/MR...	122	1461/C27G	184	1479N/S5	191	1497D	198
1298RTX	120	1380	122	1461/C28B	184	1479RB/1	191	1497P	198
1298RTX/S	120	1380/MR...	122	1461/C29B	184	1479RB/2	191	1497RC	199, 409
1298RTXK	409	1380BA	233	1461/C30G	184	1479RB/3	191	1498	199
1299N/PZ	120	1380BA/MR	233	1462/KD	184	1479U/13	191	1498/2A	200
1299N/PZK	409	1380S	122	1462/KI	184	1479U/32	191	1498/4A	200
1299PZ	120	1380S/MR...	122	1462/KMRC	185	1480	191	1498/4A-8A CO	201
1299PZ/S	120	1380T	122	1462/KU	185	1481/C12	191	1498/4A-8A CP	201
1299PZK	409	1381	122	1462AD/BSC	185	1481PL	192	1498/8A	200
1302	175	1381/MR...	122	1462AD/SMN	185	1481PL/S3	192	1498/40A	200
1303	175	1381BA	233	1462CF/C6	184	1482	192	1498/50A	201
1304	175	1381BA/MR	233	1462CF	184	1482A/1	192	1498/12	199
1305	176	1381T	123	1462PIM	185	1482A/2	192	1498/24	200
1305Z	176	1385	123	1463/KIT	185	1482A/3	192	1498B12/R02	200
1306	176	1385/MR	123	1464AP	185	1482A/4	192	1498C/24	200
1307	176	1390	123	1464APB	185	1482A/5	192	1498CM/12	199
1308	176	1390/MR...	123	1464IC	185	1482/8 - 1482/10	192	1498LT/12	199
1309	176	1390BA	233	1464PF	186	1482B	192	1498LT/12-SF	199
1310	176	1390BA/R	233	1464PT	186	1482C	192	1498PC	201
1312	176	1390N	123	1464T	185	1483/K12	193	1498MN/12	199
1313	176	1390NR	123	1464TDI	186	1483KV-PT/S7	193	1498MN/12-C	199
1314	176	1390R	123	1466/C5	186	1483K/22	193	1498SM	201
1326	176	1391	123	1467	186	1484	193	1498ST/TB	201
1327	176	1391A	123	1467/RK1	186	1485/KIT	193	1498ST/TB ROT	201
1328	176	1392	123	1467/RK2	186	1485BP	193	1498TB/12	201
1329	176	1392R	123	1467LF	186	1485MJ	193	1498TC	202
1330	176	1393	124	1467LF/RC	186	1485R	193	1499	202
1331	177	1410/M	124	1468N	186	1485R/P10	193	1500/...	125

ALPHANUMERIC INDEX

1500/SP	125	1599G	130	1687/S4	138	1719BMA...P	143	1752	149
1500G/...	125	1599P	130	1687A	138	1719BMA...Q	143	1752R	149
1500N/...	125	1599T	130	1687AC	138	1719BMA...R	144	1753	149
1500N/G...	125	1601/PC	130	1687D	138	1719BMA...S5	144	1753R	149
1500N/SP	125	1602	130	1687U	138	1719BMA...T	143	1754	150
1501/1 - 2 - 3	125	1602/C9T	130	1688	138	1719BM/RL	144	1755	150
1501G/1 - 2 - 3	126	1602A	130	1688A	138	1719BM/RR	144	1756	150
1501Z/S - P - R	126	1602BA	233	1688M	138	1719BMB/P	144	1756B	150
1505/C5	202	1603	130	1688PC	138	1719BMC	144	1756C	150, 206
1505V	202	1603A	130	1688PC/R	138	1719BMD...M	143	1756C-2OR	150, 206
1506	126	1603B	130	1690F	138	1719BMD...P	143	1756D-2OR	206
1508/1 - 1508/2	126	1603BK	409	1690L	138	1719BMD...Q	143	1756D	206
1511/1 - 2 - 3	126	1603K	409	1691BM	138, 409	1719BMD...R	144	1757	206
1515/1 - 2 - 3	126	1604	131	1692	138, 409	1719BMD...S5	144	1757A	206
1516/1 - 2 - 3	126	1604/C9T	131	1694/L	139	1719BMD...T	143	1758A	206
1517	126	1605	131	1694A/L	139	1719BMR	144	1758LG	206
1518/...	127	1606	131	1694B/L	139	1719BMX...M	144	1758M	206
1520/1 - 1520/2	127	1606A	131	1695XS	139	1719BMX...P	143	1758R	207
1521/1 - 1521/2	127	1606A/C9	131	1696	139	1719BMX...Q	143	1758VT	207
1529	202	1607	131	1696A	139	1719BMX...R	144	1758VT/L	207
1529PI	202	1608	131	1696B	139	1719BMX...S5	144	1759	207
1530/C5	202	1608/C9T	131	1696D	139	1719BMX...T	143	1759A	207
1532	127	1608A	132	1696S	139	1719R/...	144	1759B	207
1533/...	127	1609	132	1699L	139	1720/...	144	1759HD/3	207
1533PR/1 - 2 - 3	127	1609A	132	1699L/1	139	1720/B	145	1759HD/RR	207
1534/...	127	1609B	132	1699Q	140	1720/S	144	1759HD/TRUCK	207
1535/C...	127	1609C/C5	132	1700N	140	1720D/...	145	1759TT	208
1539	127	1609M	132	1700N/PM	140	1720D/B	145	1760/IR800	152, 209
1540	127	1610	132	1701BA	233	1721/B6	145	1760/IR1600	152
1542/1 - 1542/2	128	1614	132	1701N	140	1723	145	1760/OHM	151, 208
1544/...	128	1616	132	1701N/PM	140	1725	145	1760/RMS	151
1545/C5M	128	1618	132	1701PMR	140	1725CR	145	1760/TC2	152, 209
1547/C6	128, 202	1620	132	1701NE/...	140	1725MQ	223	1760B	151, 208
1547KP	128, 202	1622	133	1702N	140	1726	145	1756D	150
1547P	128, 202	1624	133	1702N/PM	140	1726BM	145	1756D-2OR	150
1547PC/2	128, 203	1628	133	1702PMR	140	1727	145	1760DGT	150, 208
1547PL/2	128, 203	1630	133	1703BA/A	233	1727BA	234	1760PA/AC	151
1548/C8	203	1632	133	1703BA/P	234	1727BM	145	1760PA/AC-DC	151, 208
1549	203	1634	133	1703BA/PL	234	1728...	145	1760PA/80	151, 208
1550U	203	1639NS-N	133	1704	140	1728BA	234	1760K	152, 410
1550U/M	203	1639S	133	1704A	140	1729	145	1760PT	152
1550U/MRC-ABE	203	1640	133	1704C	140	1729CG	145, 409	1760R/TC2	152, 209
1550U/MRC-C	203	1640A	133	1705	140	1729DM 450	145, 409	1761	152
1550U/S...	203	1640K	133	1705PT	141	1729LR	145	1761RS/1	152
1550U/SS187	203	1640P	134	1706DGT	141	1736A	146	1762	153
1555C	204	1640Q	134	1707	141	1737	146	1762K	410
1555Q	204	1640T	134	1707A/1 - 2 - 3	141	1737AC	146	1763	209
1555/QS	204	1650	134	1708/8 - 13 - 20	141	1737B	146	1763G/S500	209
1555S/BMW-RNT	204	1650FD	134	1709/10 - 1709/18	141	1737BA	234	1765/C24	209
1556/1A	204	1650FT	134	1710	141	1737NX	146	1766	153, 209
1556/2A	204	1651DGT	134	1712E/1 - 2 - 3	141	1738	146	1766A	153, 209
1557	204	1651DGT/IP	134	1712E/L1	141	1739B	146	1766G	210
1557/S3	204	1652	134	1712E/R-L1	141	1740A	146	1766ER	210
1557V	204	1654	134	1712TF	141	1740B	146	1766I	210
1558/C4	204	1654DGT	134	1713M	141	1741B	146, 410	1766L	210
1558P	204	1656	134	1714	141	1741B/C5	146	1766LI	210
1559	204	1657DGT/2	135	1715	141	1741BP	146	1766T	210
1559V/8T	205	1658/...	135	1715B/R5L	142	1741U	147, 409	1766/8	209
1560/1 - 1560/2	205	1658/C4	135	1715FL/A	141	1741RV...K	147	1767A	210
1560A	205	1658DGT	135	1715FL/B	142	1742	147	1767PMC	153, 210
1561/...	205	1658SP/1	135	1715R/FL	141	1742KR	147	1767PMR	153, 210
1562D	205	1659	135	1716A	142	1742R-A/M...	147	1770	153
1565/1 - 2 - 3	205	1662/1 - 1662/2	135	1716P	142	1742R-AL/M...	147	1770A	153
1566/GO1	205	1662AN	135	1716Q	142	1742/C4	147	1770BM	153
1566N	205	1662DGT/A	135	1716R	142	1742A	147	1770RL	153
1566P	205	1662SP0	135	1716U	142	1742A/C	148	1771	153, 410
1567	205	1662SP2	136	1717A	142	1742A/KR	147	1771BM	153, 410
1568/C15	205	1666	136	1717B	142	1743	148	1771RL	153
1568R/CS3	205	1666A	136	1717BA	234	1743T	148	1772H	153
1569/A	205	1668	136	1717BA/1	234	1748/...K	148	1772R	153, 410
1569/B	206	1668A	136	1719BA8	234	1748B/...K	148	1772RL/2	154
1569/F	206	1670	136	1719BA12	234	1749	148	1773A	154, 410
1569CP	206	1670A	136	1717C	142	1749A	148	1773RL	154
1570/3	128	1672	136	1717D	142	1749A/RB	148	1774	154
1580/8I	128	1672A	136	1718A...M	142	1749A/RT	148	1774A	154
1580GL	129	1674A	137	1718A...P	142	1749AC	148	1774A/RL	154
1585/5I - 6I - 7I	129	1676	137	1718A...Q	142	1750	148	1776BA	234
1585GII/5 - 6 - 7	129	1678/C3	137	1718A...R	143	1750R/1 - 1750R/2	148	1777BM	154
1589VI	129	1679	137	1718A...S5	143	1750RC	149	1777BMT	154, 410
1589PI/50 - 100 - 150	129	1679 /PR	137	1718A...T	142	1750RP/1 - 1750RP/2	149	1777MQ/C	223
1590	129	1680	137	1718D...M	142	1750CG	149	1777MQ/U	223
1591	129	1680A	137	1718D...P	142	1750RT	149	1777RL/U	223
1593	129	1680B	137	1718D...Q	142	1750KG10	149	1777T	154, 410
1594	129	1680C	137	1718D...R	143	1750M	149	1778CM	154
1595	129	1682	137	1718D...S5	143	1750TA	149	1778D	154
1599B	130	1683	137	1718D...T	142	1751	149	1778SAFE	154
1599F	129	1685/C7	138	1719BMA...M	143	1751R	149	1778SCL	154

ALPHANUMERIC INDEX

1778SOS	154	1870-72/FL	163	1933I	241	2080/V6-U	254	5904VG/3	365
1778V18	155	1872L	162	1933L	241	2080/V12	254	5904VG/3T	366
1778W	155	1872L 35/FC	163	1933IL	241	2080 /V12-S	254	5904VG/5T	367
1778X	155	1872L 35/5S	163	1934BV	241	2115P L-MQ32	213, 222	5902VI	323
1781	155	1873	163	1934MAV	241	2250-O	164, 212	5904VI/1T	324
1783	155, 410	1873 30/5S	163	1934MAV70	241	2251-O	164, 212	5904VI/2T	325
1784	155	1874	163	1935F	242	2252	165, 212	5904VI/3T	326
1784BA	234	1874 50/FC	164	1936/4A	242	2252KR4	165, 212	5904VU/1M	335
1800/100	155	1874 50/5S	163	1936/5A	242	2254T	165, 212	5904VU/2M	336
1808	155	1877	211	1936/5	242	2258-O	165, 213	5904VU/2T	337
1812 150	155	1877A	211	1936/7	242	2300ST/KIT	261	5904VU/3T	338
1814M	155	1878 3	211	1937	242	2400S/PF	271	5905VG/1	368
1820	155, 410	1878 11	211	1937C	243	2499PC	271	5905VG/2	369
1820 60	155, 410	1878 30	211	1937K..	243	2499PF	271	5908VG/2T	370
1820 80	155, 410	1879	164, 211	1937KC	243	2499PF/M	271	5908VI/2T	327
1822	155, 410	1879R/K4	164, 211	1937KL	243	2499S-R/PC	271	5910VG/3T	371
1822 180	155, 410	1880	164, 211	1937KL-D	243	3000M/LT	213	5910VI/3	328
1822 320	155, 410	1881	164, 211	1937M	244	3000M/RLS	213	5910VI/3T	329
1823 60	156	1882	164, 211	1937M-01÷11	244	3000S/PLM	276	5914VU/M	339
1823R/60	156	1883	164, 212	1937N10	244	3002	214	5915VU/0	340
1824R	156	1883NC	164, 212	1937N10-GR	244	3002/RLS	214	5915VU/1	341
1825B	156	1884	212	1937N20	244	3003	214	5915VU/2	342
1827	156	1884/C12	212	1937N20-GR	244	3003/RLS	214	5915VU/3	343
1827/K	156	1889	164, 212	1937R/P	242	3007	214	5915VU/4	344
1827PC	156	1895 6	164, 212	1937RT	243	3008	214	5915VU/5	345
1827PCL	156	1901BM/8	248	1937RT/R	243	3009	214	5915VU/AS	346
1827PFL	156	1901T/10	248	1937RT/T	243	3009R/GR4	214	5927VU/M	347
1830T	156	1910/8 - 1910/10	248	1938	244	3010/T..	214	5935ET/1MB	353
1834L/USB	156	1914	248	1938R/L	244	3011/T	215	5935VG/1MB	372
1834PL	157, 410	1915B	249	1938R/S5	244	3012	215	5935VI/1MB	330
1834PM	157, 410	1915C	249	1940	245	3012C	215	5935VI/2MB	331
1834PS	156, 410	1915C/L	249	1940/S5	245	3012I	215	5935VU/1MB	348
1834PXL	157, 411	1915D	249	1940E10	245	3014	215	5938U/2T	349
1834RB-L/USB	156	1915E	249	1940E10/MT	245	3014R/GR5	215	5940SBK	373
1834RR	157, 411	1915E/XL	249	1940E10/S...	245	3014SAR	215	5953VG	374
1835/1	157	1916G	249	1940E10/S5	245	3014SAR/RR	215	5953VI	332
1835/2	157	1916I	249	1940MT	245	3014SAR/1	215	5954VG	375
1836A	157, 411	1917F	249	1940S...	245	3014SAR/2	215	5954VI	333
1836B	157, 411	1917M	249	1942A	245	3025	215	5957U-P	350
1837/USB	158	1917RS	249	1942LR	245	3025/PF	216	5957VG	376
1837N	157, 411	1919F1/4	250	1944	245	3025/RF	215	5957VI	334
1837PLUS	158	1919FE1/4	249	1944AR	246	3025/RG	216	5958U	351
1837RB/USB	158	1919ML	250	1946	246	3026 0,3	216	5980/MQ	356
1838/11LED	158	1919RB-FE1/4	250	1946C4,8	246	3026 0,5	216	5980EL/A	357
1838COB	158, 411	1919RF-FE1/4	250	1946C7,8	246	3026 1,0	216	5980EL/B	358
1838FLASH	159	1919RM-FE1/4	250	1946KF	246	3026/R0,3	216	5980ET/A	354
1838P	158, 411	1919F3/8	250	1946KF/M...	246	3026/R0,5	216	5980ET/B	355
1838LED/120	159	1919F1/2	250	1947	246	3026/S	216	5980ID	359
1838LED/120-AL	159	1919RB-F	250	1947G	247	3026/SP	216	5988U6/M	352
1838RA/10-11LED	158	1919RF-F	250	1947H	246	3027/KP	165, 217	6200AP/S10	461
1838RB/10LED	158	1919RM-F	250	1948	247	3027/KPP50	165, 217	6600 E/A10	423
1838RB/FLASH	159	1919SC	250	1948PR	247	3027 10	165, 216	6600 E/A20	423
1838RR/11LED	158	1919L	250	1949BC	247	3027 20	165, 216	6600 E/A30	423
1838RV/11LED	158	1921B1	236	1949BC/RU	247	3027 30	165, 217	6600 E/B10	424
1838SN	159, 411	1921I	236	1949G	247	3030/2T	217	6600 E/B20	424
1838SL	159	1921M1	236	1949DGT	213, 248	3030/2T-R5	217	6600 E/C10	424
1838SLR	159, 411	1921M2	236	1949F	247	3030/2T-R6	217	6600 E/K20	424
1838UV	159	1921N3	236	1949GPE	213, 248	3030/2TRP	217	6600 M/11	417
1839/R1	159	1924B	236	1949GPN	213, 248	3033/3T	217	6600 M/22	418
1839/R2	159	1924CD	236	1949M	213, 248	3035	217	6600 M/27	418
1839/R3	159	1927A	237	1949T	247	3040	218	6600 M/38	418
1840BM	159	1927AN	237	1951	248	3040A/1	218	6600 M/39	418
1842LED/ABM	160	1927CD	237	1995MQ/G1 - G2	223	3040A/2	218	6600 M/40	418
1842LED/BM	160	1927P	237	1995MQ/T	223	3040A/6-8-10	218	6600 M/47	418
1843BM	160	1927SP-AM	237	2001/B26	252	3041	218	6600 M/51	418
1843R/BM	160	1927XM	237	2001/BV	252	3041A/11	218	6600 M/52	418
1846LED/ABM	160	1928CD	238	2005PA/D	252	3041A/15	218	6600 M/58	418
1846LED/BM	160	1928DA	238	2005PA/S	252	3041T	218	6600 M/61	418
1846R-LED/BM	160	1928DAL	238	2029E	252	3041T/17	218	6600 M/63	418
1848	160	1928K4	238	2009ID	252	3042	218	6600 M/73	418
1850B	160	1930A	239	2009N/BV	252	3042/K6P	218	6600 M/112	419
1850C	160	1930CD	238	2029/RT	252	3043	218	6600 M/116	419
1850U...	161	1930HLA	239	2029/VV	252	3043A/41÷47	218	6600 M/120	419
1851VK	161	1930LA	239	2032/TE	253	3061/2T	219	6600 M/125	419
1851VK-12C	161	1930PA	239	2032/TV	252	3061 /2T-P50	219	6600 M/126	419
1851VK-12V	161	1930NCD	238	2032/VV	252	3061 /2T-P100	219	6600 M/131	419
1852R1750	161	1930ZL	239	2032E	252	3063/2,5T	219	6600 M/173	419
1852S-F	161	1927SP-AM	213	2033E	253	3065/40-20T	219	6600 M/216	419
1852S-FLESS	161	1931AN10	240	2033P/VV	253	3067/70-13T	219	6600 M/221	419
1852S-L	161	1931CD6	239	2036/TV	253	3500/P	282	6600 M/230	419
1852S-PIATTE	161	1931CD10	240	2036E	253	3500/D	282	6600 M/234	419
1860 140A	162	1931CD13	240	2037/TV	253	5700LAMP	299	6600 M/241	419
1860 160A	162	1932B10	240	2041UC	253	5902MT	360	6600 M/244	420
1860RC	162	1932B13	240	2051N	254	5902MT/AS	361	6600 M/311	420
1870	162	1932RS13	240	2055HB	254	5904VG/1M	362	6600 M/315	420
1870-20/5S	163	1933AN90	241	2060/VV	254	5904VG/2M	363	6600 M/320	420
1870-72 /FC	163	1933	241	2080/V6	254	5904VG/2T	364	6600 M/326	420

ALPHANUMERIC INDEX

6600 M/327	420	7294TKK	445	7900E	455	8043	472	8205	485
6600 M/330	420	7300FT	443	7901E	455	8043-K	493	8206	485
6600 M/370	420	7300MK	443	7903E	455	8044	471	8207	485
6600 M/378	420	7310BKK	434	7904E	456	8048	472	8209	485
6600 M/417	420	7313B	437	7905E	455	8049	472	8210	486
6600 M/418	420	7313G	437	7907E	456	8050D	476	8216	486
6600 M/427	420	7316N	438	7909E	456	8051S	475	8216-K	493
6600 M/430	421	7319ESD	443	7930P	457	8051S-K	493	8220	486
6600 M/440	421	7323M	438	7931P	458	8052	475	8225	486
6600 M/456	421	7328EA	428	7933P	458	8057	475	8227	486
6600 M/464	421	7328EN	429	7935P	458	8057R	475	8228	486
6600 M/480	421	7330NV	445	7939P	458	8058	475	8240	486
6600 M/485	421	7340B	440	7970	458	8058R	475	8242	487
6600 M/510	421	7340Y	441	7971E	459	8060	475	8240F	487
6600 M/528	421	7340R	441	7973	459	8060R	475	8242F	487
6600 M/532	421	7341N	441	7978E	459	8061F	475	8248	487
6600 M/542	421	7349RP	441	7979	459	8061R	475	8249	487
6600 M/561	421	7350RP	442	7981T	460	8062	476	8249G	487
6600 M/583	421	7360UN	438	7984	460	8063	476	8250	487
6600 M/609	422	7361UB	439	7985	460	8064S	476	8264	488
6600 M/637	422	7361UM	439	7991N	459	8065SC	476	8267	488
6600 M/650	422	7368UG	439	7992N	459	8074	472	8272	488
6600 M/657	422	7368UM	439	8001Z	464	8080	472	8273	488
6600 M/658	422	7368UN	440	8001Z-K	491	8082	472	8274	488
6600 M/715	422	7369UB	440	8001TZ	464	8083	472	8274A	488
6600 M/814	422	7398AL	446	8001TZ-K	491	8085	477	8274G	489
6600 M/840	422	7398BF	446	8002ZD	464	8086	477	8276	489
6600 M/841	422	7398EF	446	8002ZS	464	8090	477	8276G	489
6800 VE	417	7398GEL	446	8004ND	464	8090F	477	8278	489
6888	417	7398U	446	8004NS	464	8091	478	8280	489
7042LCD	162	7399A/N...	447	8003ZD	465	8092	478	8282	489
7042LCD/RV	162	7410	447	8003ZS	465	8094	478	8284	490
7042LCD/RV-INT	162	7413	447	8005Z	465	8096	479	8285	490
7051MP	460	7415	447	8005Z^	491	8097	479	8286	490
7061TC	460	7416	447	8005TZ	465	8098	479	8287	490
7076BC	460	7417	447	8005TZ-K	491	8100	477	8290	490
7076BD	460	7418	447	8006Z	465	8105	466	8293	490
7076BP	460	7525	449	8006Z-K	491	8105-K	491	8297C	490
7076BU	460	7526	449	8007Z	465	8109	466	8297F	490
7093BC	460	7546BL	450	8007Z-K	491	8109-K	492	8302Z	474
7093BD	461	7546G	450	8008N	466	8114	473	8303Z	474
7190C	460	7546N	450	8008N-K	491	8116	473	8317DZ	468
7195A	460	7548BL	450	8009FD	465	8120	473	8317SZ	468
7200BKK	431	7548G	450	8009FS	465	8130	473	8381SL	474
7200PN	432	7548N	450	8009Z	466	8130A	473	8381SP	474
7201BKK	432	7622G	451	8009Z-K	491	8131DL	473	8381SX	490
7201PN	432	7632G	451	8009TZ	466	8131Z	473	8383C	474
7208WR	432	7635N	451	8009TZ-K	491	8139DL	473	8383P	474
7210BKK	433	7635G	451	8010Z	466	8139Z	473	8515V	474
7210PB	433	7636BL	451	8010Z-K	491	8139ZCH	474	8515Z	474
7211PG	433	7577N	451	8016	467	8150	480	8531	469
7212FG	430	7578G	452	8016U-K	492	8153	480	8532	469
7213FG	430	7683	452	8016FR-K	492	8156	480	8535	474
7214FN	431	7684	452	8016-K	492	8157	480	8600 E/R	423
7215FN	431	7685	452	8016DA	467	8158	480	8600 R/10	422
7216BKK	433	7685BL	452	8016DF	467	8159	481	8600 R/112	423
7216SN	434	7734	452	8016FR	467	8160	481	8600 R/224	423
7220PE	429	7780N	452	8016U	467	8161	481	8600 R/411	423
7221PE	429	7800G	460	8018E	467	8166	482	8600 R/514	423
7224PE	430	7815N	449	8018T	467	8170	481	8889I1	398
7235B	434	7816BL	449	8020	468	8173	481	8889I2	398
7236B	435	7816G	449	8021	468	8176	481	8889I3	398
7237WR	435	7820	457	8025	468	8177	482	8889I4	398
7238WR	435	7821	457	8025-K	492	8178	482	8889I6	398
7241B	426	7823	457	8026A	468	8179A	482	8889ID	398
7241C	426	7825	457	8026A-K	492	8179B	482	8889IS	398
7241FT	426	7829	457	8026R	469	8179M	482	8889P1	397
7243B	427	7830ST (ex 7816ST)	456	8026R-K	492	8180	483	8889P2	398
7243C	427	7831ST	456	8028	469	8181	483	8889P3	398
7243CR	427	7833ST	456	8028-K	492	8181S	483	8889P4	398
7243FT	427	7835ST	456	8029	469	8182	483	8889PD	398
7245B	428	7840BL	453	8029R	469	8182A	483	8889PS	398
7246B	428	7849BL	453	8029R-K	492	8182E	483	9504	495
7247B	428	7860E	453	8031R - 8031	470	8182S	483	9505	495
7248G	435	7861E	453	8031R-K	492	8185	484	9507D	495
7249G	436	7863E	453	8032-K	492	8186	484	9507U	495
7250NKK	436	7865E	453	8040EN	470	8187	484	9508K	495
7251NKK	436	7867E	454	8040EN-K	492	8188F	484	9510	495
7252NKK	437	7869E	454	8040EZ	470	8188C	484	9521	498
7253NKK	437	7870E	454	8040EZ-K	493	8188CG/25	484	9521W	498
7290NA	442	7871E	454	8041	471	8188FG3	485	9524SC	500
7291NA	442	7873E	454	8041-K	493	8188VFG2	485	9525/B	498
7293NB	444	7875E	454	8042EN	471	8188VF/35	484	9525/N	498
7293NKK	444	7877E	455	8042EN-K	493	8189	485	9525C	498
7294NB	444	7879E	455	8042EZ	471	8189PA	485	9525R	498
7294NKK	445	7880SC	450	8042EZ-K	493	8201T	485	9526P	502

ALPHANUMERIC INDEX

9527 6T	502	CP15L	257	C55PRO B/2	308	M130	384	T102	391
9527MUG	502	C16 - 2116	257	C55PRO B/2,8	309	M131	384	T103	391
9533N	495	CP17 - CP17L - 2117	257	C55PS	315	M132	384	T105	391
9534B	496	C18 - 2118	257	C55/2PM	315	M135	384	T106	391
9534W	495	C19-2119-C19L-2119L	257	C55/2PF	315	M145	384	T110	391
9537N	496	C20 - C20L - 2120	258	C55PP	316	M153	384	T112	391
9539C/B	498	C22B	258	C55/1PF	316	M160	384	T113	391
9541BIKE	497	C22P	258	C55/3PM	316	M170	384	T120	391
9541F	497	C22S - 2200S	259	C55/3PF	316	M172	384	T131	391
9542A	499	C22W	258	C55LMP/1	320	M174	384	T132	391
9542AL	499	C23S - 2300S	259	C55LMP/2	320	M180	384	T135	392
9542C	499	C23SC - 2300SC	260	C55RB	319	M199	385	T136	392
9542G	499	C23ST - 2300ST	260	C55STR	320	M202	385	T140	392
9542M	499	CD23S	261	C56	301	M204	385	T142	392
9542S	499	C24S/5 - 2400S	262	C56M	301	M208	385	T145	392
9543S	500	C24S/6 - 2400S6	263	C56W	301	M210	385	T146	392
9543W	500	C24S/7 - 2400S	264	C57S A - 5700SA	297	M211	385	T151	392
9544	497	C24S/8 - 2400S	265	C57S B - 5700SB	298	M212	385	T153	392
9545	497	C24SA/6 - 2400SA6	266	C57S C	298	M215	385	T154	392
9547	502	C24SA/7 - 2400SA7	267	C57S D	297	M220	385	T155	392
9547T	500	C24SA/8 - 2400SA8	268	C57SP - 5700SP	299	M226	385	T160	392
9547WSK	500	C24SA-XL/7 - 2400SAXL7	269	C58M	302	M227	385	T161	392
9549PB	501	C24SA-XL/8 - 2400SAXL8	270	C58M/PA	302	M230	386	T164	393
9549USB	501	C24SL - 2400SL	272	C58P - 5800P	300	M234	386	T167	393
9557J 2.0	497	C24 SL-CAB	273	C59A - 5900A	302	M236	386	T168	393
9557J 3.0	497	C25 - 2500	272	C59B - 5900B	303	M237	386	T170	393
9557N	497	C27S	274	C59C - 5900C	303	M240	386	T171	393
9557SB	497	C28 - 2800	275	C62EV/CP	461	M264	386	T172	393
9559/30MT	501	C30S - 3000S	276	C62M/W	461	M285	386	T173	393
9559	501	C33/6	277	C63 G/C	461	M288	386	T175	393
9561V	501	C33/7	278	C63 E/W	461	M289	386	T176	393
9563P	501	C33/8	279	C68	416	M295	387	T177	393
9564B	496	C35/6G	280	C68 G	416	M300	387	T180	393
9564G	496	C35/7G	280	C88 R/1	417	M310	387	T183	394
9564X	496	C35/8G	281	C88SE	417	PV	300	T198	394
9569P	503	C35/9G	281	C88VE	417	SB	398	T199	394
9569S	503	C38 - 3800	282	CB/2	399	S42/17	399	T201	394
9572MB	495	C38L	283	GM	398	S55/8	398	T202	394
9574B	497	C38LA	283	KIT/GPS	398	S55/12	399	T204	394
9574O	497	C38C	284	MB	398	S96T/8	399	T205	394
9575	501	C38T	283	MC10	377	S951/6	399	T206	394
9577M	501	C39/6 - 3900	285	MC20	377	S952/10	399	T207	394
9579C	501	C39/7 - 3900	286	MB11	378	S1719BM	399	T208	394
9580S	496	C39/8 - 3900	287	MB34	378	SGN	399	T209	394
9581	502	C39MD	290	MB35	378	SPG11 - S1203/8	399	T210	395
9582LE	501	C39SM	289	MB36	378	ST2P	399	T212	395
9582LI	501	C39T	288	MB44	379	T10	387	T215	395
9586K	502	C41H - 4100H	291	MB45	379	T15	387	T220	395
9587 9x14	503	C41S - 4100S	291	MB46	379	T16	387	T226	395
9587 13x21	503	C42H	292	MB47	379	T18	387	T227	395
9588/10PI	503	C42S	292	MB55	379	T19	388	T228	395
9588S/10...	503	C41H/CE	293	MB56	379	T22	388	T231	395
9588M	502	C41MS	293	MB57	379	T23	388	T233	395
9589A/36	503	C42 MCH	293	MB61	380	T31	388	T234	395
9589B/36	503	C51	294	MB62	380	T33	388	T236	395
9590B	501	CP51	294	MB63	380	T34	388	T239	395
9592B/C50	502	C53 - 5300	295	M10	380	T40	388	T241	396
9592B/P	502	C54 - 5400	296	M15	381	T41	388	T250	396
9593CA	496	C55	306	M16	381	T45	388	T256	396
9593CV	496	C55A1	318	M30	381	T46	388	T259	396
9593B	496	C55A1/R42	318	M33	381	T48	388	T264	396
9594	502	C55A2	319	M38	381	T50	388	T270	396
9595C	502	C55A2/R70	319	M40	381	T52	389	T273	396
9595 C25	503	C55AB	307	M45	381	T53	389	T281	396
9595T	502	C55AN	317	M46	381	T55	389	T285	396
9596	502	C55AN-PC	317	M50	381	T56	389	T288	397
9597P	500	C55B/2	308	M52	381	T57	389	T289	397
9598A	498	C55B/2,8	309	M53	381	T59	389	T291	397
9598B	498	C55PB/3	307	M55	382	T63	389	T297	397
9599CB	498	C55B PT/2	309	M60	382	T64	389	TSPP	399
9599CB-W	498	C55B PT/2,8	310	M63	382	T65	389	VE1	398
C04TSS-7	261	C55B/GD	310	M65	382	T68	389	VP1 - VP2	397
C4 - 2104	254	C55B/GS	310	M69	382	T73	389	VP3 - VP4	397
C5 - 2105	255	C55B/GDE	310	M75	382	T75	390	VP5	397
C6T - 2106	255	C55B/GSE	311	M79	382	T76	390	VP6	397
C7 - 2107	255	C55B/GSAA	311	M82	382	T77	390	VP-3SC	397
C8 - 2108	255	C55B/GSAA	311	M83	382	T79	390	VP-LD	397
C9 - 2109	255	C55B/GSAA	311	M85	382	T80	390	VP-LS	397
C9/RT	255	C55B/GDS	311	M86	383	T81	390	VPM0	387
C10 - 2110	255	C55C7	312	M91	383	T82	390	VPM3	387
C10S - 2110S	256	C55C8	312	M92	383	T83	390		
C11	256	C55M7	313	M100	383	T85	390		
C12 - 2112	256	C55MS	313	M110	383	T91	390		
C13	256	C55MA	314	M112	383	T92	390		
C14	256	C55M2	314	M120	383	T100	391		
CP15	256			M121	383	T101	391		

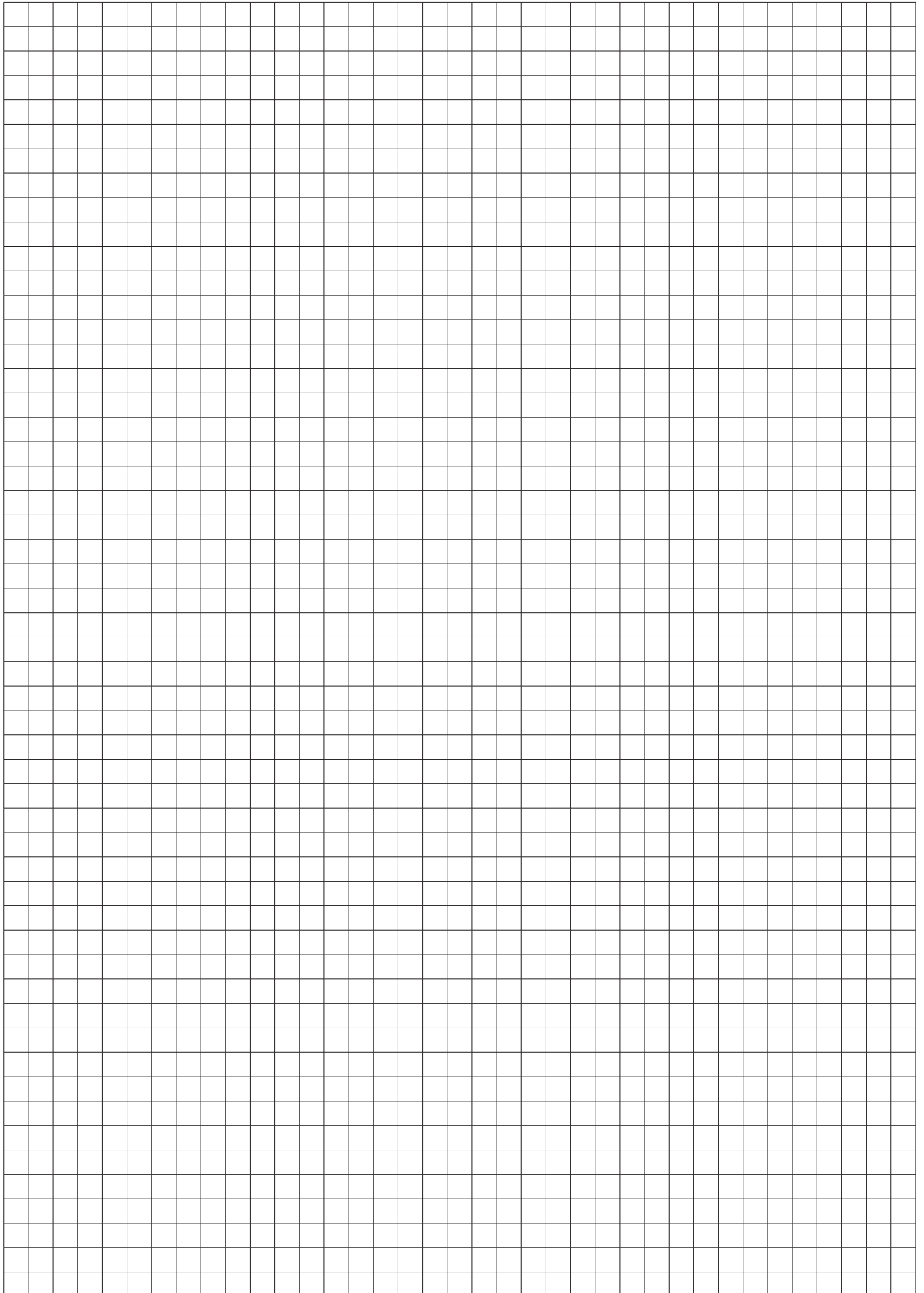

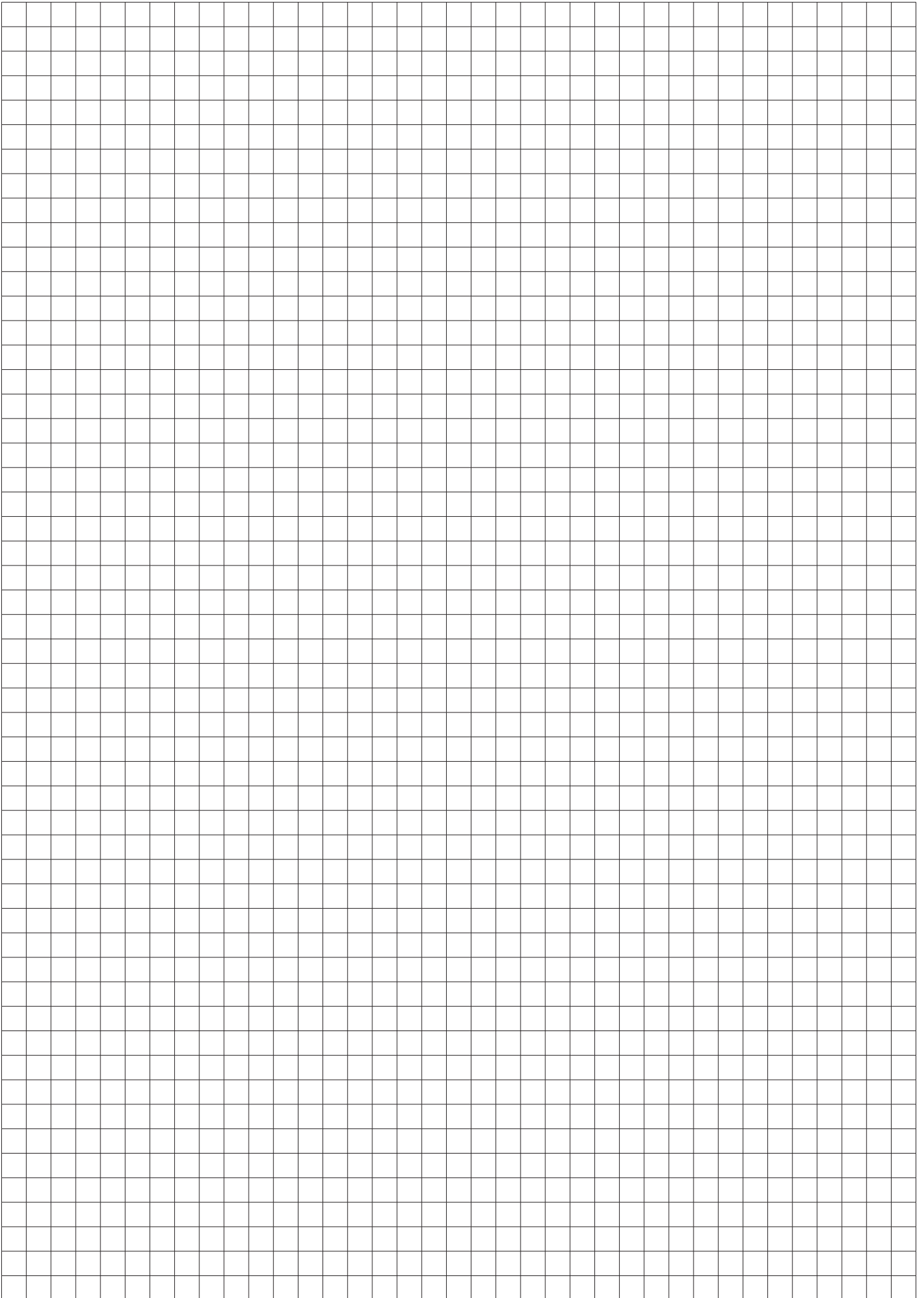

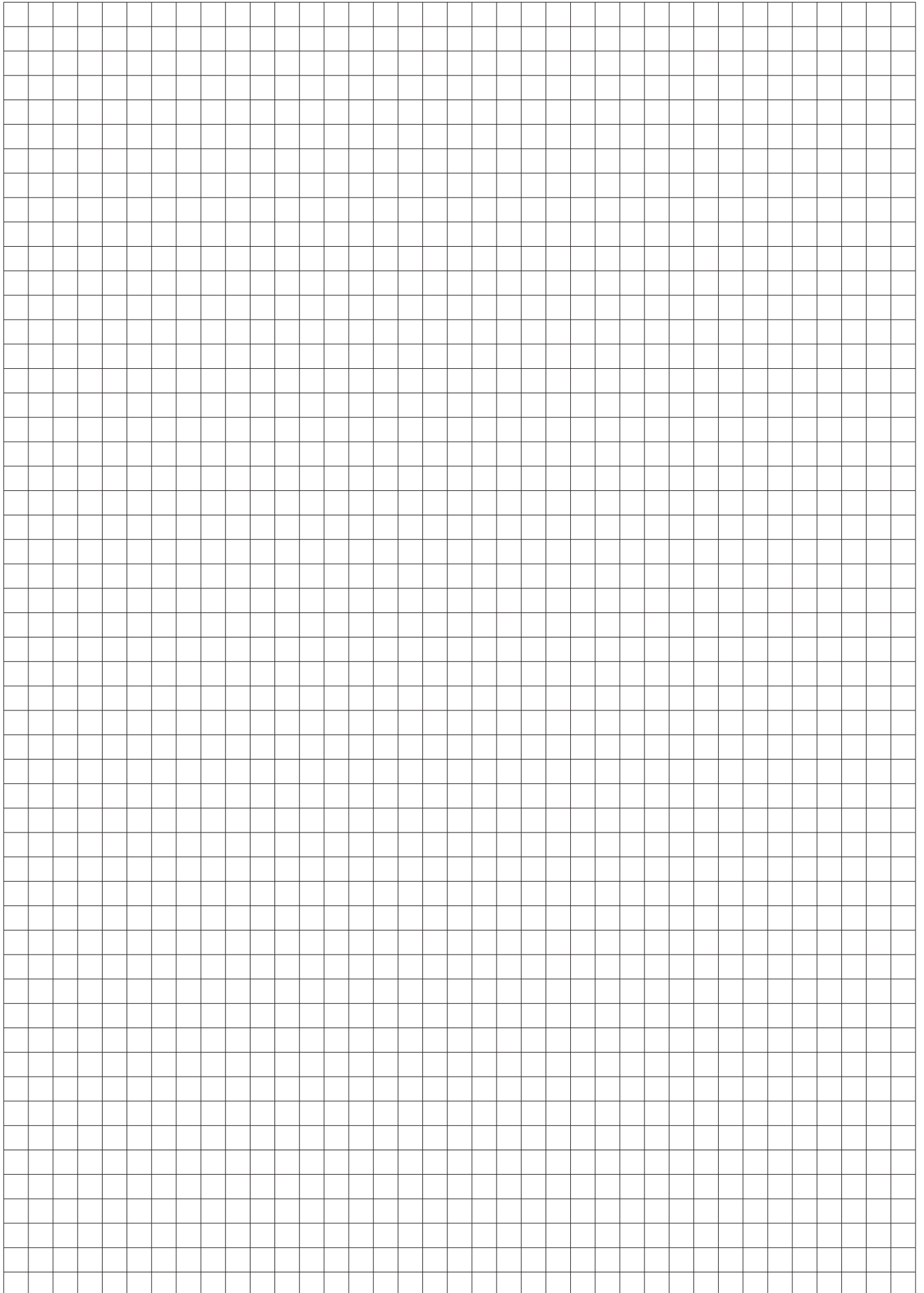

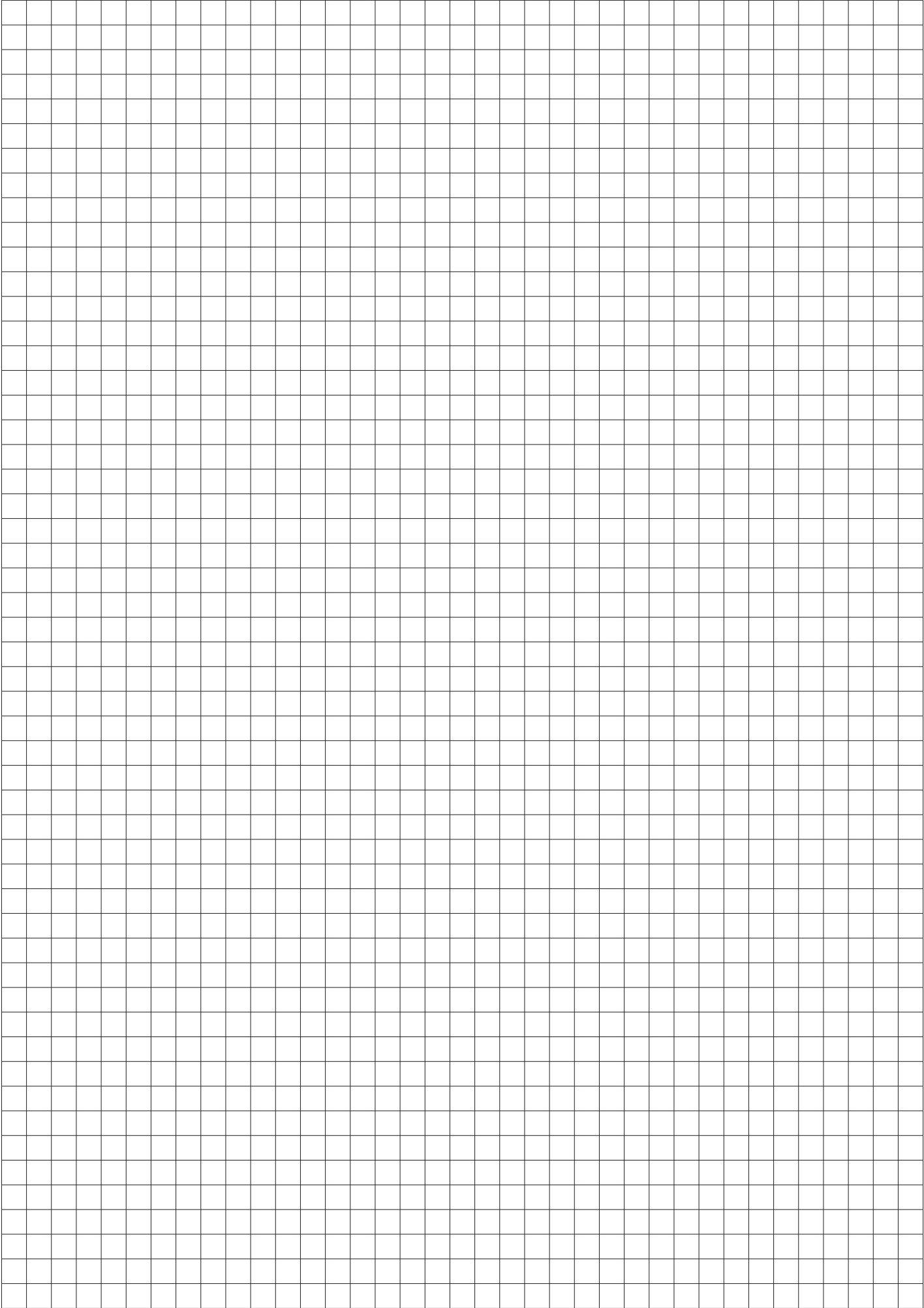

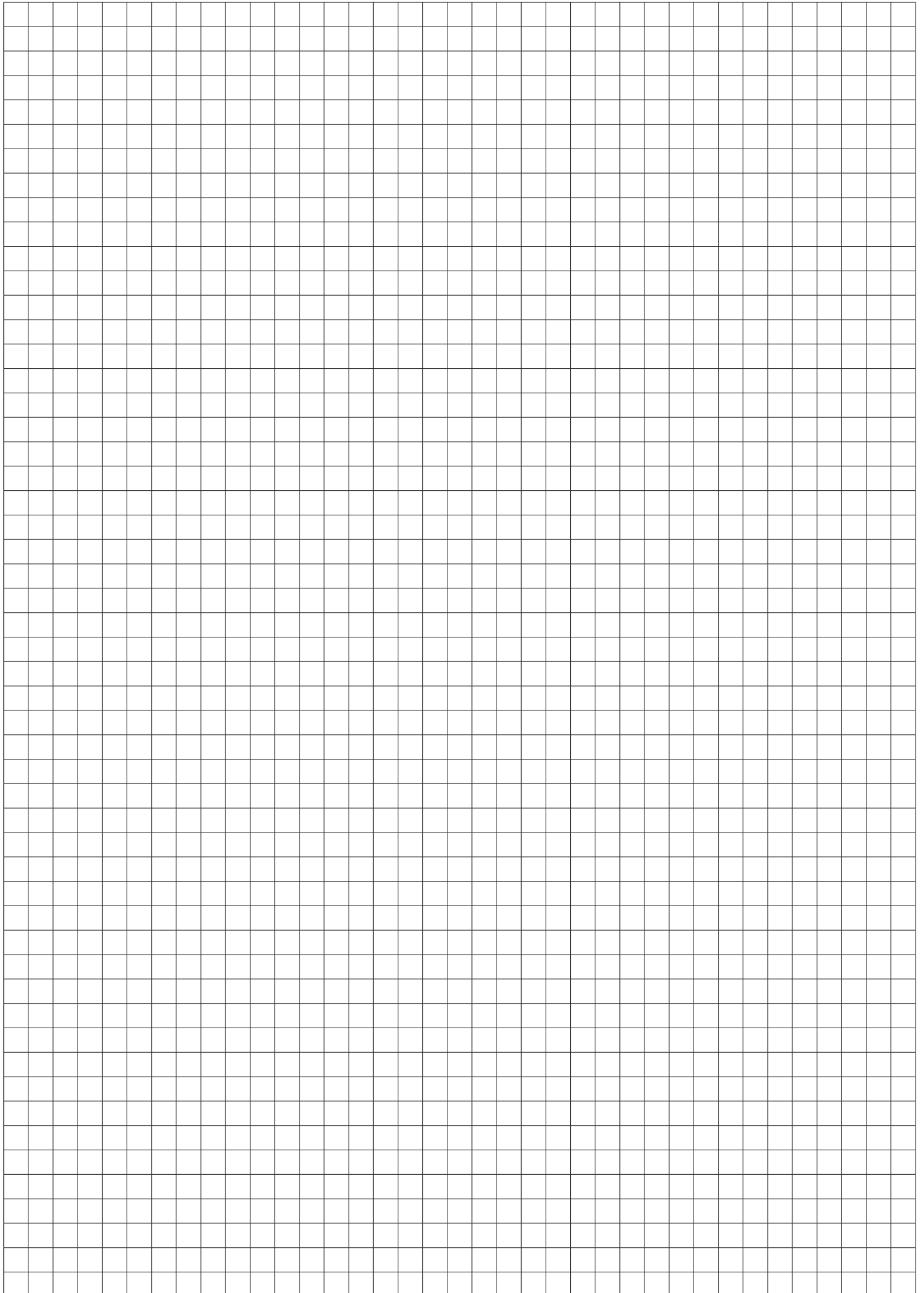

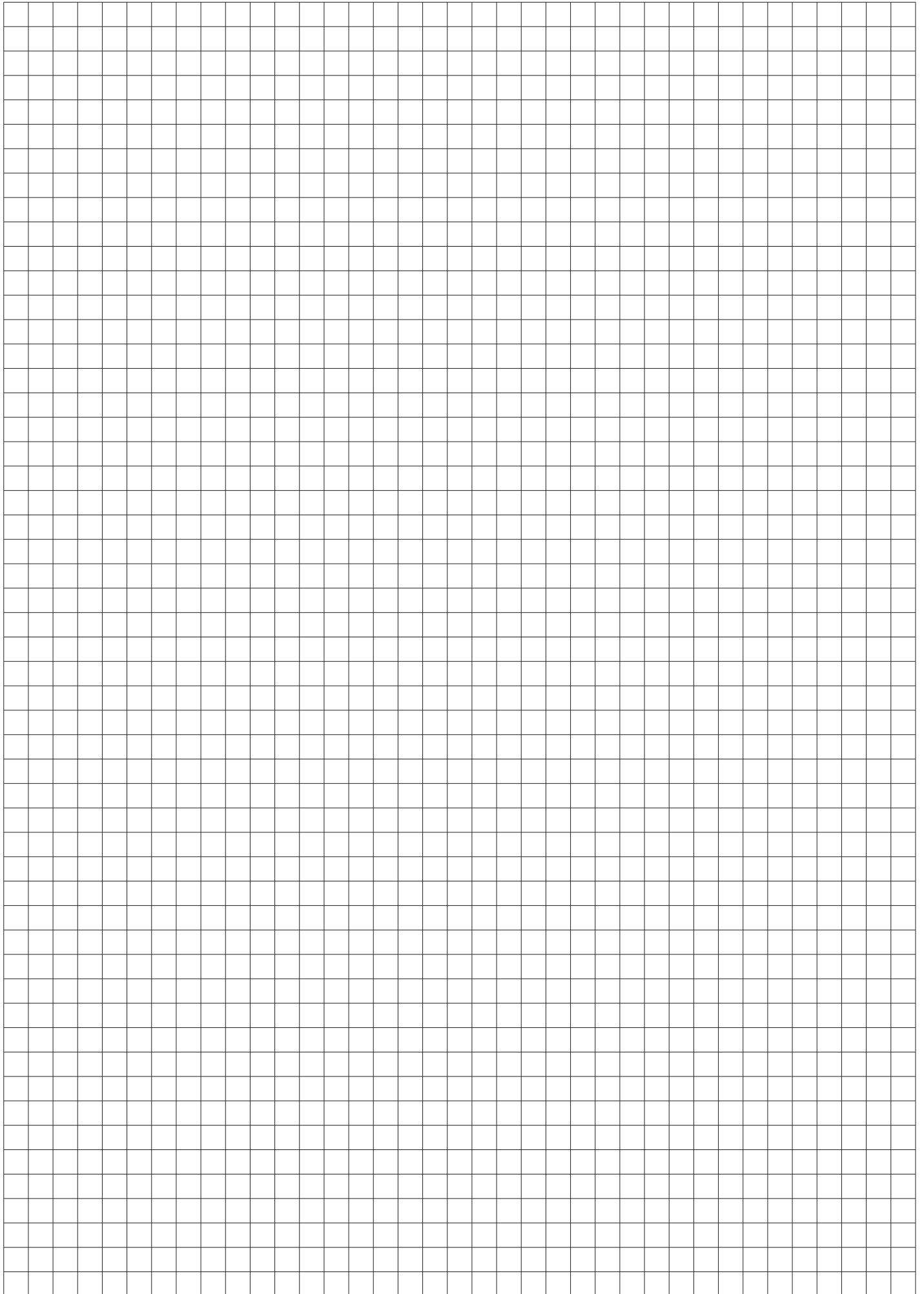

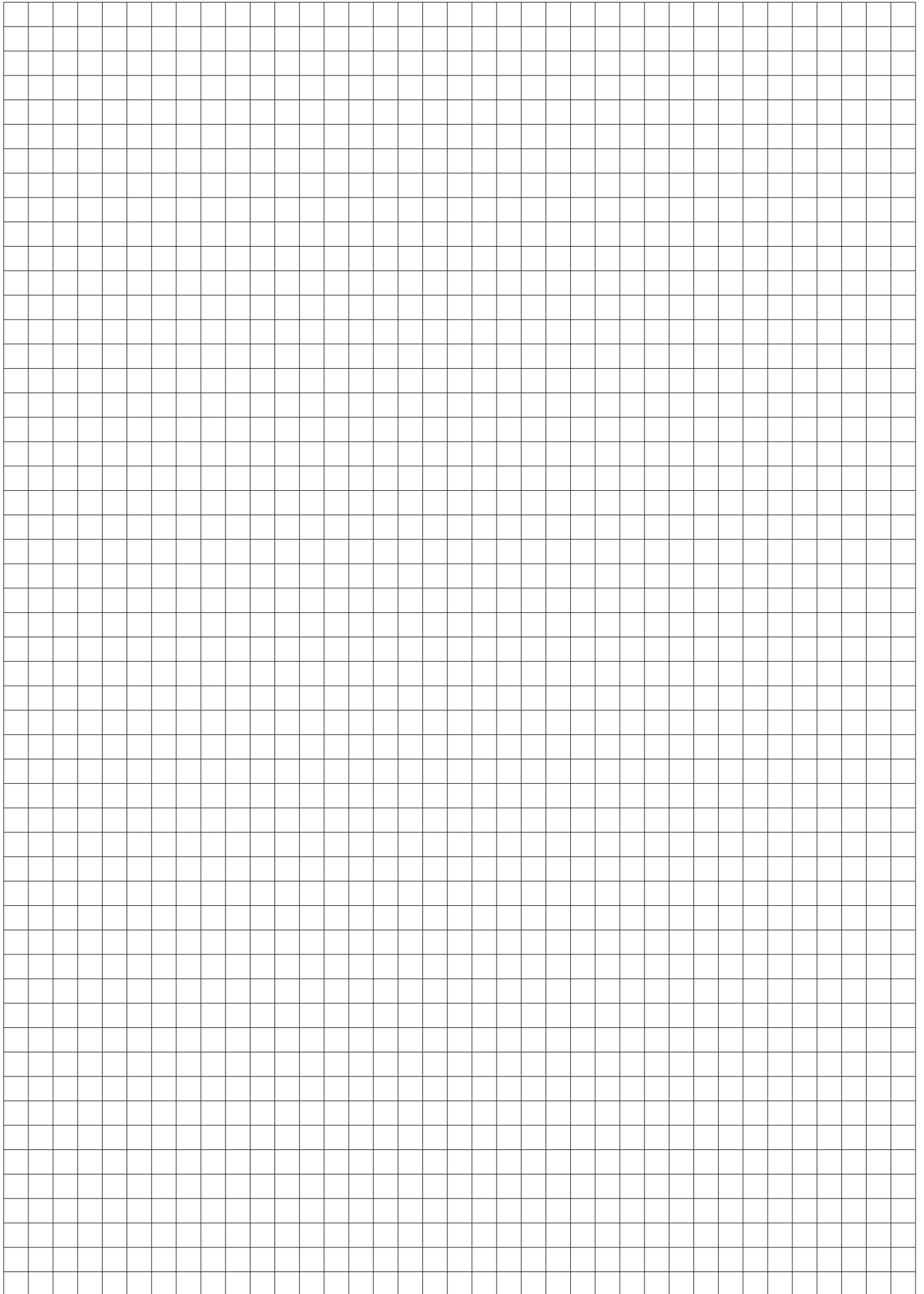

50 years in motorsports



www.beta-tools.com



Beta

Partnership 2017



Simone Corsi
Moto2 World Championship

